



Moulding Catalog



DOORS & WINDOWS

Backbands	1
Casings.	3
Flutings and Reedings	10
Stops	11
Plinths	12
Rosettes	16
Impost Blocks	19
Window Stools and Sills	20

WALLS & CEILINGS

Crowns and Pictures	23
Crown Backers	48
Crown Combinations	52
Chair Rails.	65
Panels	73
Corners, Inside and Outside	77
Ceilings and Panelings	81

FLOORS

Baseboards.	83
Base Caps	87
Thresholds and Floorings	90
Shoes.	92

MISCELLANEOUS

Bar Rails	93
Dentils	94
Door Jambs.	96
Glazings and Lattices.	97
Rounds	98
Mullions and Astragals.	100
Railings and Stairs.	101
S4S (Surfaced Four Sides)	104

EXTERIORS

Rakes	107
Brickmoulds and Drip Caps	108
Sidings	109
PVC Trim	111

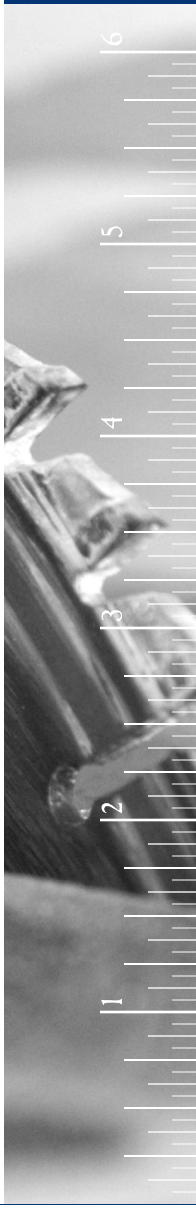

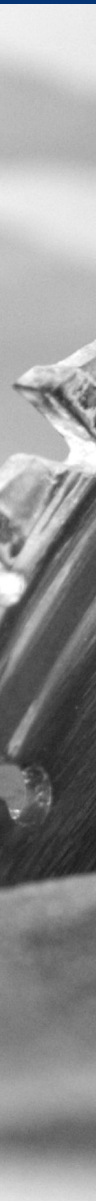

BACKBANDS

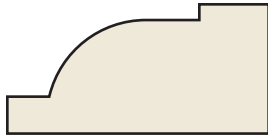

SM-9 Cox's Backband
11/16 × 1-3/8
Pine | STAIN GRADE | **SM9**

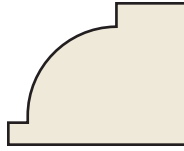

SM-10 Small Cox's Backband
3/4 × 15/16
Pine | STAIN GRADE | **SM010**

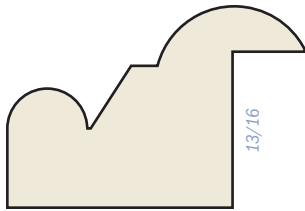

SM-60 Pine Picture Frame Mould
1-1/16 × 1-9/16
Poplar | FINGER JOINTED PRIMED | **POPPANSM60FPR**

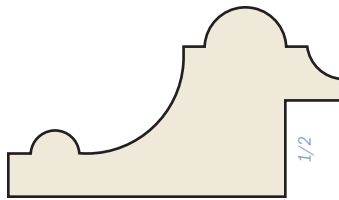

SM-62 Longwood Panel Mould
1 × 1-3/4
Cherry | STAIN GRADE | **SM62CH**
Maple | STAIN GRADE | **SM62M**
Oak, Red | STAIN GRADE | **SM62O**
Pine | STAIN GRADE | **SM62**
Poplar | FINGER JOINTED PRIMED | **POPPANSM62FPR**

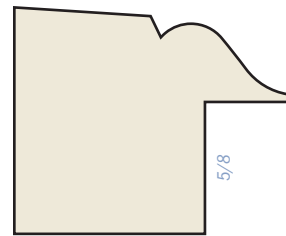

SM-68 Adams Backband
1-3/16 × 1-7/16
Pine | FINGER JOINTED PRIMED | **SM68FPR**
Pine | STAIN GRADE | **SM68**

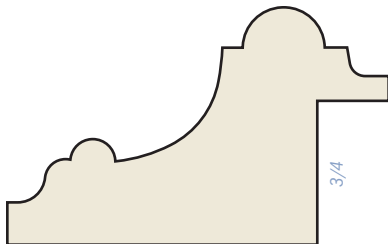

SM-64 Longwood Panel Mould
1-1/4 × 2
Poplar | SOLID PRIMED | **POPPANSM64FPR**

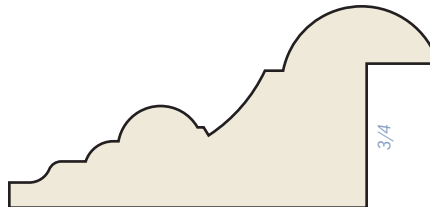

SM-143 Falcon Panel Mould
1-1/16 × 2-1/4
Poplar | FINGER JOINTED PRIMED | **POPPANSM143FPR**

SCALE: Actual Size

Doors & Hardware

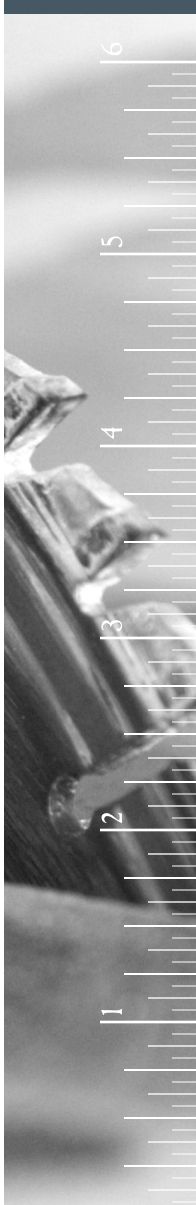

BACKBANDS

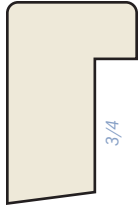

WM-280 Sanitary Backband
11/16 × 1-1/16
Pine | STAIN GRADE | WM280S

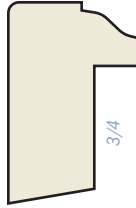

WM-281 Worked Backband
11/16 × 1-1/16
Pine | STAIN GRADE | WM281S

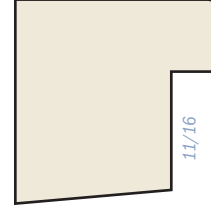

SM-9915 Backband
1-1/16 × 1-1/16
Poplar | FINGER JOINTED PRIMED | POPBBSM9915FPR

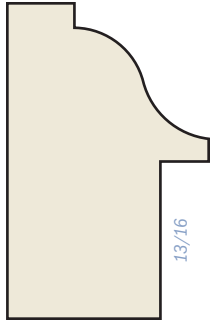

SM-848 Port Royal Backband
1-21/32 × 1-1/16
Poplar | SOLID PRIMED | POPBBEVS848PR

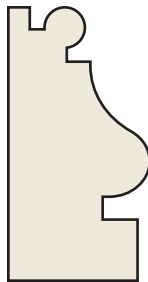

SM-865 Smoot Base Cap
3/4 × 1-7/16
Poplar | SOLID PRIMED | POPBCEVSM865PR

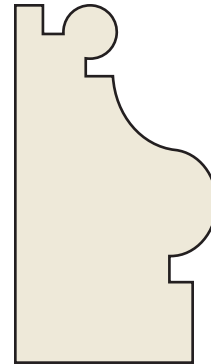

SM-867 Smoot Base Cap
1-1/16 × 1-7/8
Poplar | SOLID PRIMED | POPBCEVSM867PR

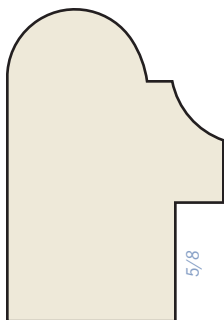

WP-288
1-1/16 × 1-5/8
Pine | FINGER JOINTED PRIMED | WM42P

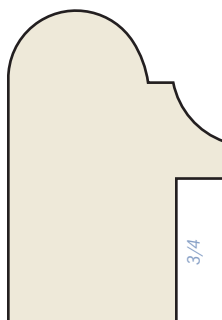

WP-288
1-1/16 × 1-5/8
Pine | STAIN GRADE | WM288S

SCALE: Actual Size

CASINGS

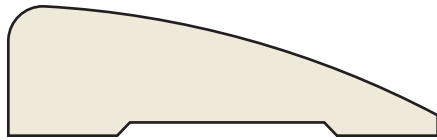

WM-327 Clamshell Casing

11/16 × 2-1/4

🌿 Pine | FINGER JOINTED PRIMED | WM327P
 🌿 Pine | STAIN GRADE | WM327S

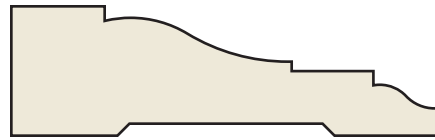

WM-366 Featheredge Casing

11/16 × 2-1/4

🌿 Pine | FINGER JOINTED PRIMED | WM366P

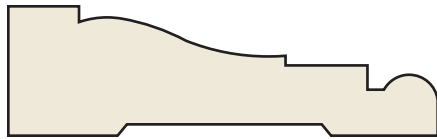

WM-376 Beaded Casing

11/16 × 2-1/4

🌿 Flex | 376FT40HR, 376FT5, 376FT60HR
 🌿 Pine | FINGER JOINTED PRIMED | WM376P
 🌿 Pine | STAIN GRADE | WM376S

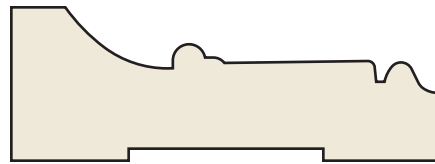

SM-106 Beaded Casing

13/16 × 2-1/4

🌿 Oak, Red | STAIN GRADE | SM106O



WM-472

9/16 × 2-1/2

🌿 Pine | FINGER JOINTED PRIMED | WM472P

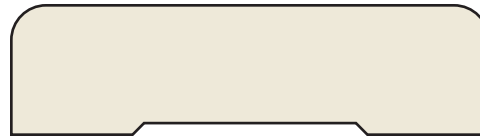

WM-452 Sanitary Casing

11/16 × 2-1/2

🌿 Pine | FINGER JOINTED PRIMED | WM452PE2E
 🌿 Pine | STAIN GRADE | WM452S

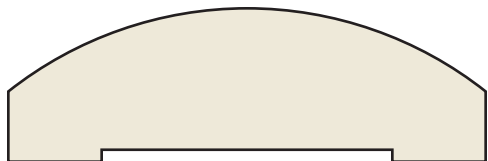

SM-74 Oval Casing

13/16 × 2-1/2

🌿 Poplar | FINGER JOINTED PRIMED | POPCSM74FPR

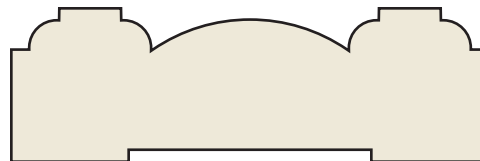

SM-102 Capitol Hill Casing

13/16 × 2-1/2

🌿 Poplar | FINGER JOINTED PRIMED | POPCSM102FPR



WM-371 Beaded Casing

11/16 × 2-1/2

🌿 Pine | FINGER JOINTED PRIMED | WM371P
 🌿 Pine | STAIN GRADE | WM371S

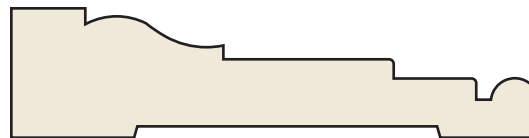

SM-82 Beaded Casing

11/16 × 2-3/4

🌿 Pine | FINGER JOINTED PRIMED | SM82FPR

📏 SCALE: Actual Size

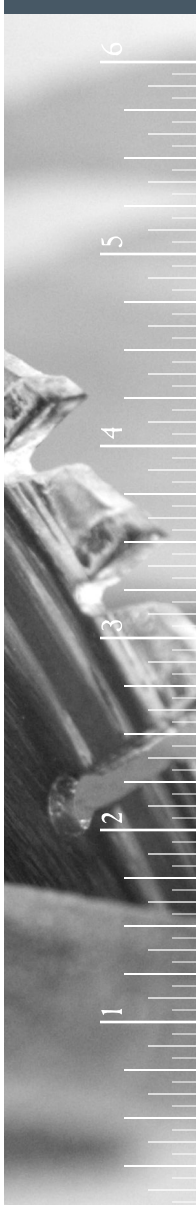

CASINGS

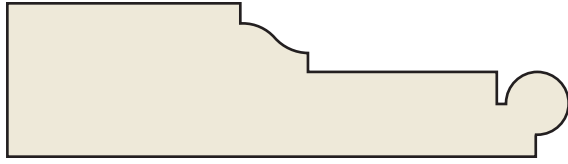

SM-880 Potomac Casing

13/16 × 2-15/16

Poplar | SOLID PRIMED | POPCSEVSM880PR

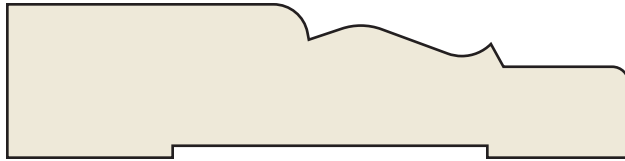

SM-1 Flatback Casing

13/16 × 3-1/4

Poplar | FINGER JOINTED PRIMED | POPCSM1FPR

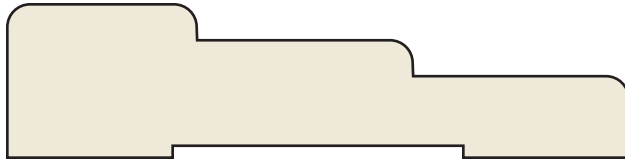

SM-683 Stepped Casing

13/16 × 3-1/4

Poplar | FINGER JOINTED PRIMED | POPCSM683FPR

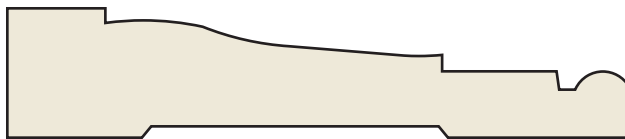

WM-445 Beaded Casing

11/16 × 3-1/4

Flex | 445FT30HR, 445FT50HR, 445FT60HR

Pine | FINGER JOINTED PRIMED | WM445P

Pine | STAIN GRADE | WM445S

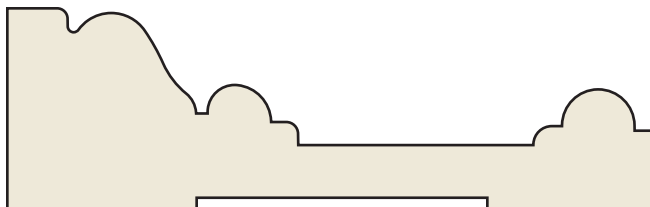

SM-3 Grady Casing

1-1/16 × 3-3/8

Pine | FINGER JOINTED PRIMED | SM3FPR

SCALE: Actual Size

CASINGS

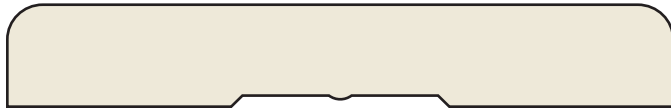

WM-432
 9/16 × 3-1/2
 Pine | FINGER JOINTED PRIMED | WM432P
 Pine | STAIN GRADE | WM432S

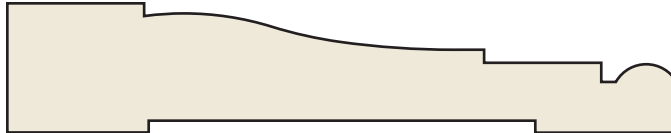

LWM-445 Beaded Casing
 11/16 × 3-1/2
 Pine | FINGER JOINTED PRIMED | LWM445P
 Pine | STAIN GRADE | LWM445S



SM-9920
 11/16 × 3-1/2
 Poplar | FINGER JOINTED PRIMED | POPCSSM9920FPR

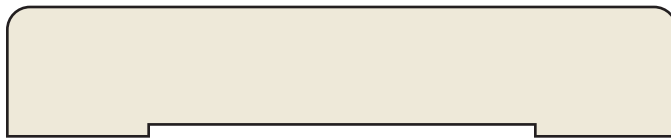

WM-412 Sanitary Casing
 11/16 × 3-1/2
 Pine | FINGER JOINTED PRIMED | WM412P

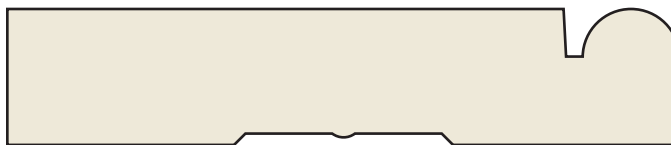

9750M Casing
 11/16 × 3-1/2
 MDF | SOLID PRIMED | 9750MDF16

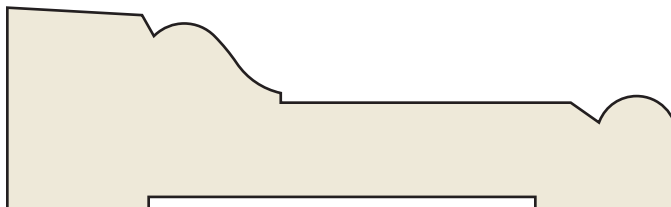

SM-4 Adams Casing
 1-1/16 × 3-1/2
 Flex | SM4FT40HR, SM4FT60HR
 Pine | FINGER JOINTED PRIMED | SM4FPR
 Pine | STAIN GRADE | SM4

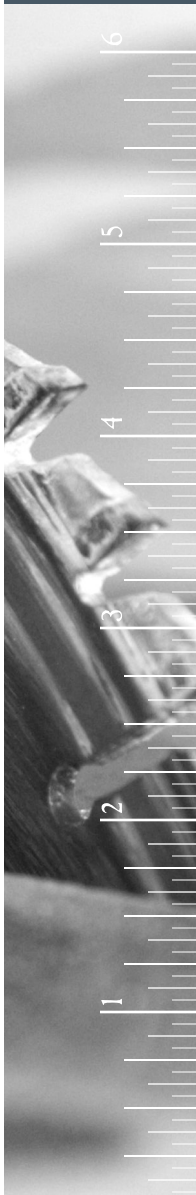

SCALE: Actual Size

CASINGS

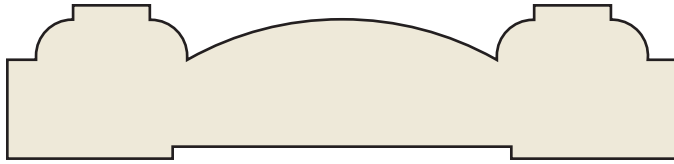

SM-79 Capitol Hill Casing

13/16 × 3-1/2

Poplar | FINGER JOINTED PRIMED | POPCSM79FPR

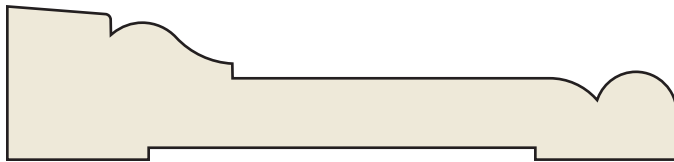

SM-444 Scant Adams

13/16 × 3-1/2

Cherry | STAIN GRADE | SM444CH
 Maple | STAIN GRADE | WM444MAP
 Oak, Red | STAIN GRADE | SM444RO
 Poplar | FINGER JOINTED PRIMED | POPCSM444FPR

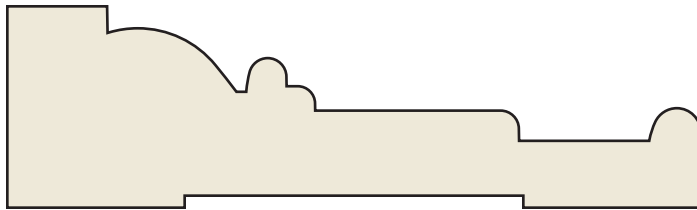

SM-2 Round Hill Casing

1-1/16 × 3-5/8

Poplar | FINGER JOINTED PRIMED | POPCSM2FPR

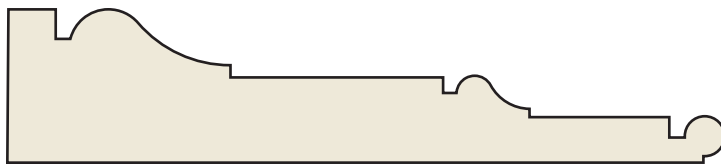

SM-886 Chatham Casing

13/16 × 3-3/4

Poplar | SOLID PRIMED | POPCSEVSM886PR

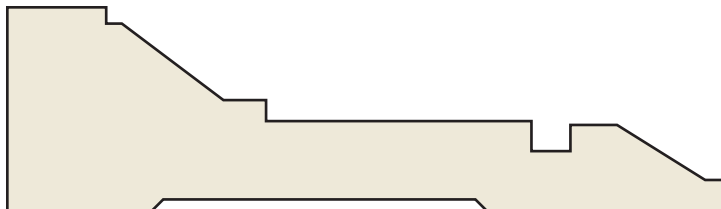

SM-9925

1-1/16 × 3-3/4

Poplar | FINGER JOINTED PRIMED | POPCSSM9925FPR

SCALE: Actual Size

CASINGS

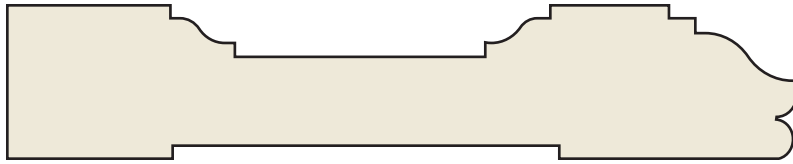

SM-83
 13/16 × 4-1/8
 Poplar | FINGER JOINTED PRIMED | POPCSM83FPR

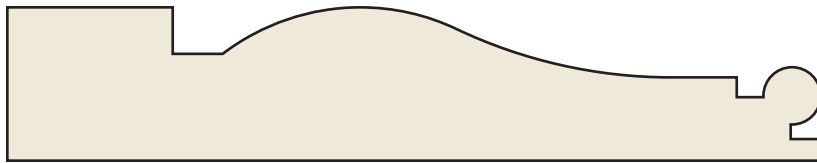

SM-890 Lee Casing
 13/16 × 4-1/4
 Poplar | SOLID PRIMED | POPCSEVSM890PR

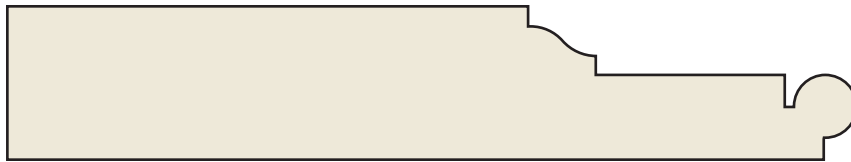

SM-881 Potomac Casing
 13/16 × 4-7/16
 Poplar | SOLID PRIMED |
 POPCSEVSM881PR

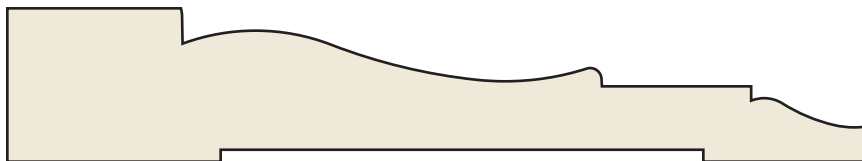

SM-6 Featheredge Casing
 13/16 × 4-1/2
 Poplar | FINGER JOINTED PRIMED |
 POPCSM6FPR

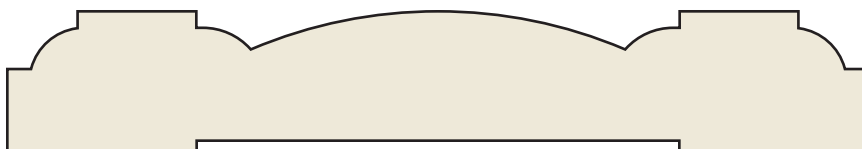

SM-7 Capitol Hill Casing
 13/16 × 4-1/2
 Pine | STAIN GRADE | SM07
 Poplar | FINGER JOINTED PRIMED |
 POPCSM7FPR

SCALE: Actual Size

Doors & Windows

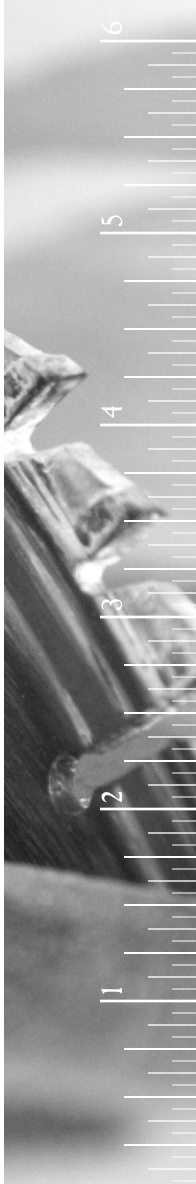

CASINGS

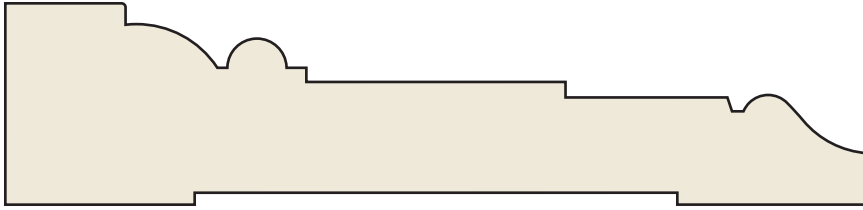

SM-12 Foxhall Casing

1-1/16 × 4-1/2

🌲 Pine | STAIN GRADE | **SM12**

🌲 Poplar | FINGER JOINTED PRIMED | **POPCSM12FPR**

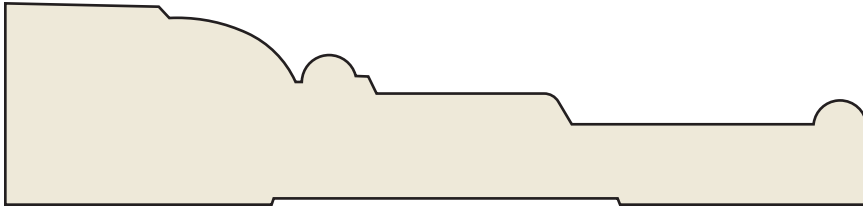

SM-46 Round Hill Casing

1-1/16 × 4-1/2

🌲 Poplar | FINGER JOINTED PRIMED | **POPCSM46FPR**

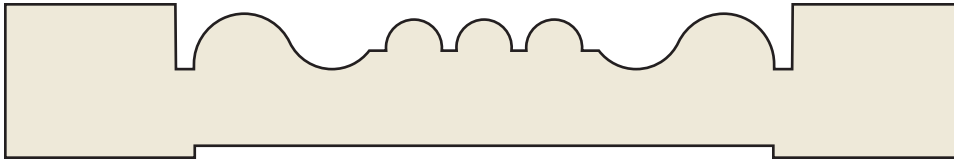

SM-8 Franklin Casing

13/16 × 5

🌲 Poplar | FINGER JOINTED PRIMED | **POPCSM8FPR**

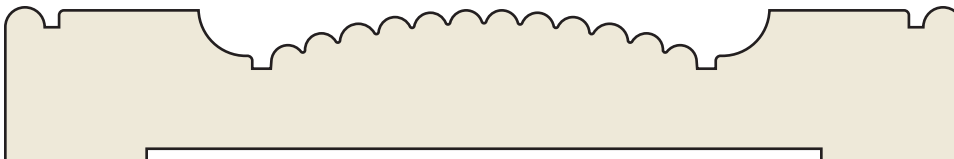

SM-80 Caroline Casing

13/16 × 5

🌲 Poplar | FINGER JOINTED PRIMED | **POPCSM80FPR**

📏 SCALE: Actual Size

CASINGS

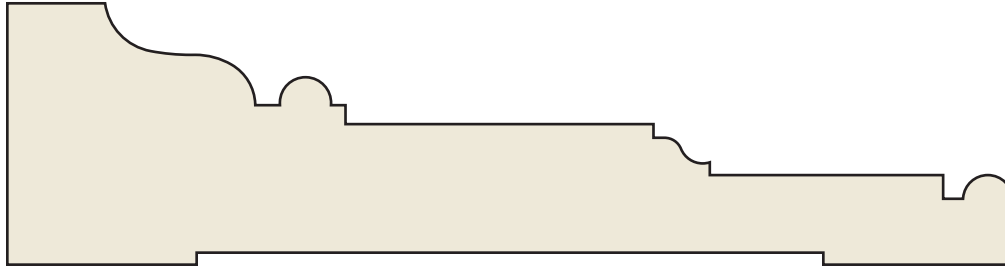

SM-84 Georgian Casing

1-3/8 × 5-1/4

Poplar | SOLID PRIMED | POPCSM84PR

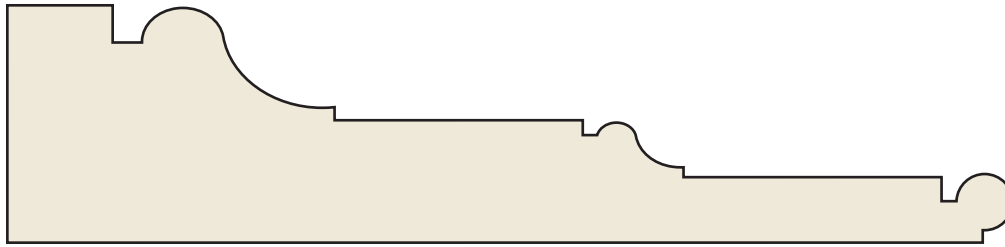

SM-887 Chatham Casing

1-1/4 × 5-1/4

Poplar | SOLID PRIMED | POPCSEVM887PR

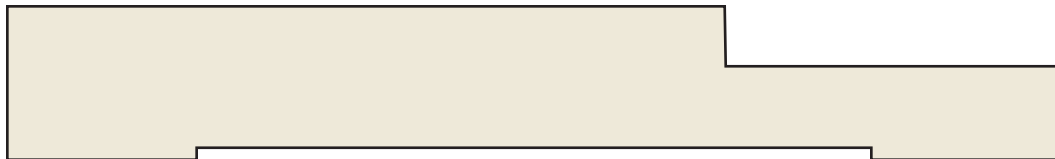

SM-97

13/16 × 5-1/2

Poplar | FINGER JOINTED PRIMED | POPBSM97FPR

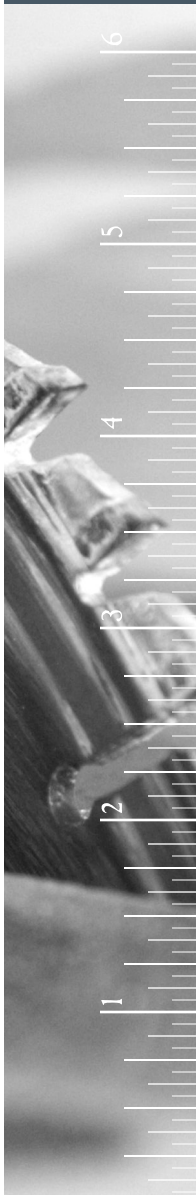

SCALE: Actual Size

FLUTINGS AND REEDINGS

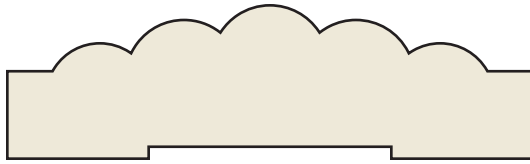

SM-76 Reeded Casing

13/16 × 2-3/4

🌿 Poplar | FINGER JOINTED PRIMED | POPCSM76FPR



SM-77 Reversible Fluting/Reeding

11/16 × 3-1/4

🌿 Pine | FINGER JOINTED PRIMED | SM77FPR

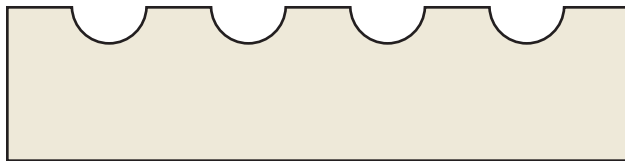

SM-160 Fluting

13/16 × 3-1/4

🌿 Oak, Red | STAIN GRADE | F1600

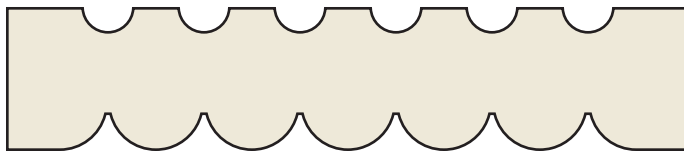

SM-5 Reversible Fluting/Reeding

13/16 × 3-9/16

🌿 Poplar | FINGER JOINTED PRIMED | POPCSM5FPR

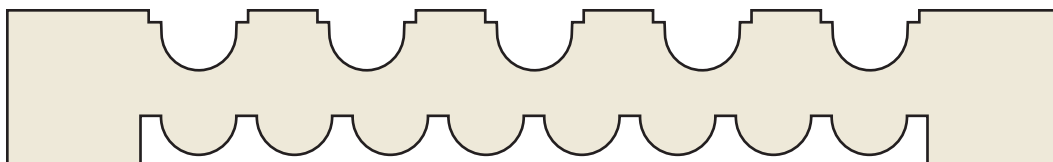

SM-85 Reversible Fluting/Reeding

13/16 × 5-1/2

🌿 Poplar | FINGER JOINTED PRIMED | POPCSM85FPR

📏 SCALE: Actual Size

STOPS



LWM-951 Ogee Stop
3/8 × 5/8
Pine | STAIN GRADE | **WM951S**

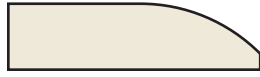

WM-826 Clamshell Stop
3/8 × 1-3/8
Pine | STAIN GRADE | **WM826S**



SM-303 Ogee
7/16 × 1-3/8
Cherry | STAIN GRADE | **SM303CH**
Maple | STAIN GRADE | **SM303M**
Oak, Red | STAIN GRADE | **SM303O**



WM-886 Sanitary Stop
3/8 × 1-3/8
Pine | FINGER JOINTED PRIMED | **WM886P**

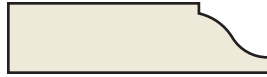

WM-946 Ogee Stop
3/8 × 1-3/8
Pine | STAIN GRADE | **WM946S**

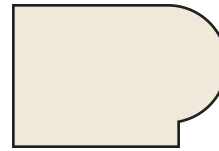

SM-52 Bullnose Stop
3/4 × 1-1/8
Pine | STAIN GRADE | **SM52**

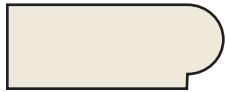

LWM-953 Bullnose Stop
7/16 × 1-1/8
Pine | STAIN GRADE | **WM953S**

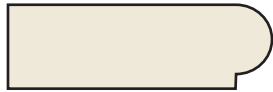

LWM-954P Sash Bead
7/16 × 1-3/8
Pine | FINGER JOINTED PRIMED | **WM954P**

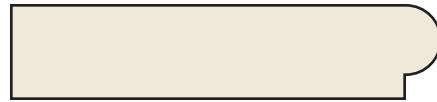

SM-50 Bullnose Stop
1/2 × 2-1/4
Pine | FINGER JOINTED PRIMED | **SM50FPR**

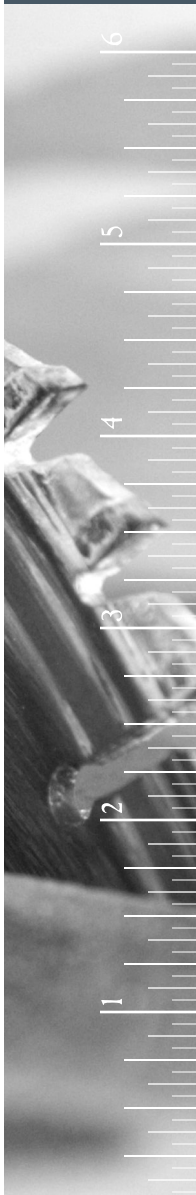

SCALE: Actual Size

PLINTHS

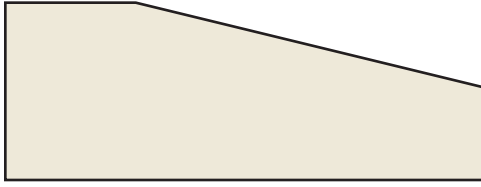

SM-11 Plinth for 2-1/4 Casings

15/16 × 2-1/2

🌿 Poplar | SOLID PRIMED | POPPLSM11PR

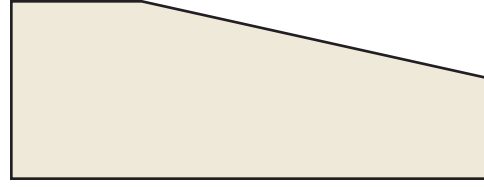

SM-13 Plinth for 2-1/2 Casings

15/16 × 2-3/4

🌿 Poplar | SOLID PRIMED | POPPLSM13PR

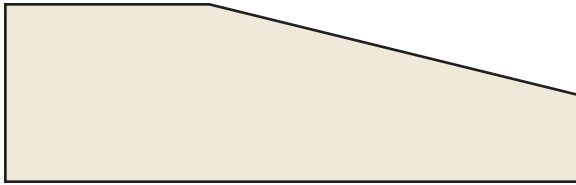

SM-87 Plinth for 2-3/4 Casings

15/16 × 3

🌿 Poplar | SOLID PRIMED | POPPLSM87PR

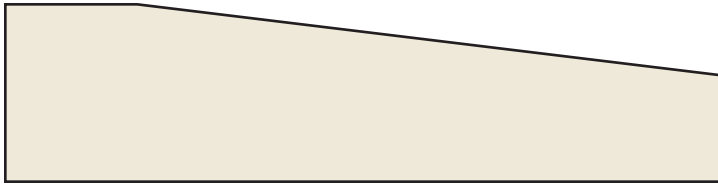

SM-15 Plinth for 3-1/2 Casings

15/16 × 3-3/4

🌿 Poplar | SOLID PRIMED | POPPLSM15PR

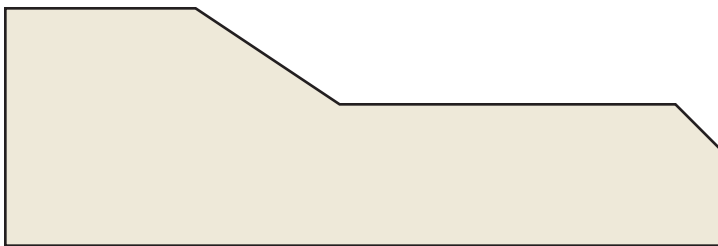

SM-89 Plinth for SM-2, SM-3, and SM-4

1-1/4 × 3-3/4

🌿 Poplar | SOLID PRIMED | POPPLSM89PR

📏 SCALE: Actual Size

PLINTHS

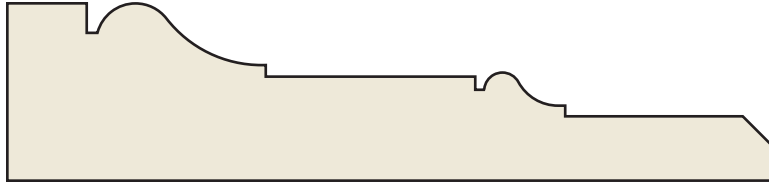

SM-886P Chatham Plinth

15/16 × 4

Poplar | SOLID PRIMED | POPPLEVSM886PPR

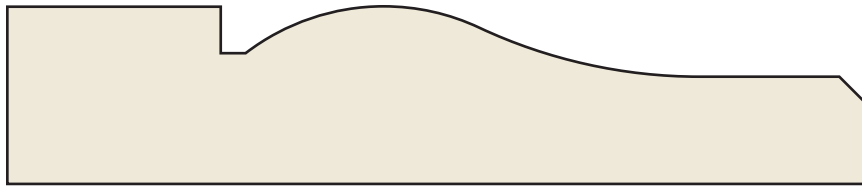

SM-890P Lee Plinth

15/16 × 4-1/2

Poplar | SOLID PRIMED | POPBCEVSM890PR



SM-16 Plinth for SM-6, SM-7 and SM-83

15/16 × 4-3/4

Poplar | SOLID PRIMED | POPPLSM16PR

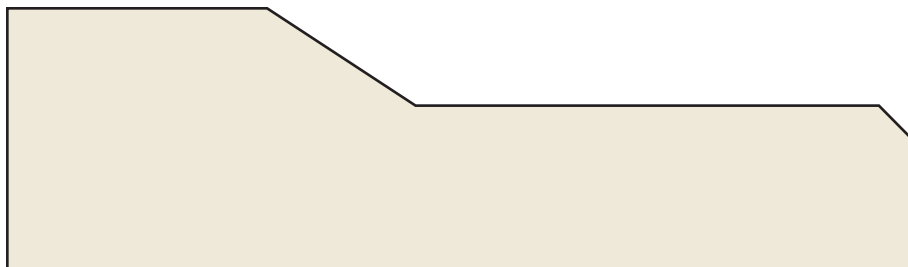

SM-100 Plinth for SM-12 and SM-46

1-3/8 × 4-3/4

Poplar | SOLID PRIMED | POPPLSM100PR



SCALE: Actual Size

PLINTHS

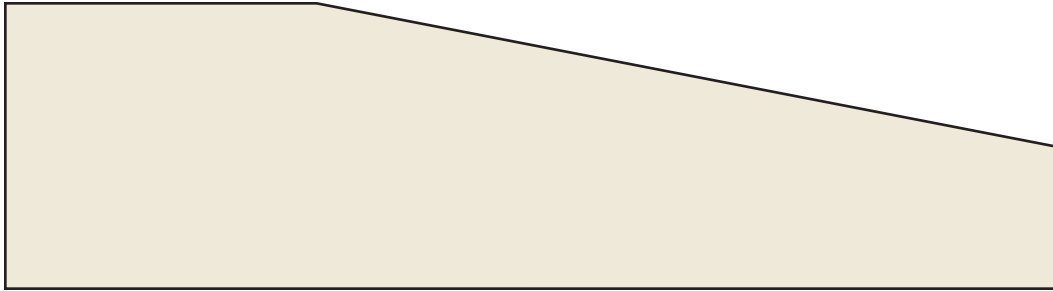

SM-99 Georgian Plinth for SM-84

1-1/2 × 5-1/2

🌿 Poplar | SOLID PRIMED | POPPLSM99PR

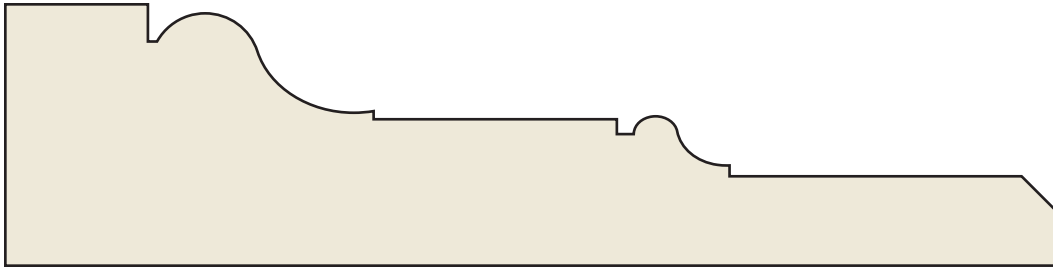

SM-887P Chatham Plinth

1-3/8 × 5-1/2

🌿 Poplar | SOLID PRIMED | POPPLEVSM887PPR

📏 SCALE: Actual Size

PLINTHS

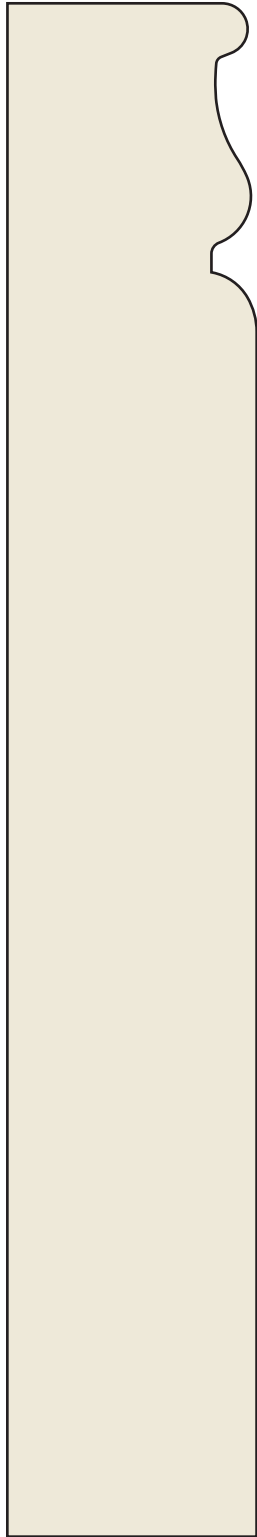

SM-744 Plinth
1-5/16 × 8
Poplar | SOLID PRIMED | POPPLSM744PR



SM-188 Franklin Plinth
1-1/8 × 10
Poplar | SOLID PRIMED | POPPLSM188PR

SCALE: Actual Size

Doors & Windows

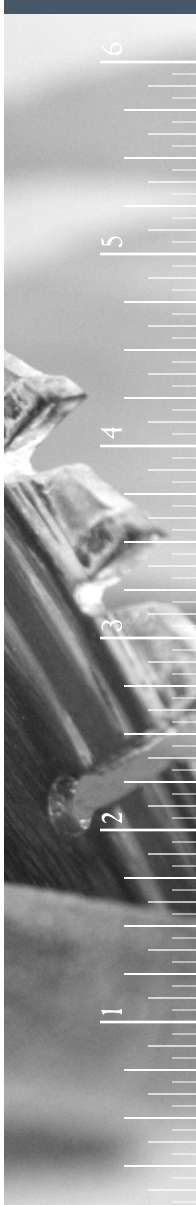

ROSETTES

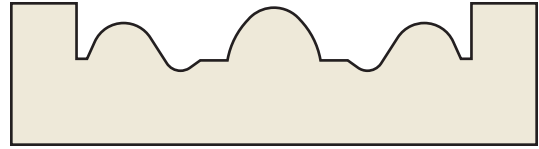
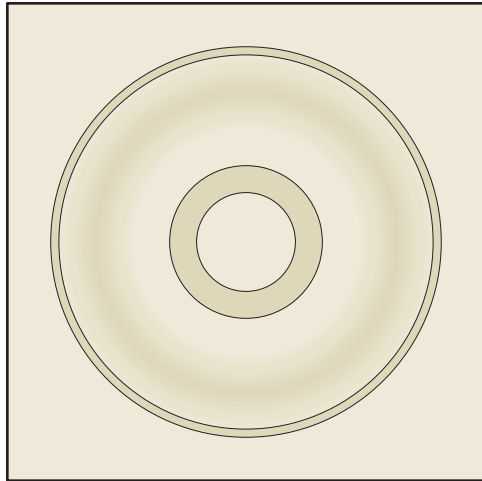

SM-18 Rosette
 $15/16 \times 2-3/4 \times 2-3/4$
 Pine | STAIN GRADE | **SM18**



SM-14 Rosette
 $15/16 \times 3 \times 3$
 Pine | STAIN GRADE | **SM14**

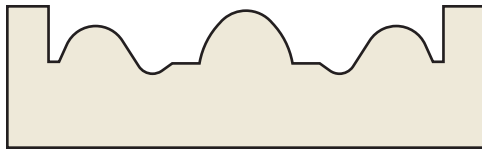

SM-17 Rosette
 $15/16 \times 2-1/2 \times 2-1/2$
 Pine | STAIN GRADE | **SM17**

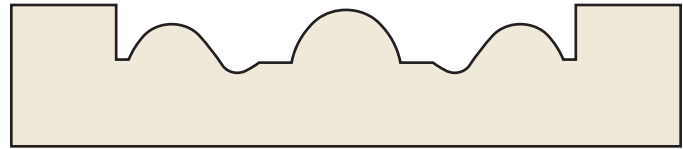

SM-124 Rosette
 $15/16 \times 3-1/2 \times 3-1/2$
 Pine | STAIN GRADE | **SM124**



SM-19 Rosette
 $15/16 \times 3-3/4 \times 3-3/4$
 Cherry | STAIN GRADE | **SM19CH**
 Maple | STAIN GRADE | **SM19M**
 Oak, Red | STAIN GRADE | **SM19O**
 Pine | STAIN GRADE | **SM19**

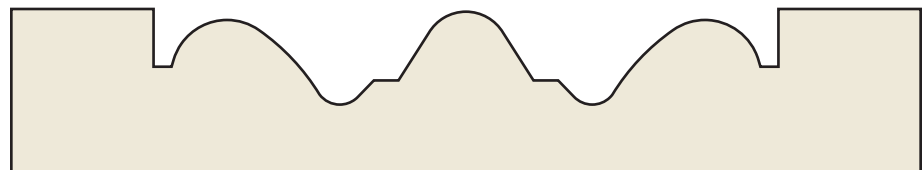

SM-20 Rosette
 $15/16 \times 4-3/4 \times 4-3/4$
 Pine | STAIN GRADE | **SM20R**

SCALE: Actual Size

ROSETTES

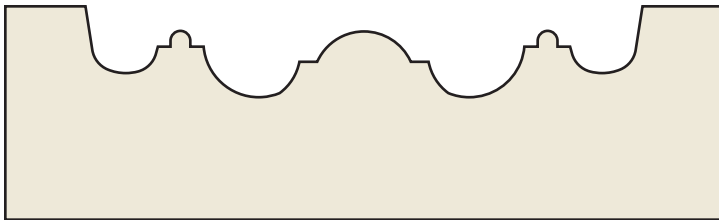
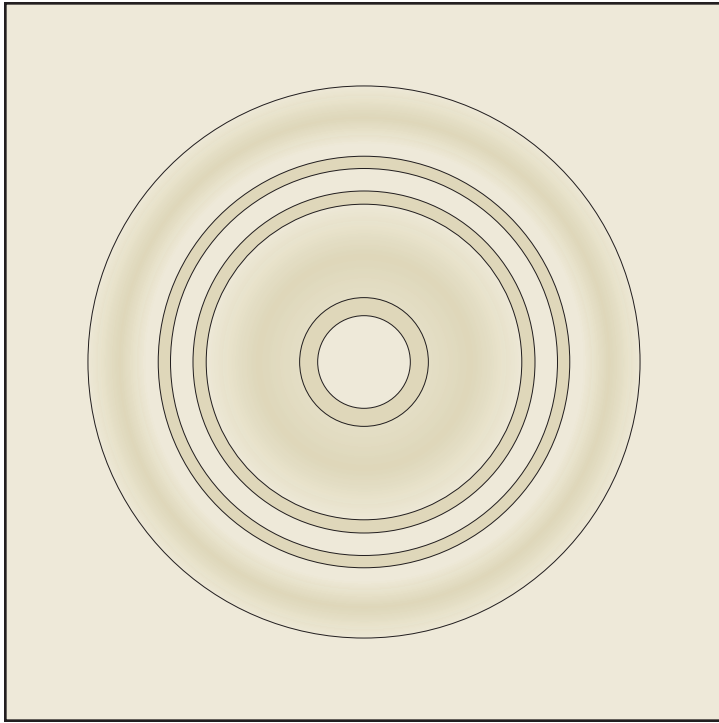

SM-48 Adams Rosette
1-1/8 × 3-3/4 × 3-3/4
Pine | STAIN GRADE | SM48

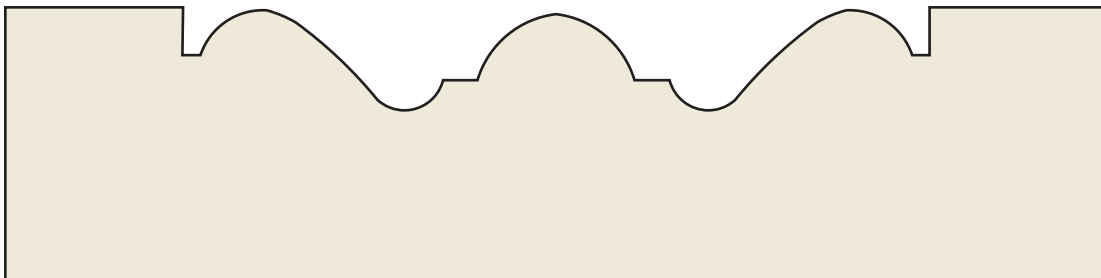

SM-103 Georgian Rosette for SM-84
1-1/2 × 5-1/2 × 5-1/2
Pine | STAIN GRADE | SM103

SCALE: Actual Size

Doors & Windows

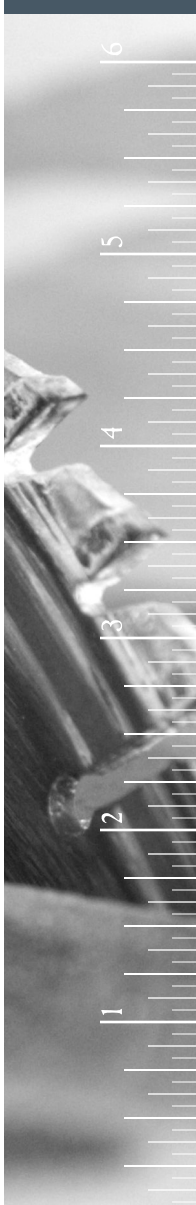

ROSETTES

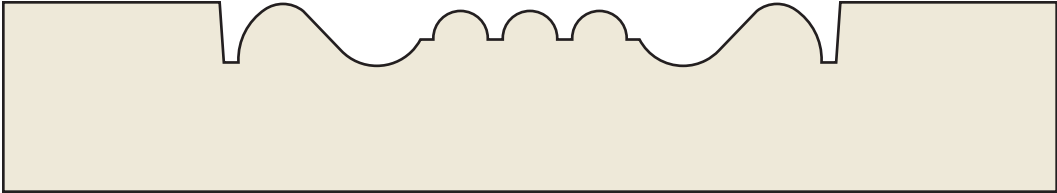
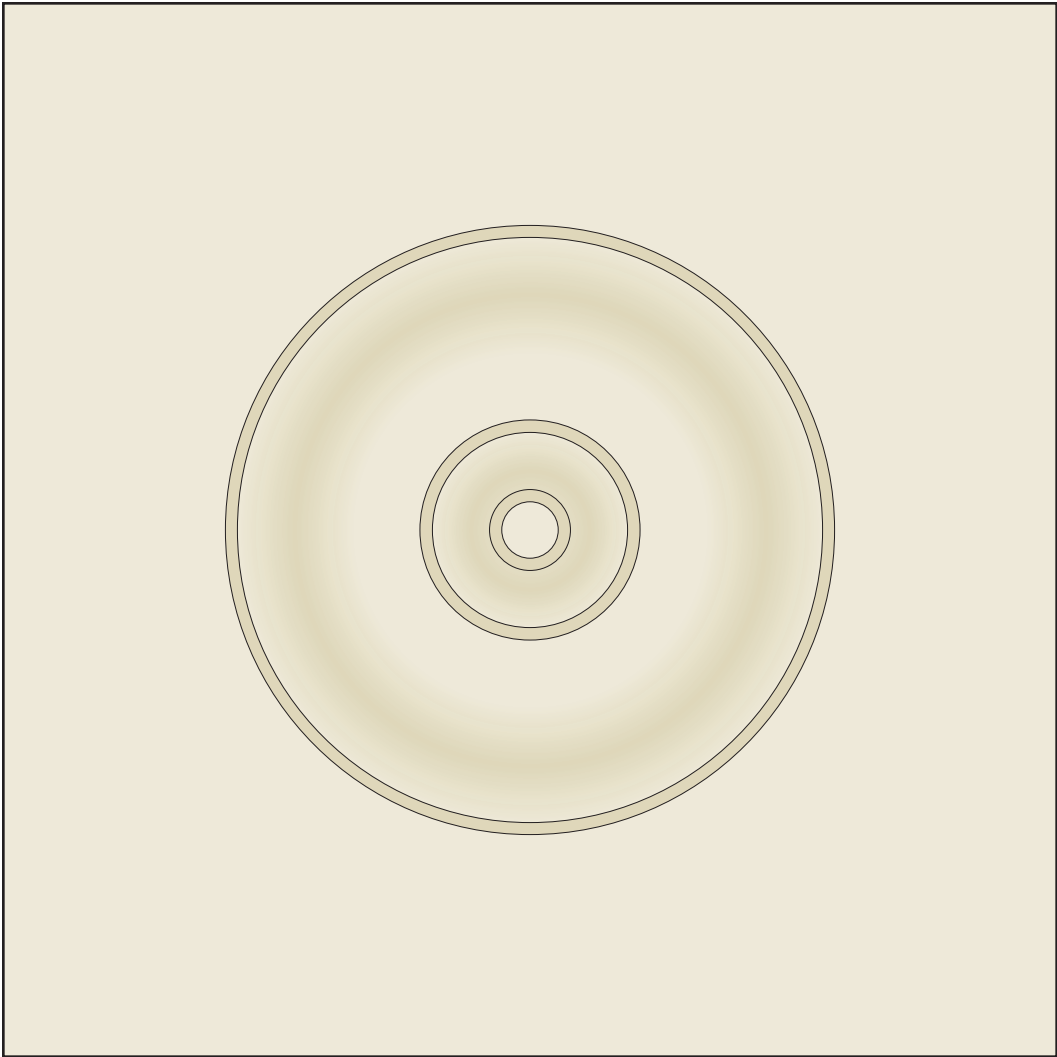

SM-78 Franklin Rosette

1 x 5-1/2 x 5-1/2

Pine | STAIN GRADE | SM78

SCALE: Actual Size

IMPOST BLOCKS

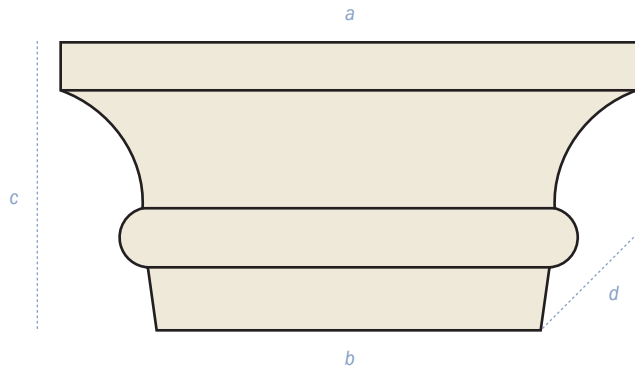

	<i>a</i> Top Width	<i>b</i> Bottom Width	<i>c</i> Overall Height	<i>d</i> Bottom Depth
SM-880 SM880	3-1/2	2-1/2	1-1/2	7/8
SM-883 SM883	4-3/4	3-3/4	1-1/2	7/8
SM-886 SM886	4-3/4	3-3/4	1-1/2	1-1/8
SM-889 SM889	5-3/4	4-3/4	1-1/2	1-1/8
SM-892 SM892	6-1/2	5-1/2	1-1/2	1-1/2
SM-895 SM895	6-3/4	5-3/4	1-1/2	7/8

Pine | STAIN GRADE

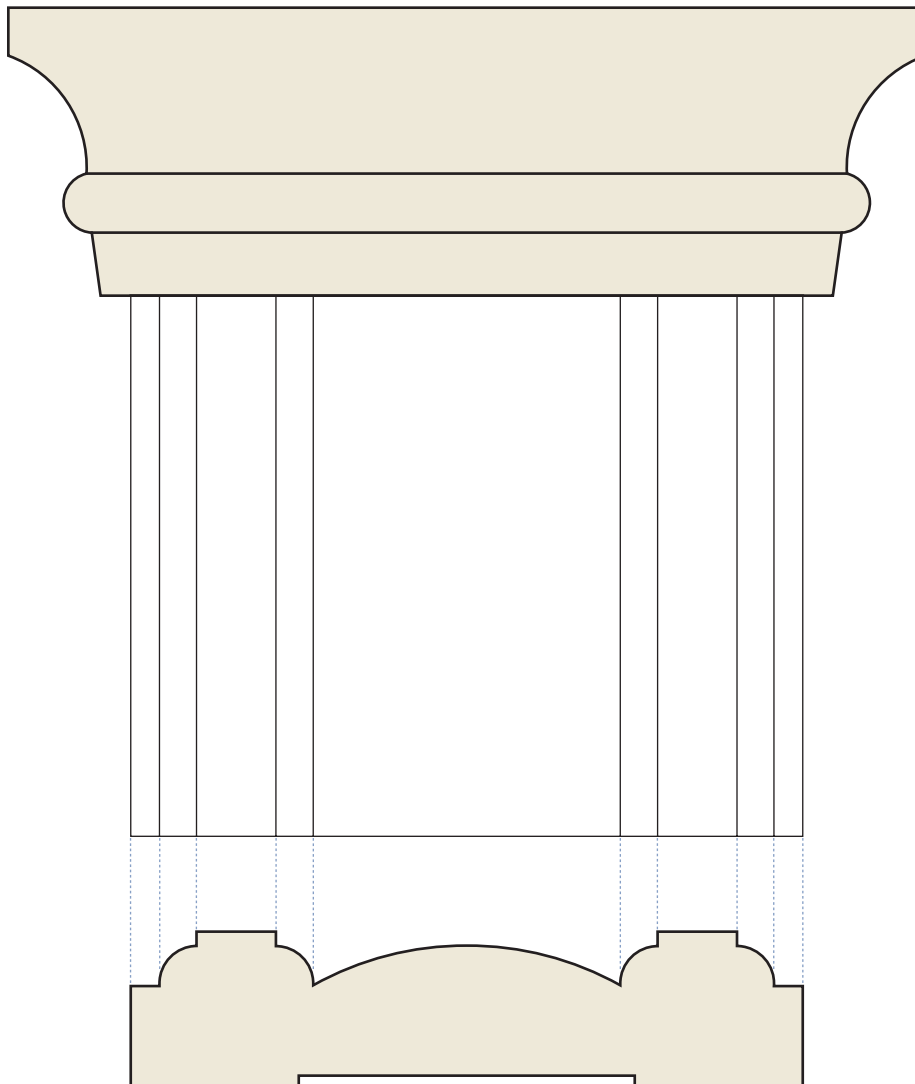

SCALE: Actual Size

Doors & Windows

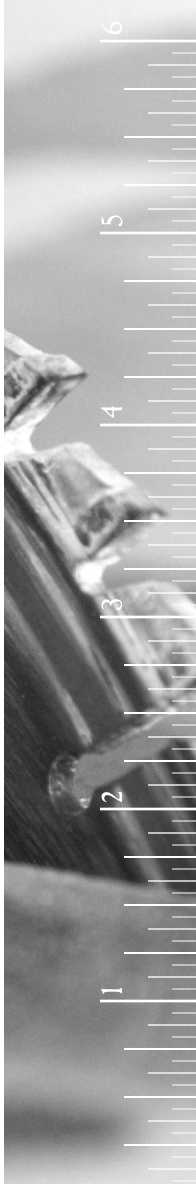

WINDOW STOOLS AND SILLS



WM-1021 Window Stool

11/16 × 5-1/4

 Pine | FINGER JOINTED PRIMED | WM1021P

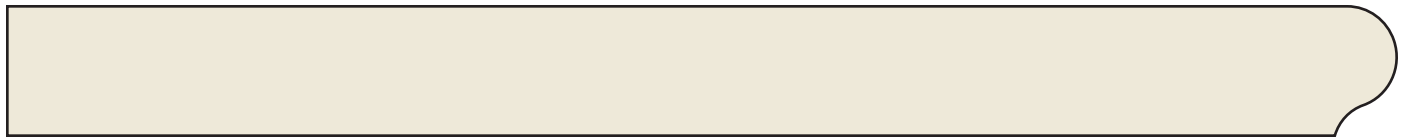

WM-1021P Window Stool

11/16 × 7-1/4

 Pine | FINGER JOINTED PRIMED | WM1021WP

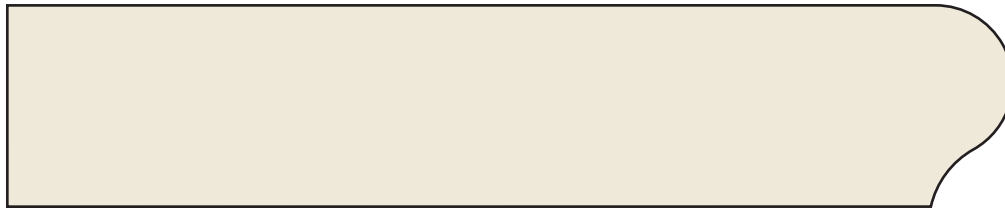

LWM-1021 Window Stool

1-1/16 × 5-1/4

 Pine | FINGER JOINTED PRIMED | LWM1021P

 SCALE: Actual Size

WINDOW STOOLS AND SILLS

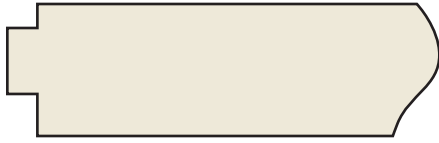

WM-1197T Stool

11/16 × 2-1/4

- Pine | FINGER JOINTED PRIMED | **WM1197BP**
- Pine | STAIN GRADE | **WM1197TBP**

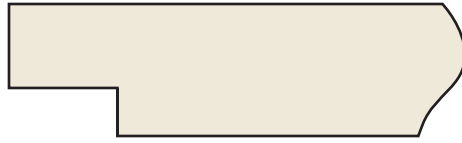

WM-1197 Anderson Stool

11/16 × 2-3/8

- Pine | FINGER JOINTED PRIMED | **WM1197F**

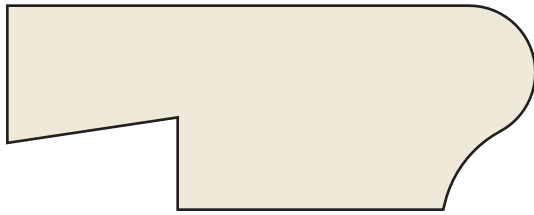

WM-1164 Rabbeted Window Sill

1-1/16 × 2-3/4

- Pine | FINGER JOINTED PRIMED | **WM1164F**

SM-773 Window Sill Nosing

1-1/4 × 1-5/8

- Pine, Eastern White | SOLID PRIMED | **SM773FPR**

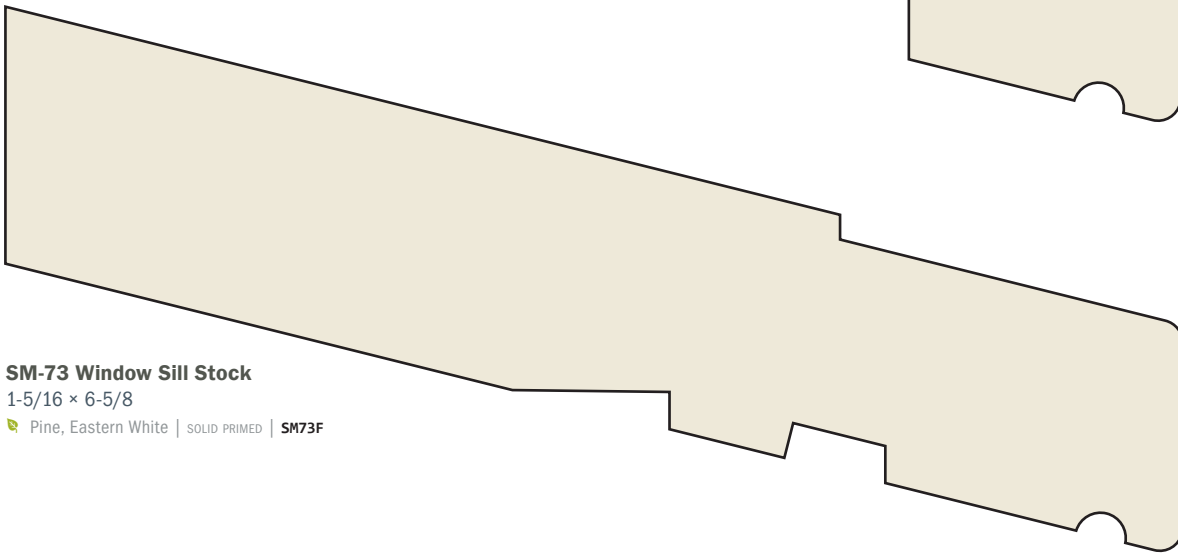
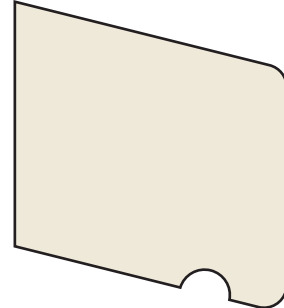

SM-73 Window Sill Stock

1-5/16 × 6-5/8

- Pine, Eastern White | SOLID PRIMED | **SM73F**

SCALE: Actual Size

Doors & Windows

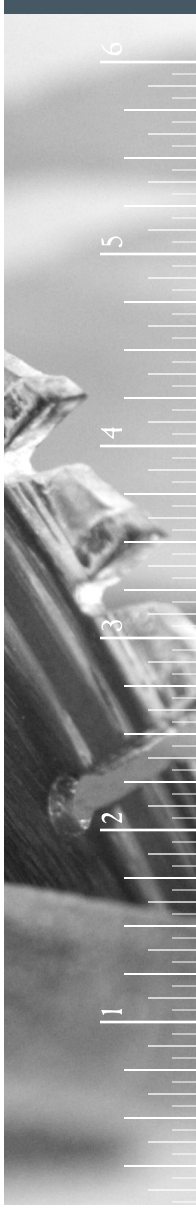

WINDOW STOOLS AND SILLS

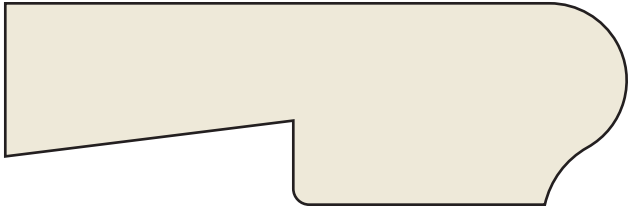

SM-554 Rabbeted Window Stool

1-1/16 × 3-1/4

 Oak, Red | STAIN GRADE | **SM5540**



WM-1163 Rabbeted Window Sill

1-1/16 × 3-1/4

 Pine | FINGER JOINTED PRIMED | **WM1163P**

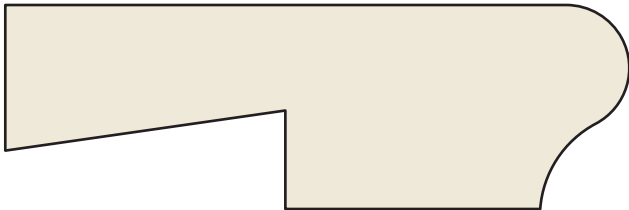

LWM-1163 Rabbeted Window Sill

1-1/16 × 3-1/4

 Pine | STAIN GRADE | **WM1163S**

 SCALE: Actual Size

CROWNS AND PICTURES

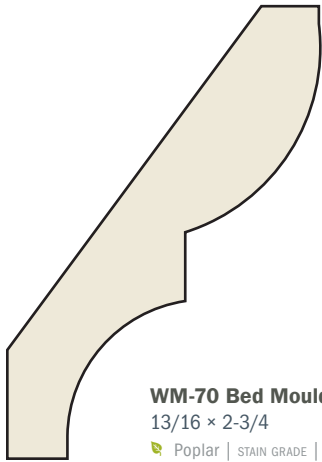

WM-70 Bed Mould
 13/16 × 2-3/4
 Poplar | STAIN GRADE | POPCR70FPR

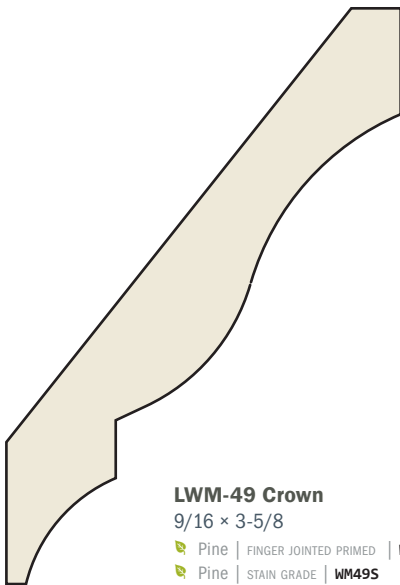
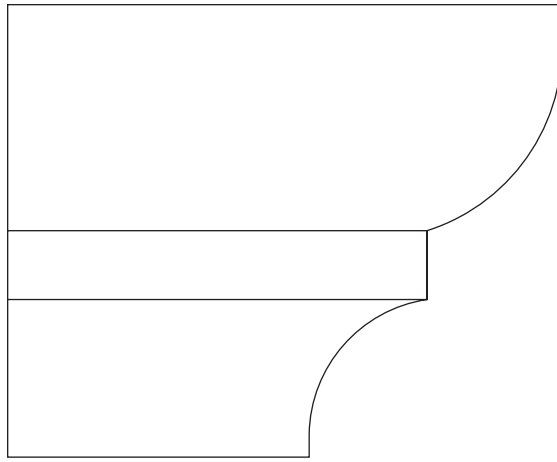

LWM-49 Crown
 9/16 × 3-5/8
 Pine | FINGER JOINTED PRIMED | WM49P
 Pine | STAIN GRADE | WM49S

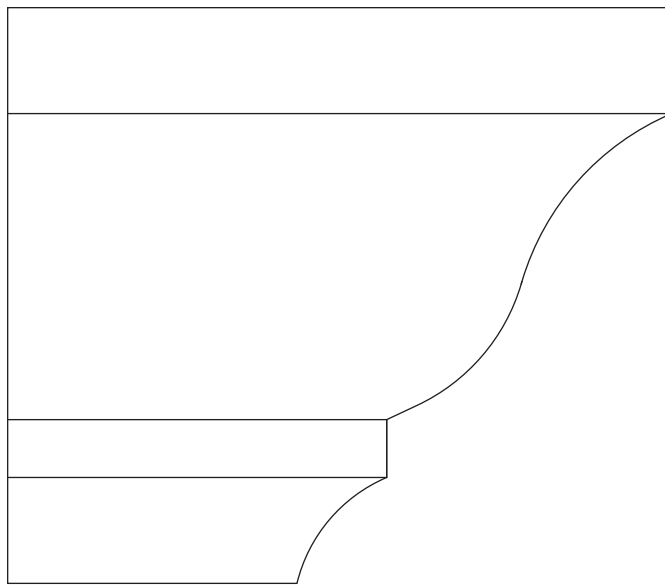

Walls & Ceilings

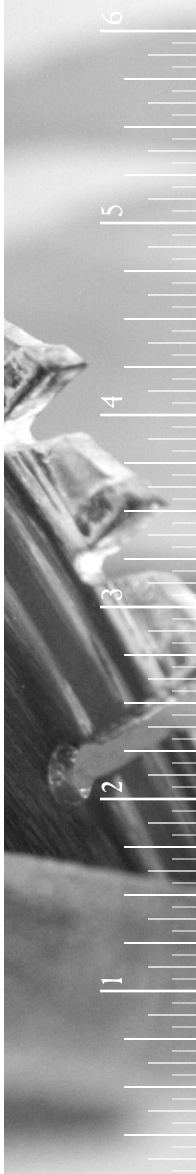

SCALE: Actual Size

CROWNS AND PICTURES

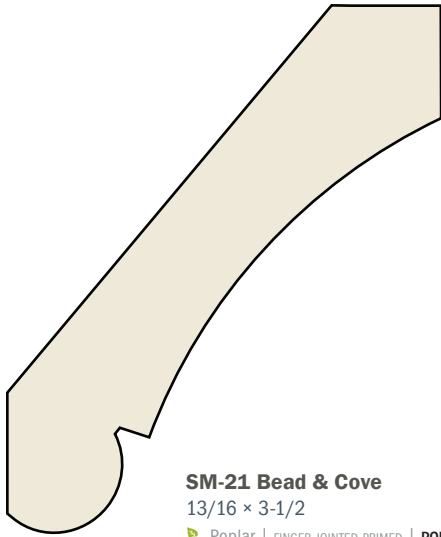

SM-21 Bead & Cove
13/16 × 3-1/2

Poplar | FINGER JOINTED PRIMED | POPCRSM21FPR

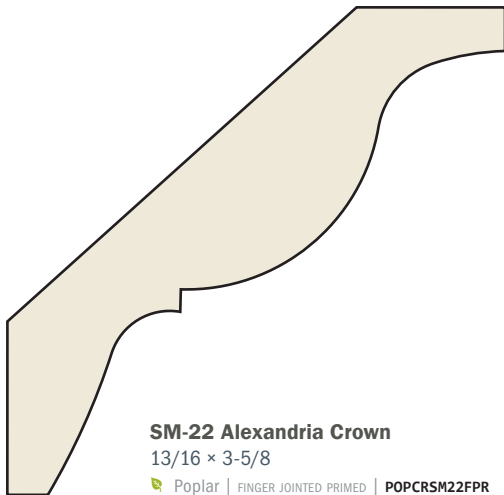
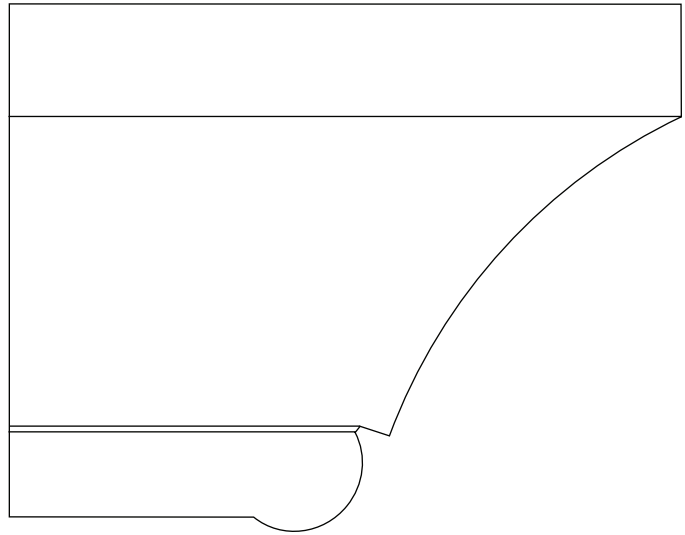

SM-22 Alexandria Crown
13/16 × 3-5/8

Poplar | FINGER JOINTED PRIMED | POPCRSM22FPR

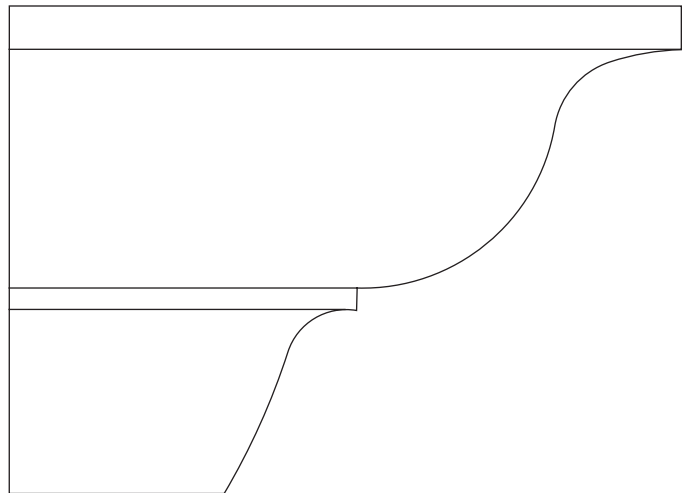

SCALE: Actual Size

CROWNS AND PICTURES

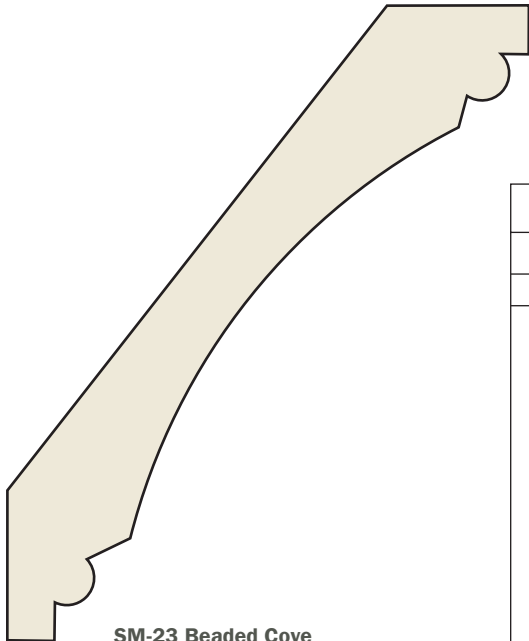

SM-23 Beaded Cove
13/16 × 4-1/4

Poplar | FINGER JOINTED PRIMED | POPCVM23FPR

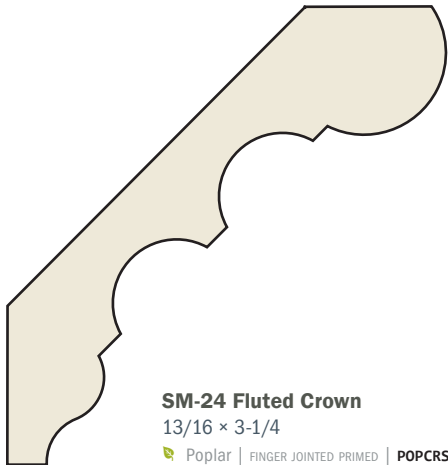
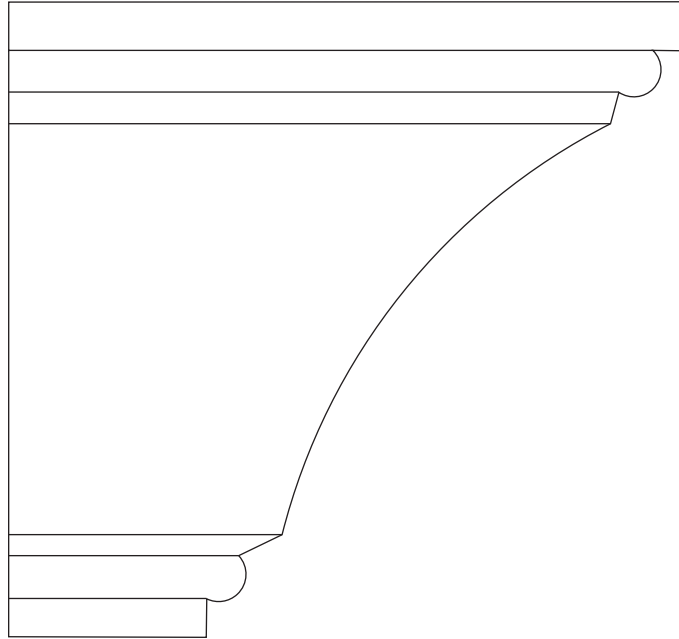

SM-24 Fluted Crown
13/16 × 3-1/4

Poplar | FINGER JOINTED PRIMED | POPCRSM24FPR

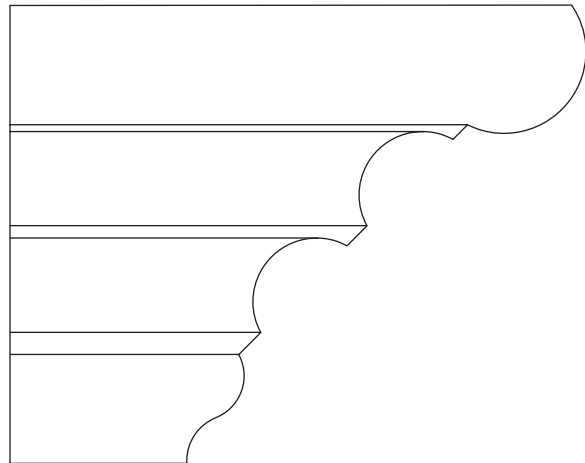

SCALE: Actual Size

CROWNS AND PICTURES

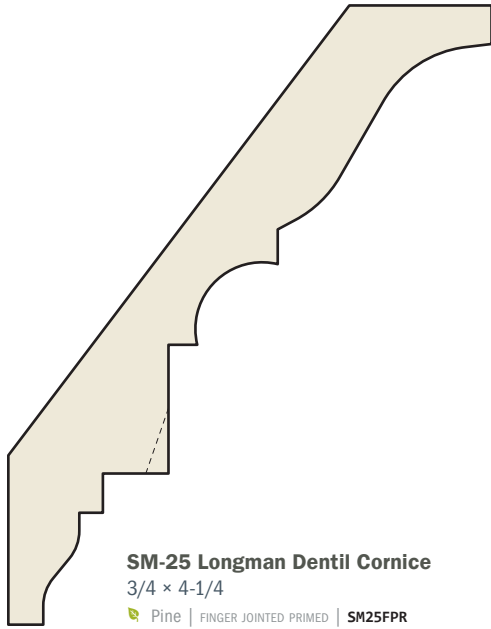

SM-25 Longman Dentil Cornice
3/4 x 4-1/4
Pine | FINGER JOINTED PRIMED | SM25FPR

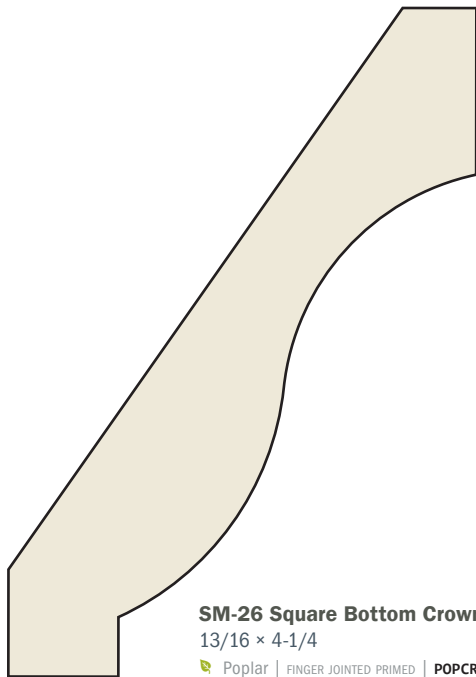
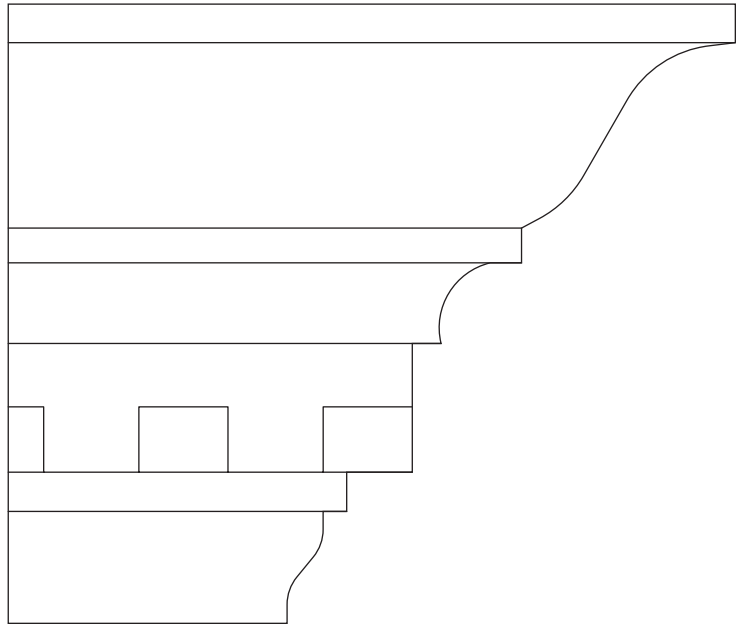

SM-26 Square Bottom Crown
13/16 x 4-1/4
Poplar | FINGER JOINTED PRIMED | POPCRSM26FPR

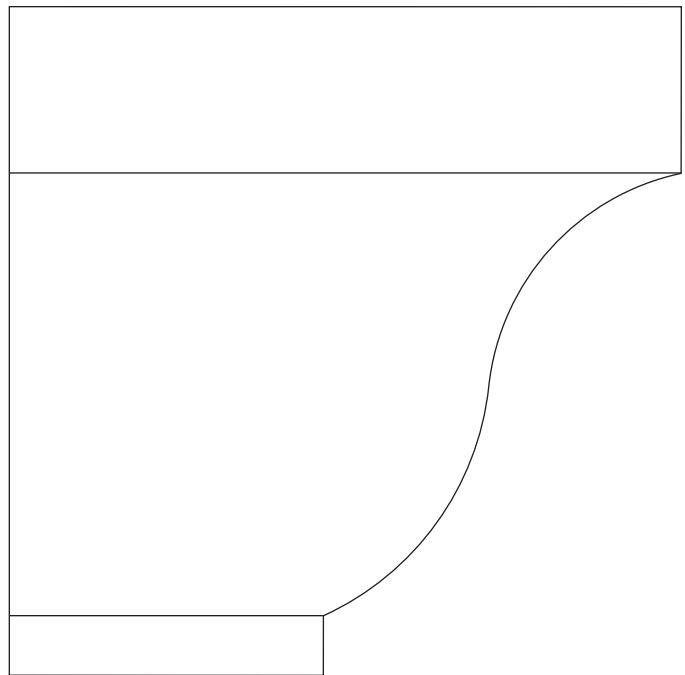



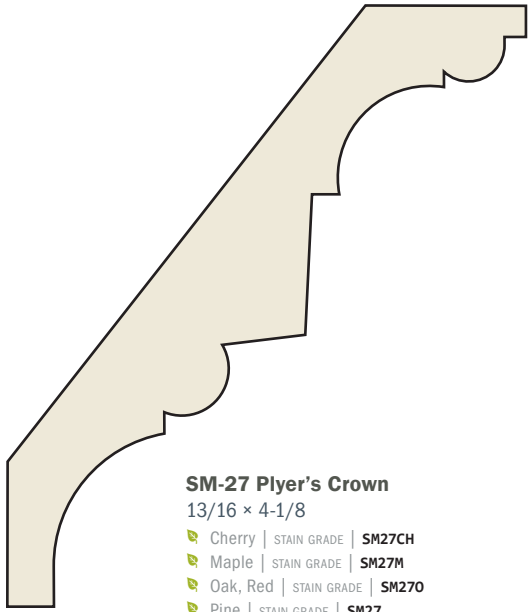

SCALE: Actual Size

CROWNS AND PICTURES

Walls & Ceilings



SM-27 Plyer's Crown
13/16 × 4-1/8

-  Cherry | STAIN GRADE | **SM27CH**
-  Maple | STAIN GRADE | **SM27M**
-  Oak, Red | STAIN GRADE | **SM27O**
-  Pine | STAIN GRADE | **SM27**
-  Poplar | FINGER JOINTED PRIMED | **POPCRSM27FPR**

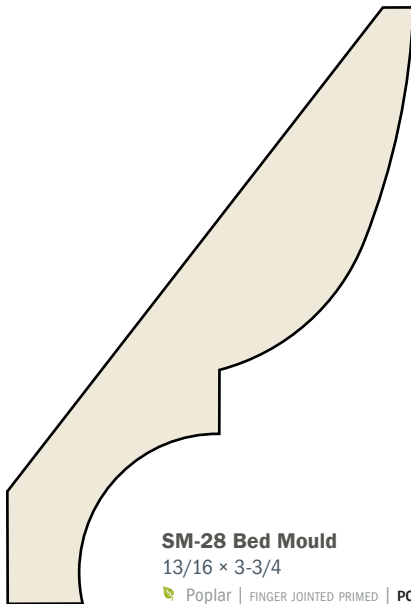
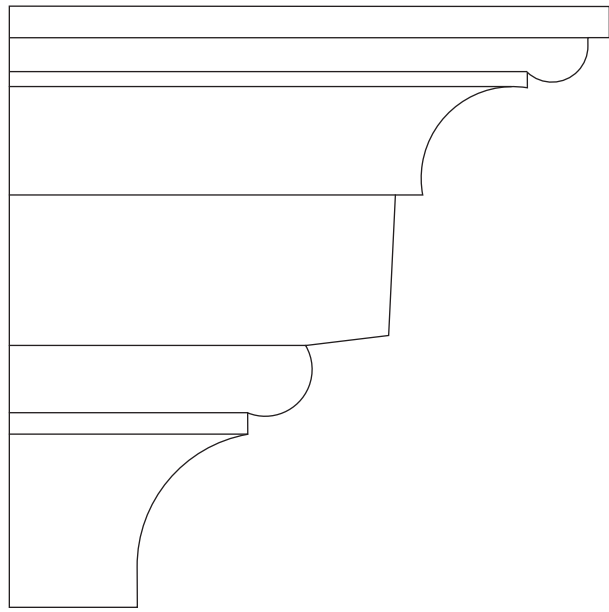

SM-28 Bed Mould
13/16 × 3-3/4

-  Poplar | FINGER JOINTED PRIMED | **POPCRSM28FPR**

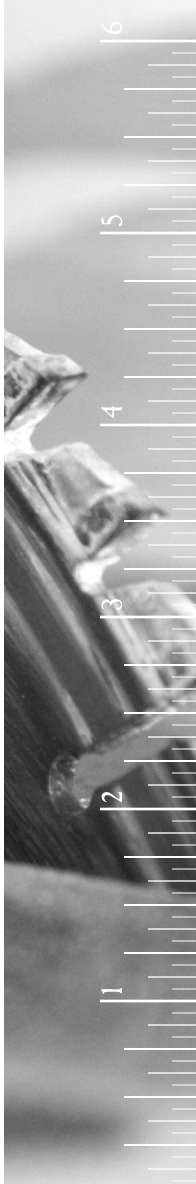
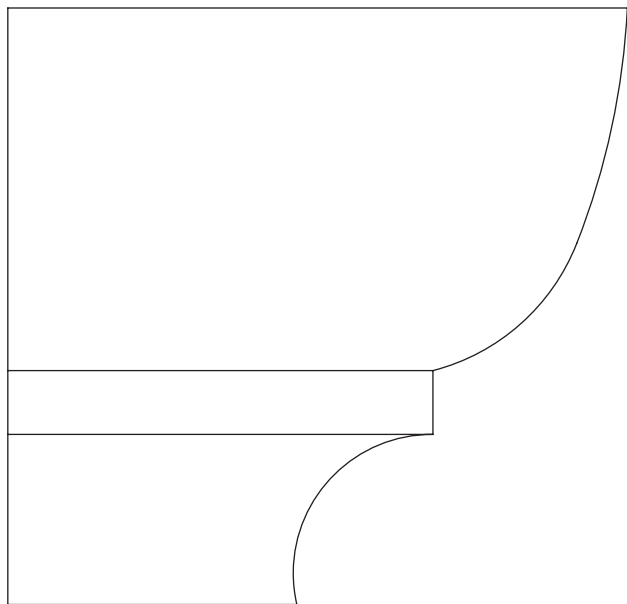

SCALE: Actual Size

CROWNS AND PICTURES

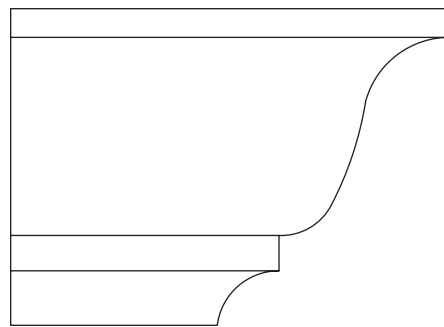
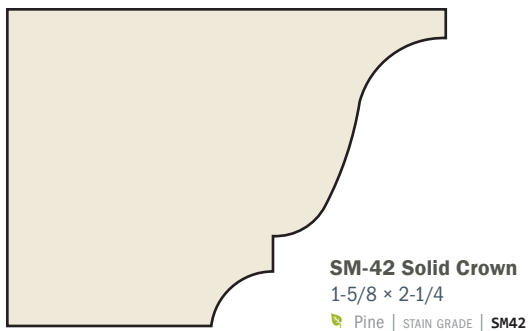
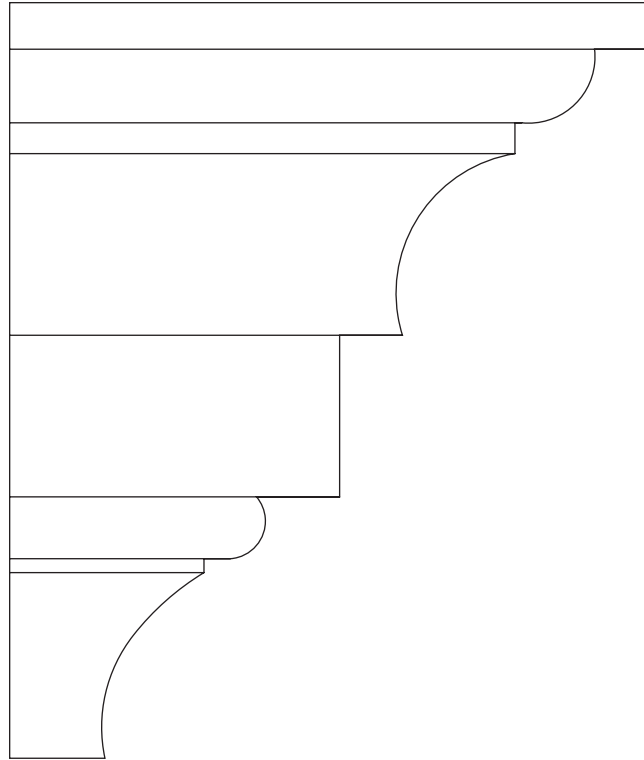
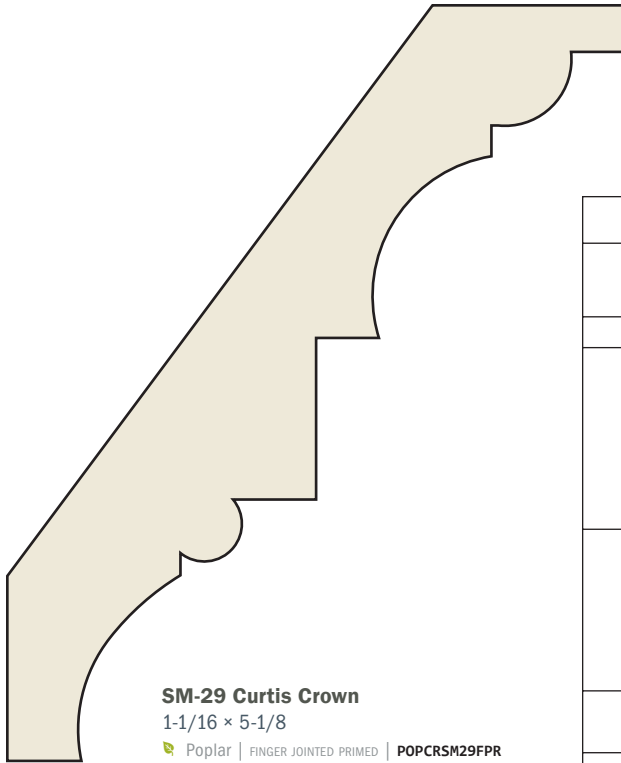

SCALE: Actual Size

CROWNS AND PICTURES



SM-32 Gilbert's Crown
3/4 x 5-1/4
Poplar | FINGER JOINTED PRIMED | POPCRSM32FPR

Walls & Ceilings

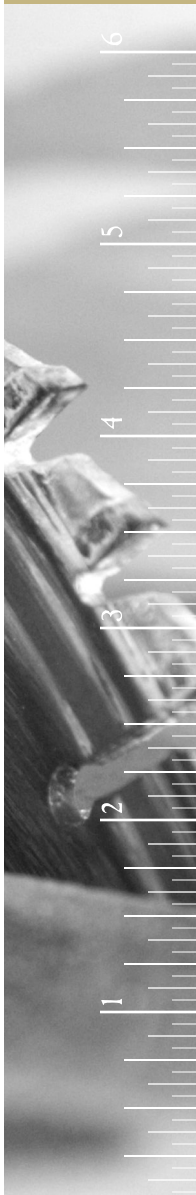

SCALE: Actual Size

CROWNS AND PICTURES

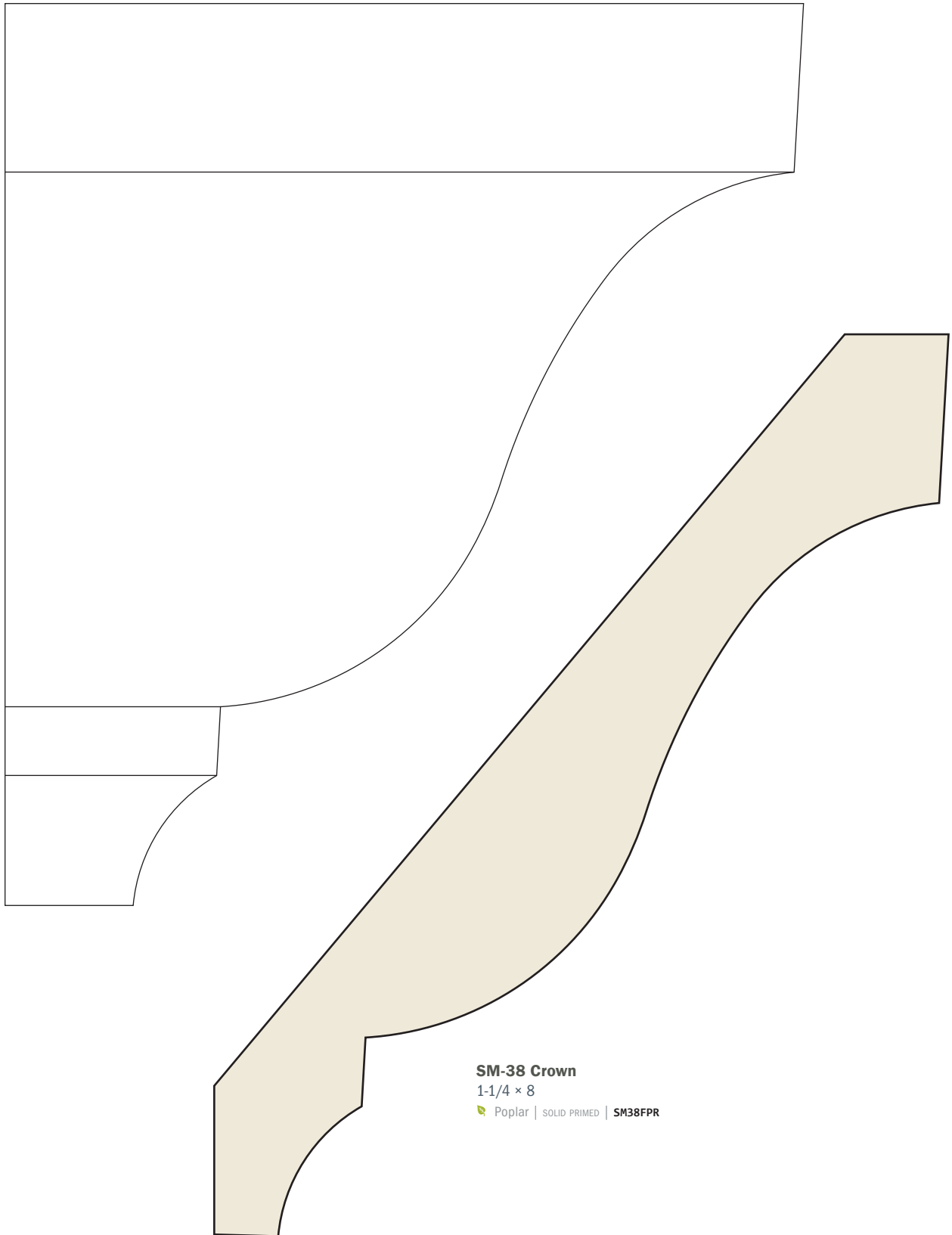

SM-38 Crown
1-1/4 × 8

Poplar | SOLID PRIMED | SM38FPR

SCALE: Actual Size

CROWNS AND PICTURES

Walls & Ceilings

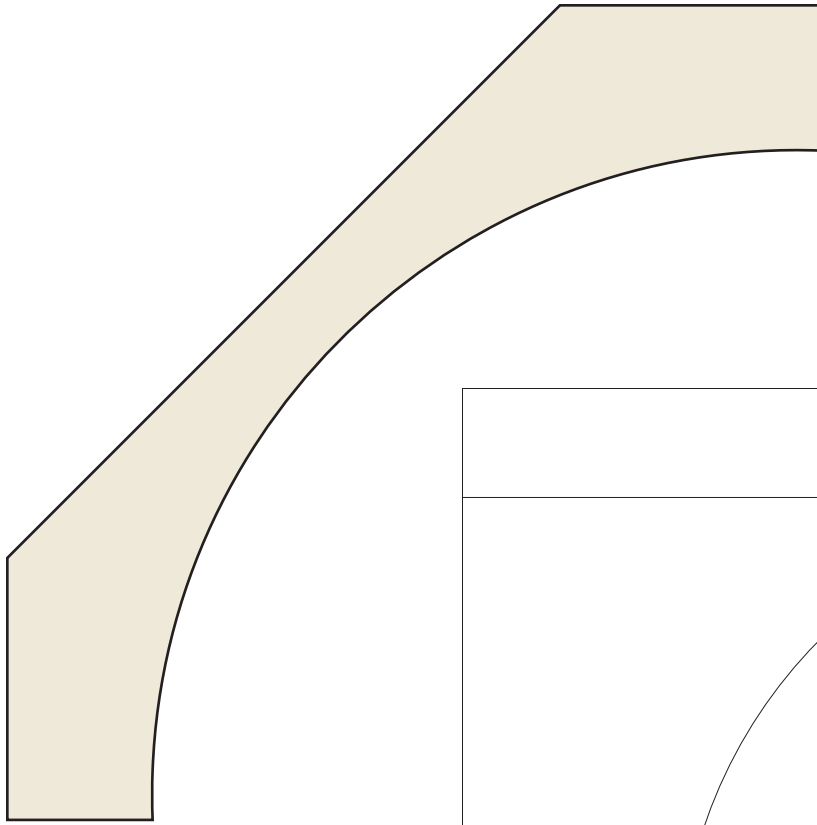

SM-86 Cove
1-1/2 x 6
Poplar | SOLID PRIMED | POPVSM86PR

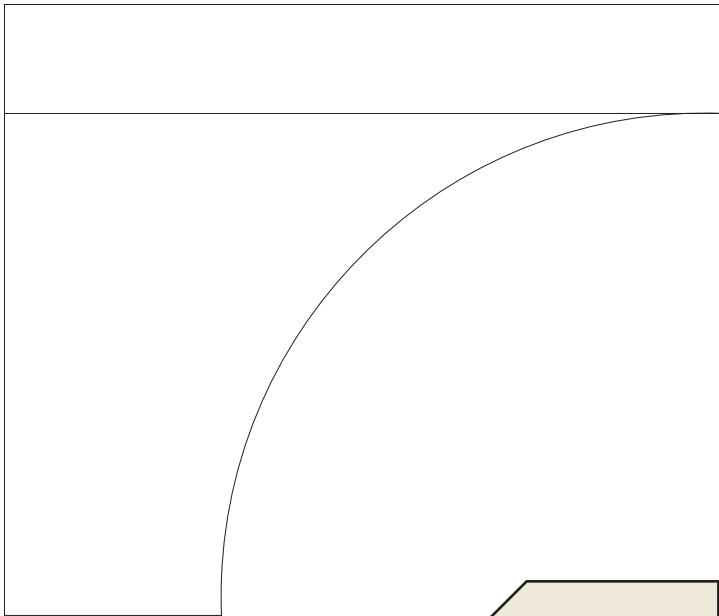

SM-81 Cove
1-1/16 x 4-5/8
Pine | FINGER JOINTED PRIMED | WM81P

SCALE: Actual Size

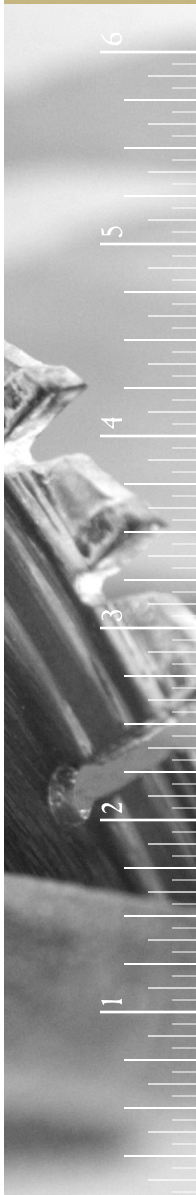

CROWNS AND PICTURES



SM-125 Longman Plain Crown
13/16 × 4-1/4

Poplar | FINGER JOINTED PRIMED | POPCRSM125FPR

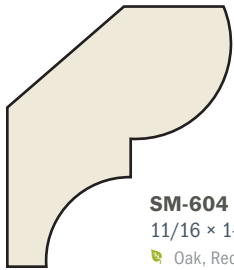
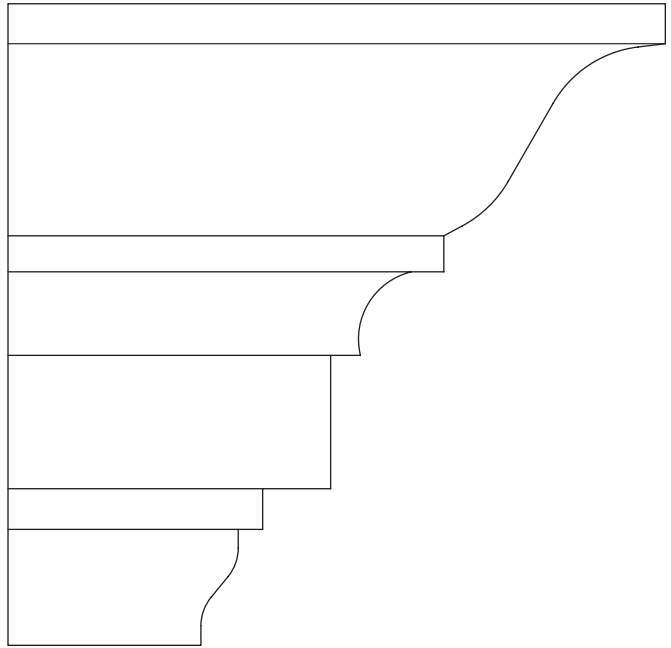

SM-604 Bed Mould
11/16 × 1-3/4

Oak, Red | STAIN GRADE | SM6040

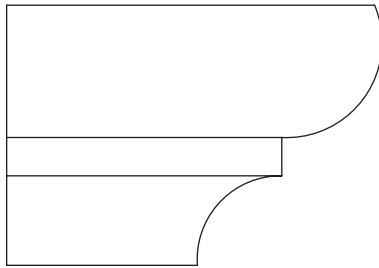

SCALE: Actual Size

CROWNS AND PICTURES

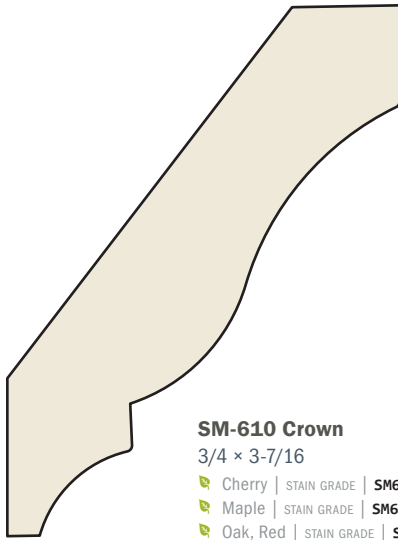

SM-610 Crown

3/4 x 3-7/16

- Cherry | STAIN GRADE | SM610CH
- Maple | STAIN GRADE | SM610M
- Oak, Red | STAIN GRADE | SM610O

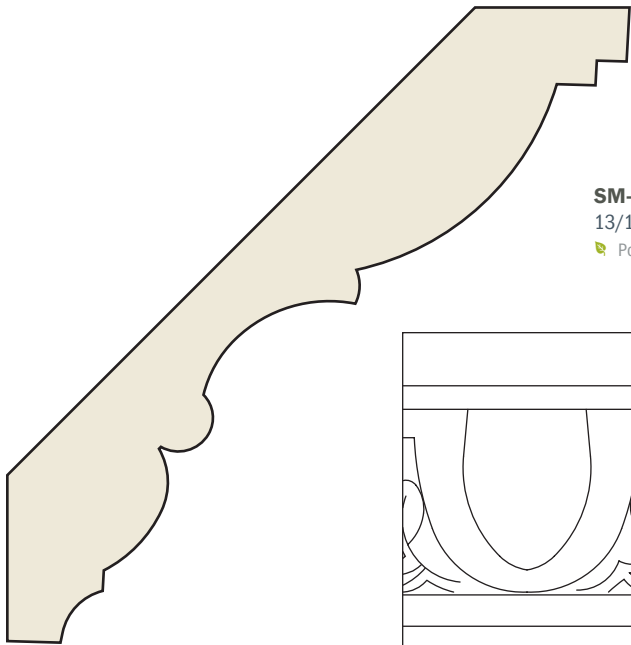
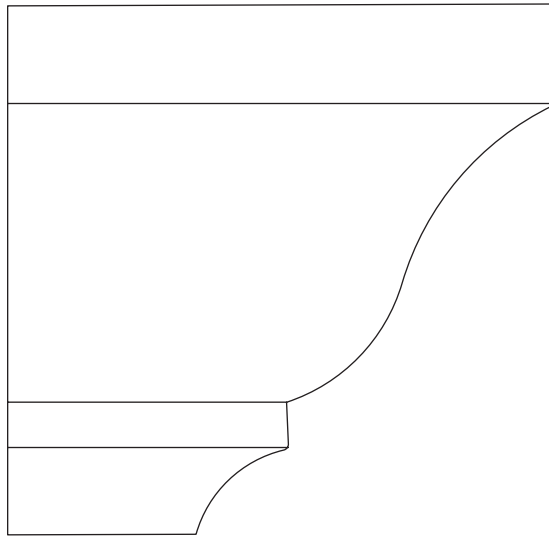

SM-687 Embossed Crown

13/16 x 4-5/8

- Poplar | SOLID PRIMED | POPCRSM687FPR

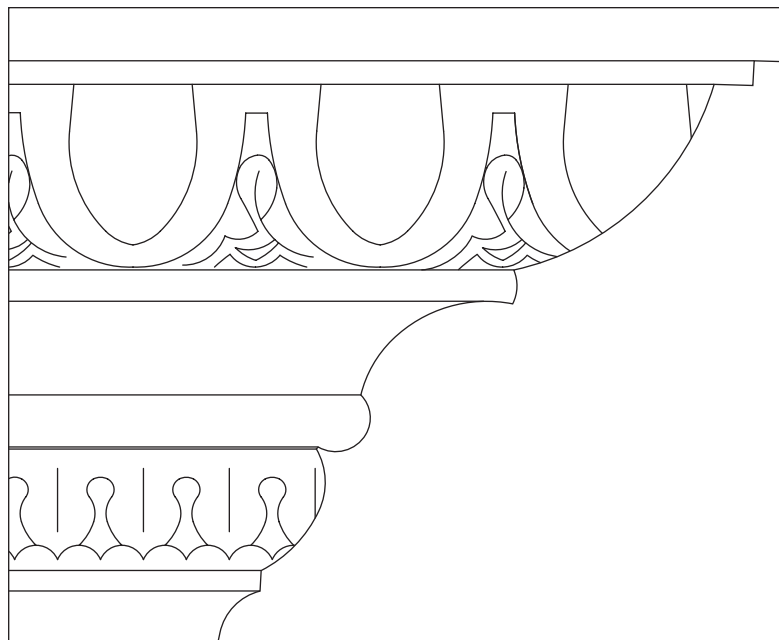

SCALE: Actual Size

Walls & Ceilings

CROWNS AND PICTURES

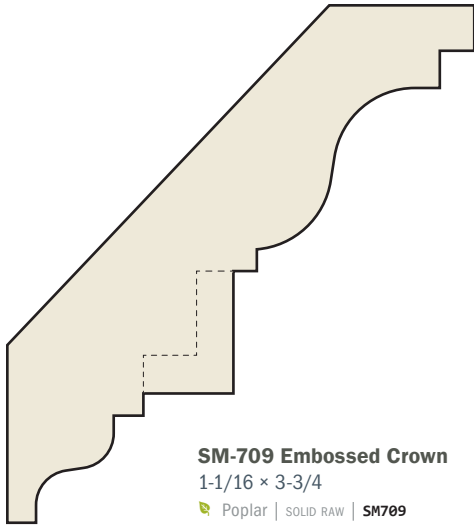

SM-709 Embossed Crown
1-1/16 × 3-3/4
Poplar | SOLID RAW | SM709

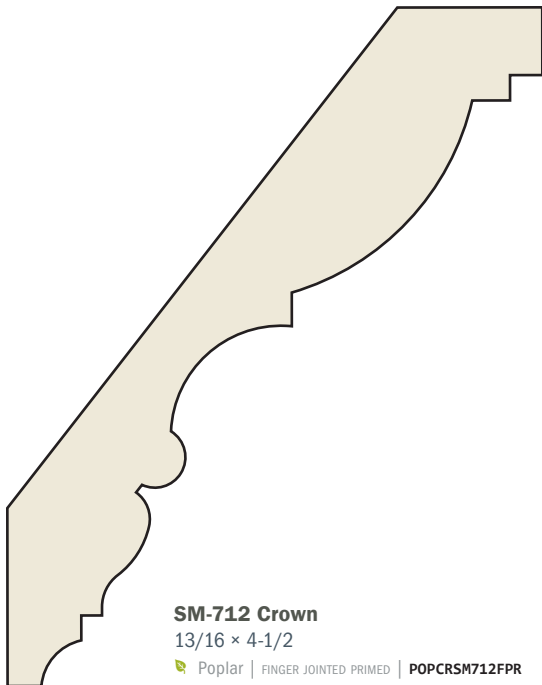
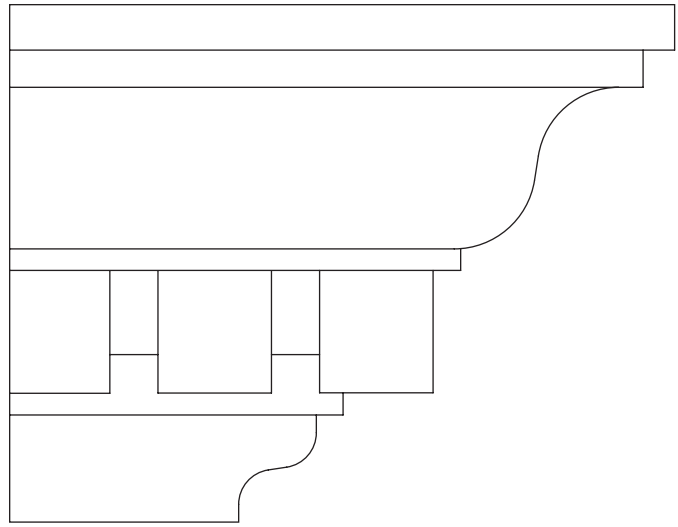

SM-712 Crown
13/16 × 4-1/2
Poplar | FINGER JOINTED PRIMED | POPCRSM712FPR

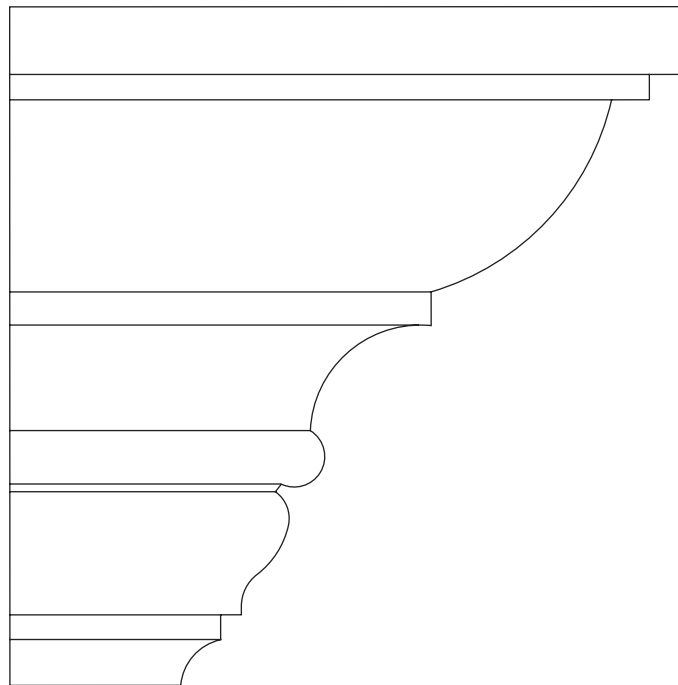

SCALE: Actual Size

CROWNS AND PICTURES

Walls & Ceilings

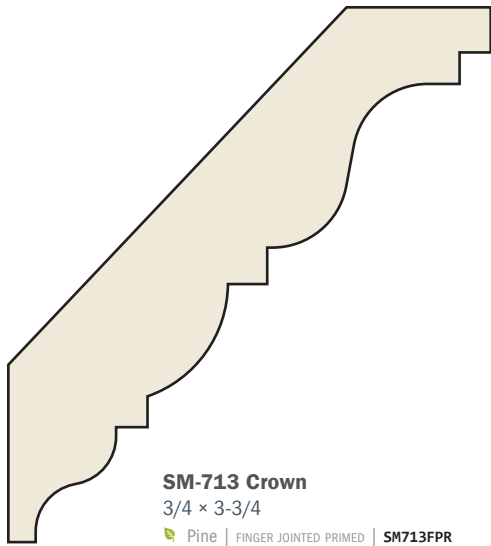

SM-713 Crown
3/4 × 3-3/4

🌲 Pine | FINGER JOINTED PRIMED | SM713FPR

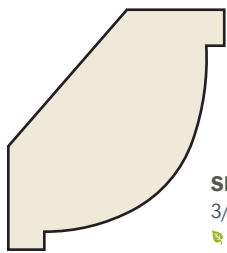
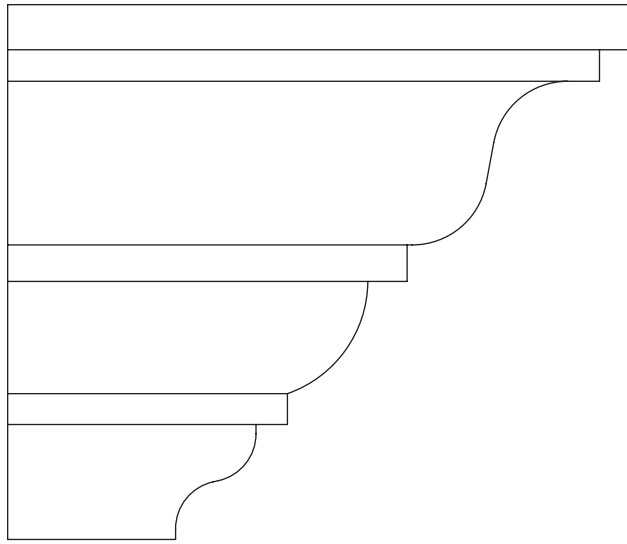

SM-870 Tavern Crown
3/4 × 1-11/16

🌲 Poplar | SOLID PRIMED | POPCREVSM870PR

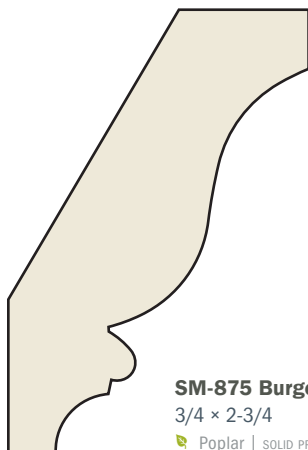
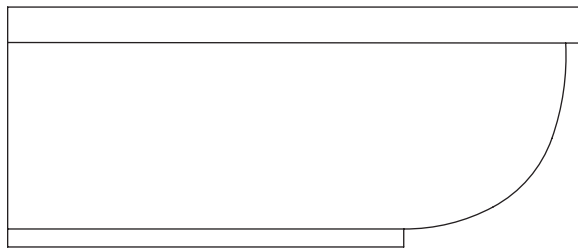

SM-875 Burgess Crown
3/4 × 2-3/4

🌲 Poplar | SOLID PRIMED | POPCREVSM875PR

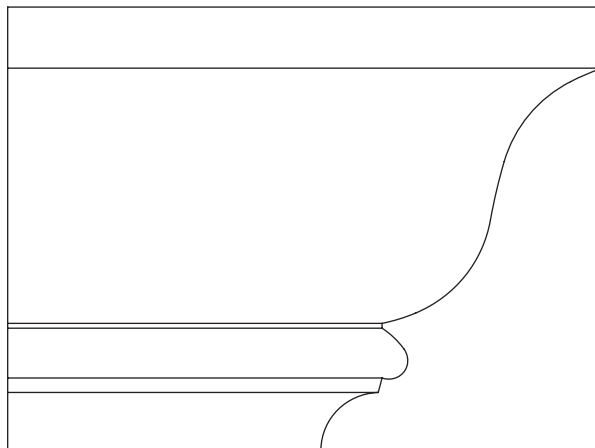

📏 SCALE: Actual Size

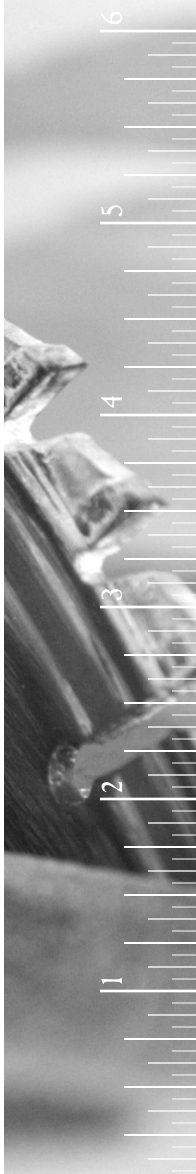

CROWNS AND PICTURES

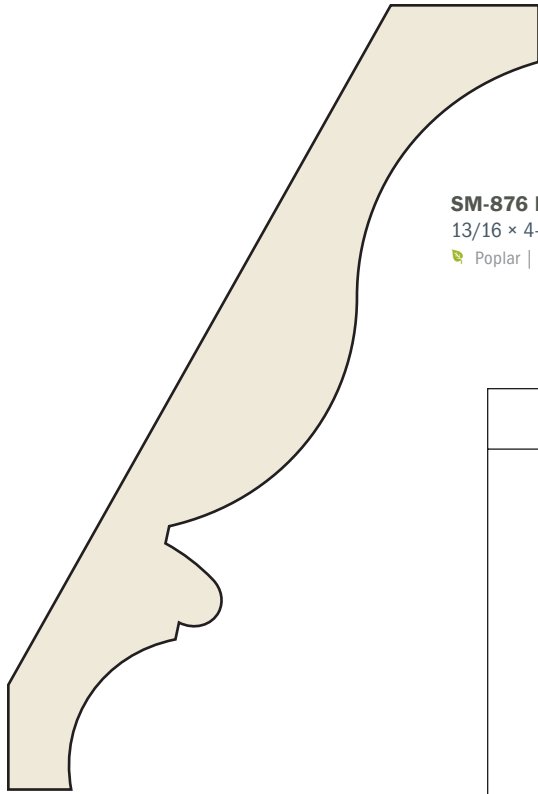

SM-876 Burgess Crown

13/16 × 4-7/8

Poplar | SOLID PRIMED | POPCREVSM876PR

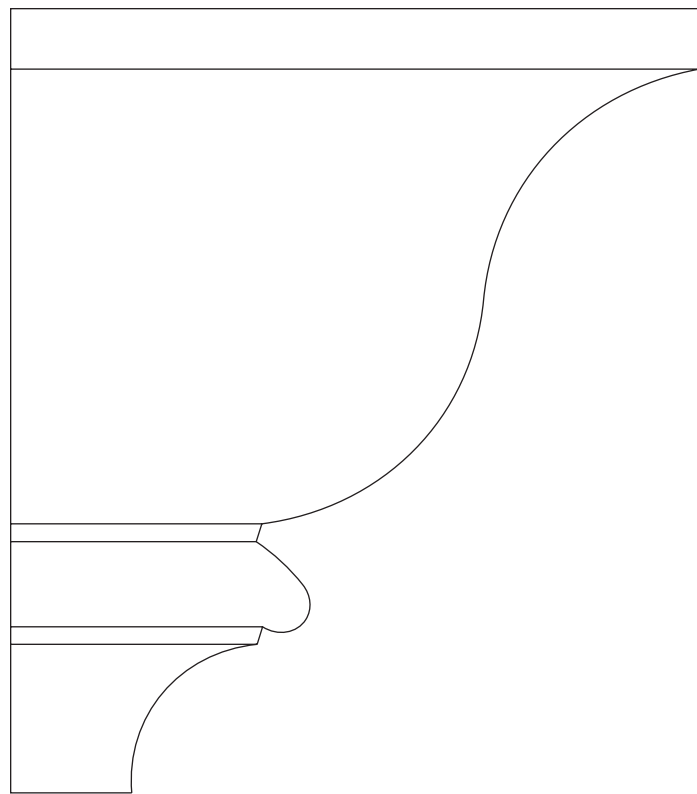

SCALE: Actual Size

CROWNS AND PICTURES

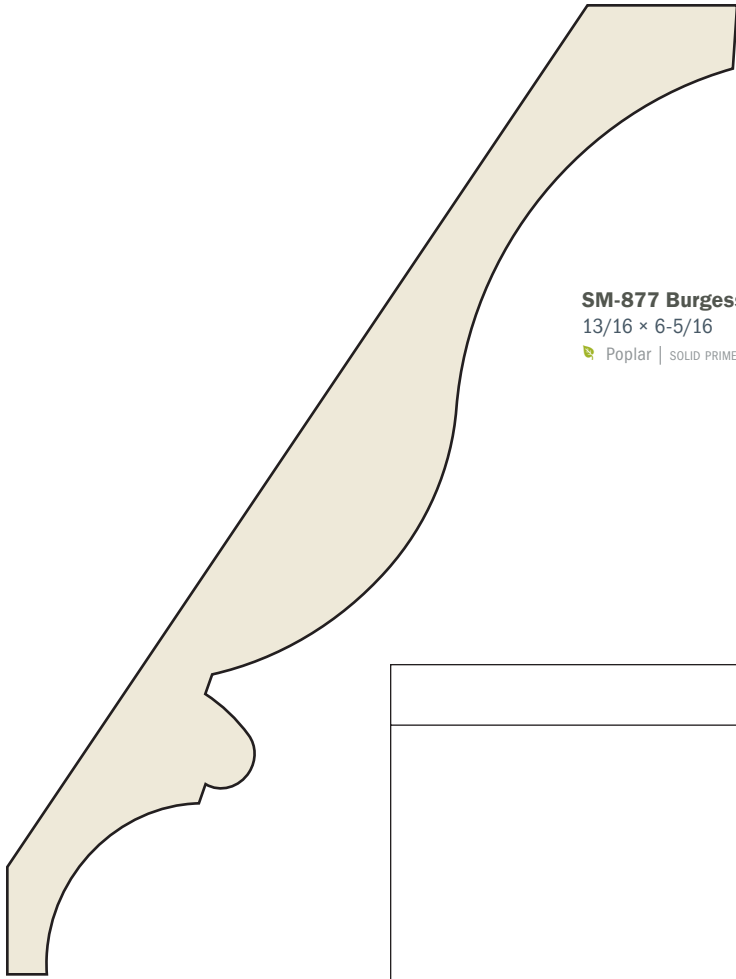

SM-877 Burgess Crown

13/16 × 6-5/16

Poplar | SOLID PRIMED | POPCREVSM877PR

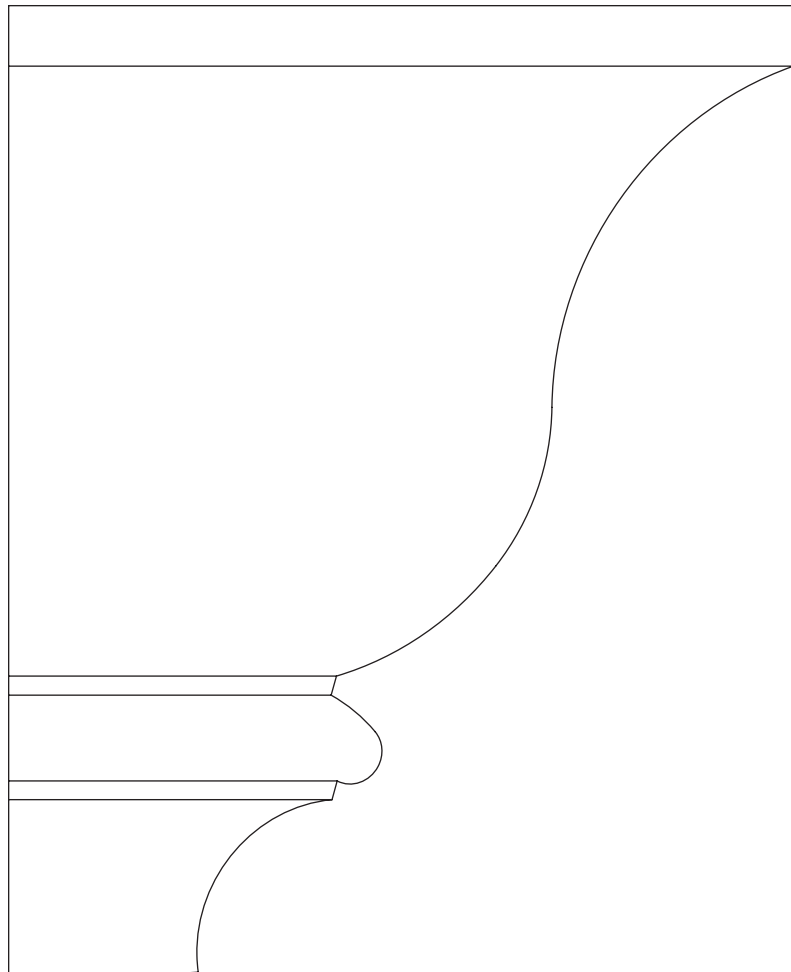

SCALE: Actual Size

Walls & Ceilings

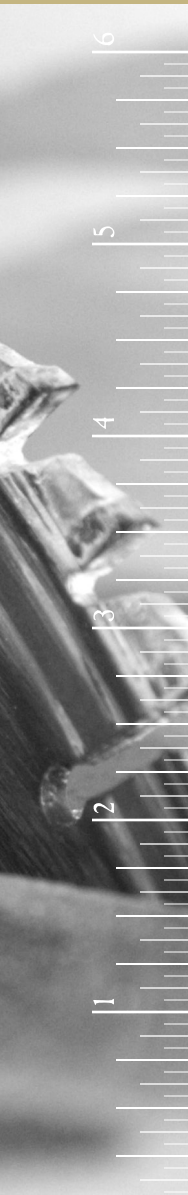

CROWNS AND PICTURES

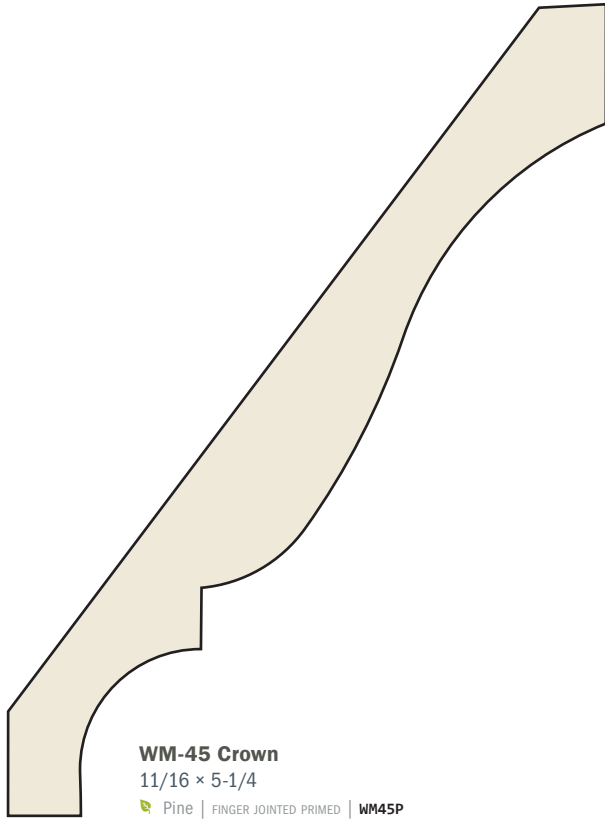

WM-45 Crown
11/16 × 5-1/4
Pine | FINGER JOINTED PRIMED | WM45P

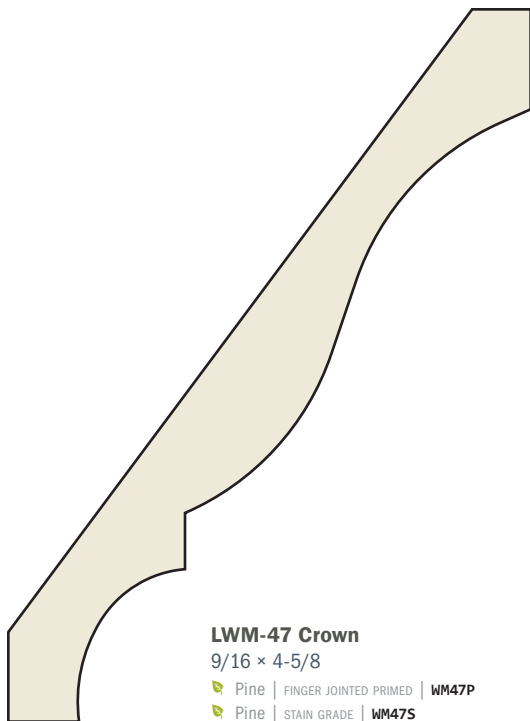
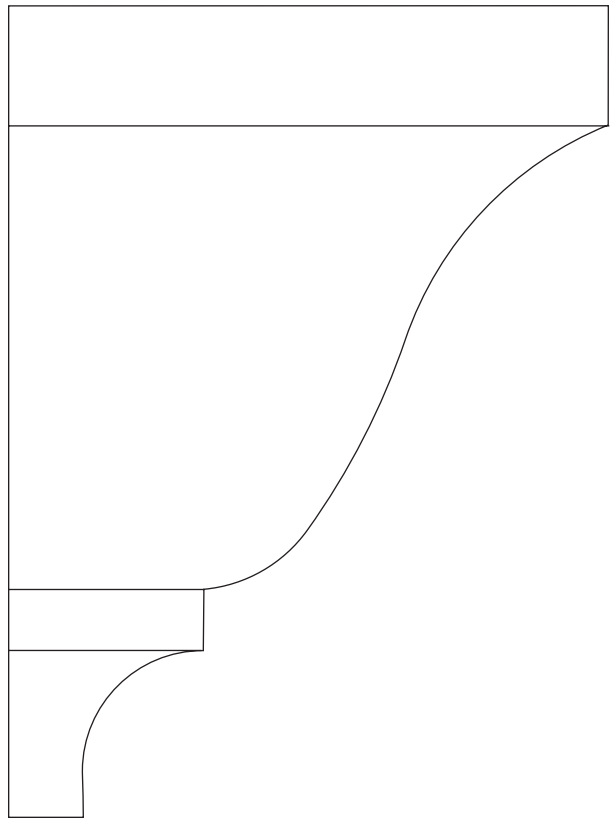

LWM-47 Crown
9/16 × 4-5/8
Pine | FINGER JOINTED PRIMED | WM47P
Pine | STAIN GRADE | WM47S

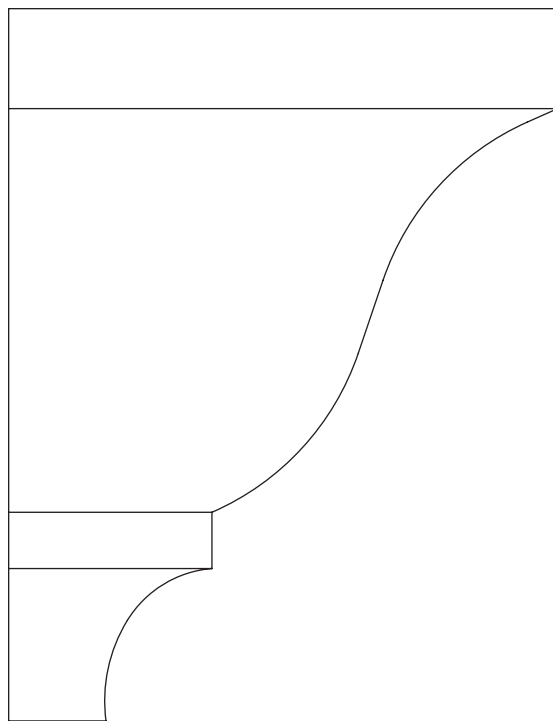

SCALE: Actual Size

CROWNS AND PICTURES

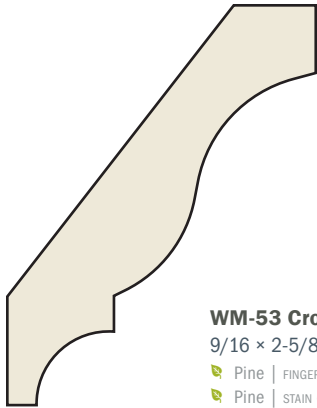

WM-53 Crown

9/16 × 2-5/8

 Pine | FINGER JOINTED PRIMED | WM53P
 Pine | STAIN GRADE | WM53S

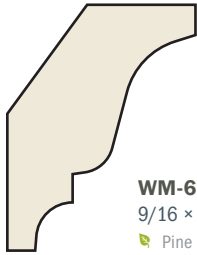
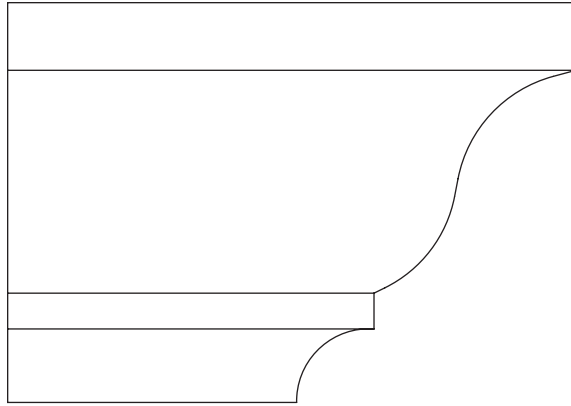

WM-68 Crown

9/16 × 1-5/8

 Pine | STAIN GRADE | WM68S

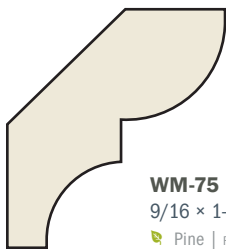
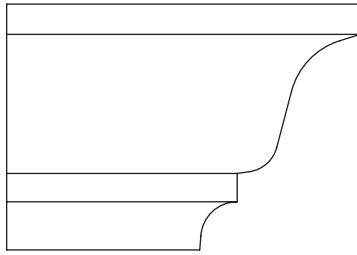

WM-75 Bed Mould

9/16 × 1-5/8

 Pine | FINGER JOINTED PRIMED | WM75P

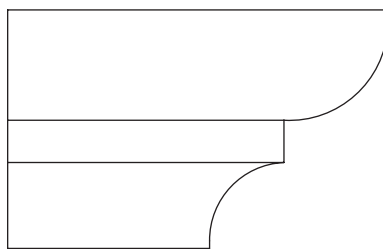

Walls & Ceilings

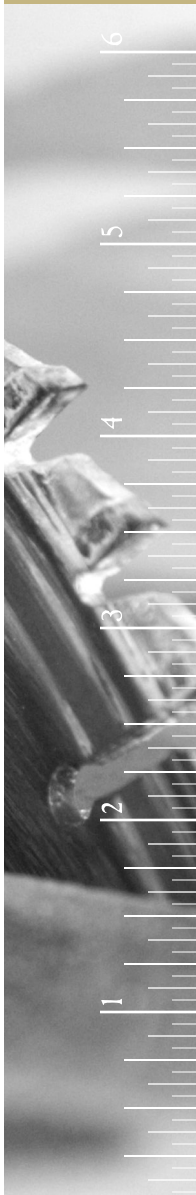

 SCALE: Actual Size

CROWNS AND PICTURES

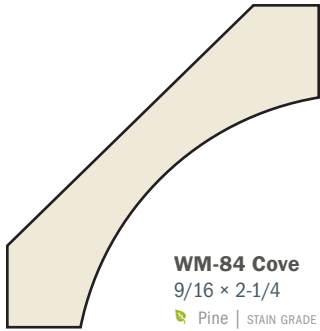

WM-84 Cove
9/16 × 2-1/4
Pine | STAIN GRADE | WM84S

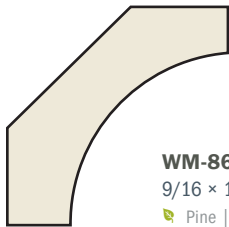
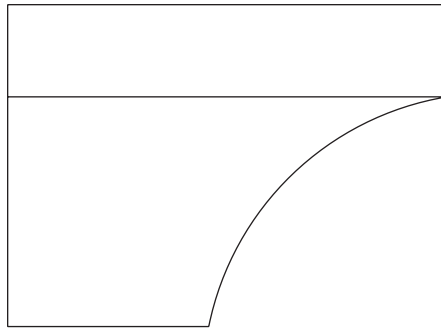

WM-86 Cove
9/16 × 1-5/8
Pine | STAIN GRADE | WM86S

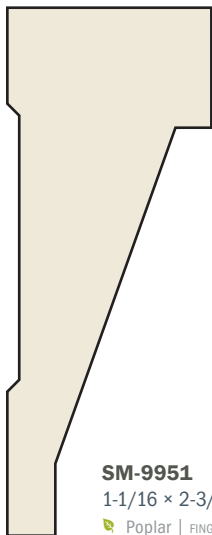
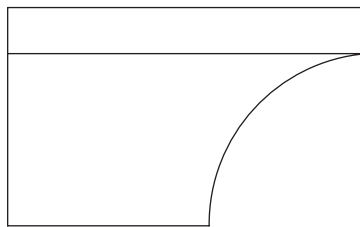

SM-9951
1-1/16 × 2-3/4
Poplar | FINGER JOINTED PRIMED | POPCRSM9951FPR

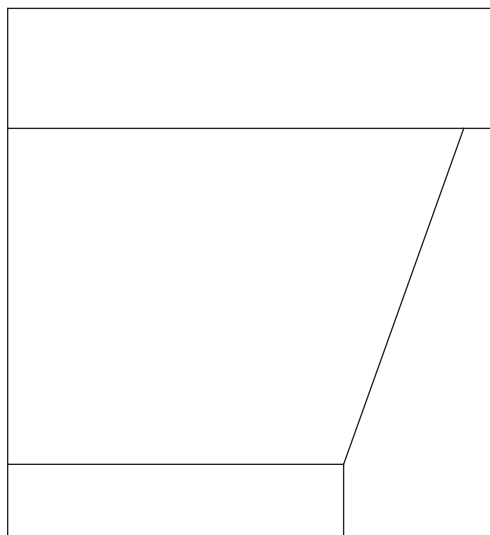

SCALE: Actual Size

CROWNS AND PICTURES

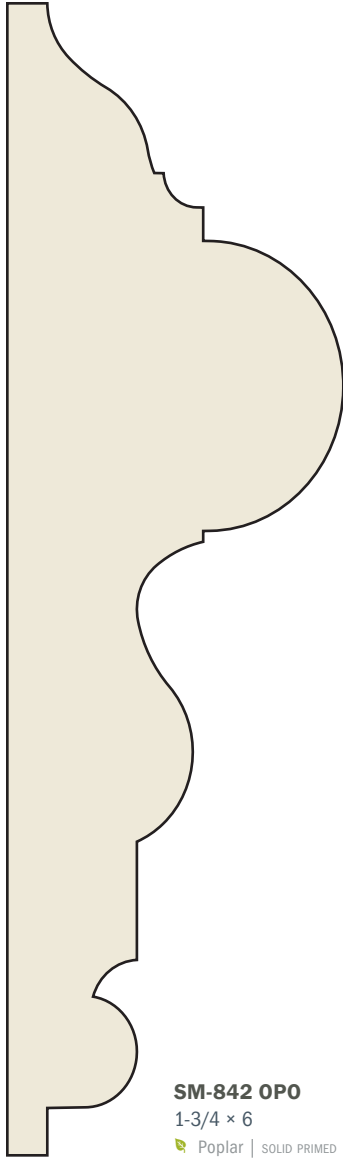

SM-842 OPO
1-3/4 x 6
Poplar | SOLID PRIMED | POPCHEVSM842PR

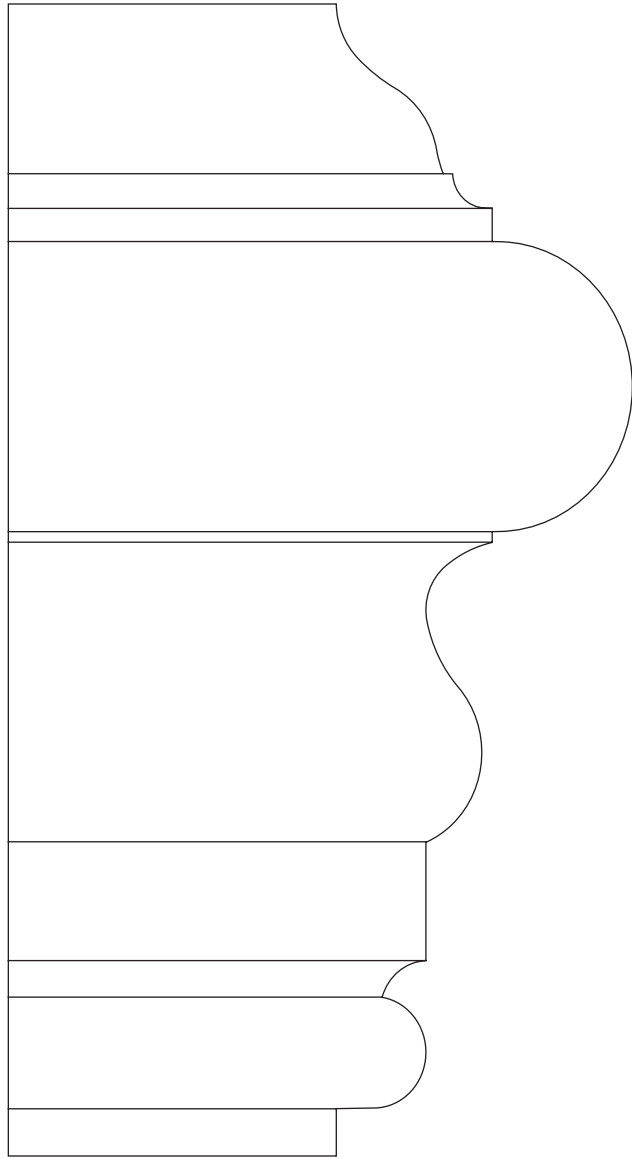

Walls & Ceilings

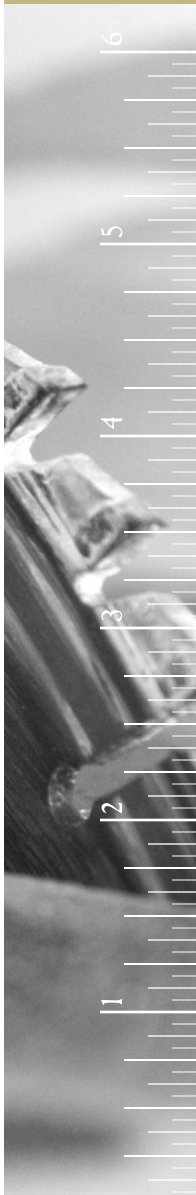

SCALE: Actual Size

CROWNS AND PICTURES

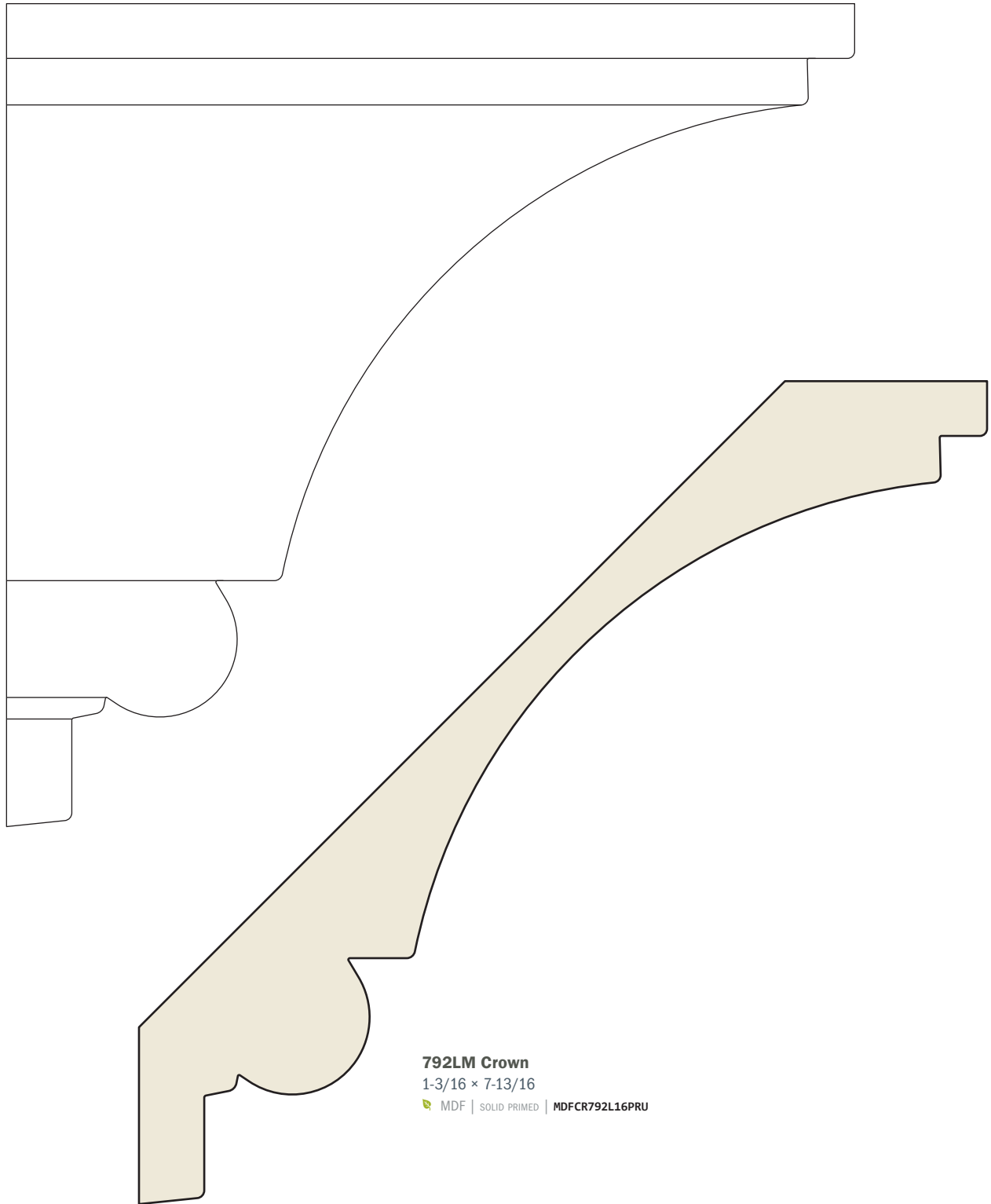

792LM Crown
1-3/16 × 7-13/16

MDF | SOLID PRIMED | MDFCR792L16PRU

SCALE: Actual Size

CROWNS AND PICTURES

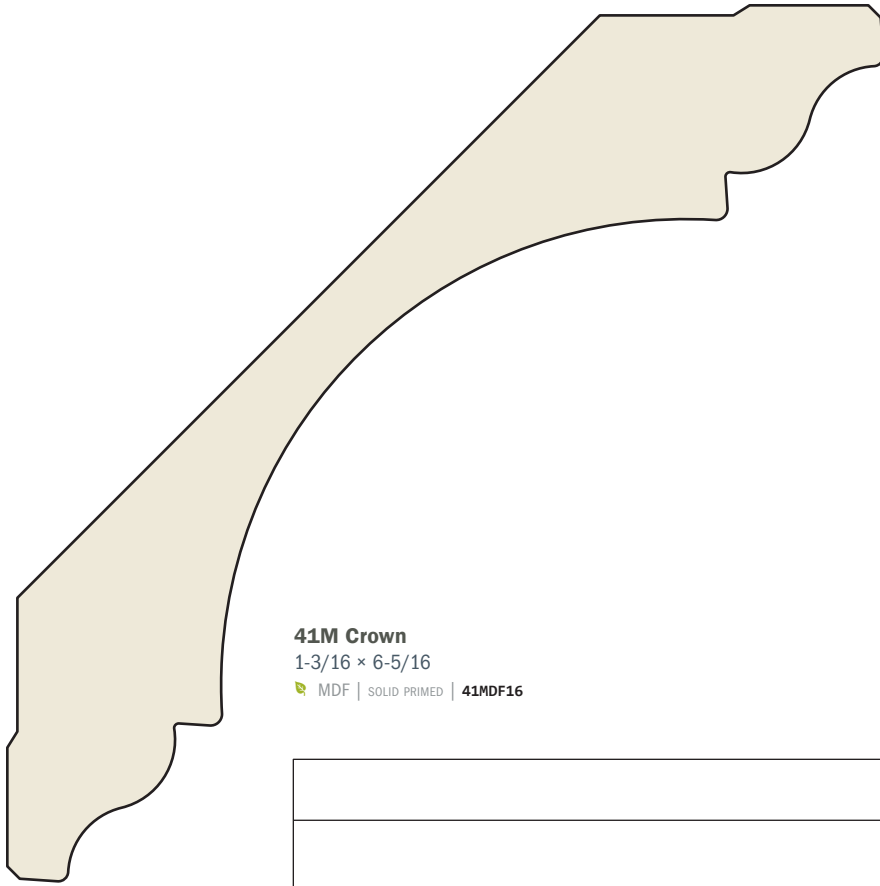

41M Crown
1-3/16 × 6-5/16
MDF | SOLID PRIMED | 41MDF16

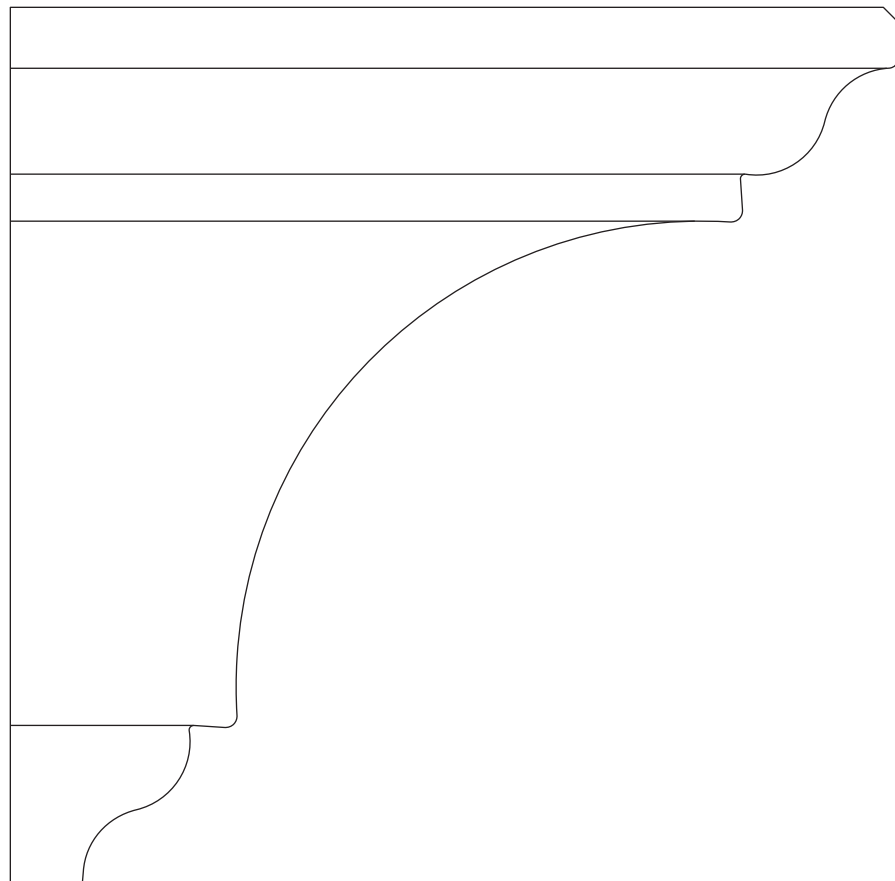

SCALE: Actual Size

Walls & Ceilings

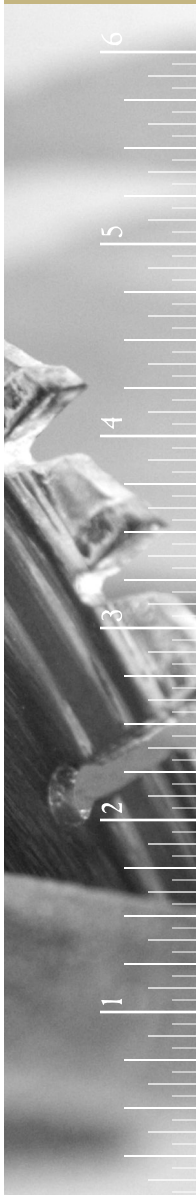

CROWNS AND PICTURES

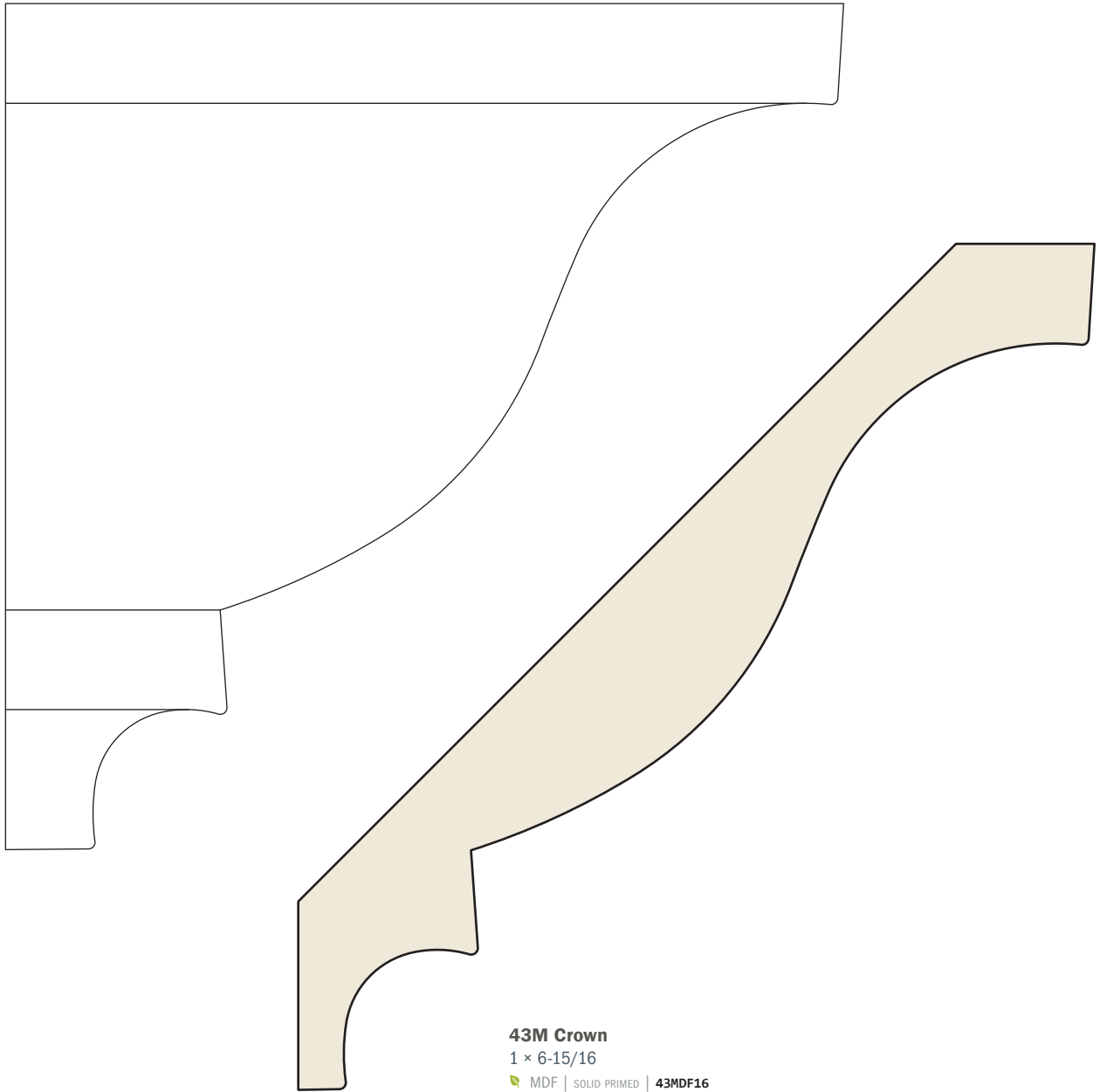

43M Crown
1 × 6-15/16

MDF | SOLID PRIMED | 43MDF16

SCALE: Actual Size

CROWNS AND PICTURES

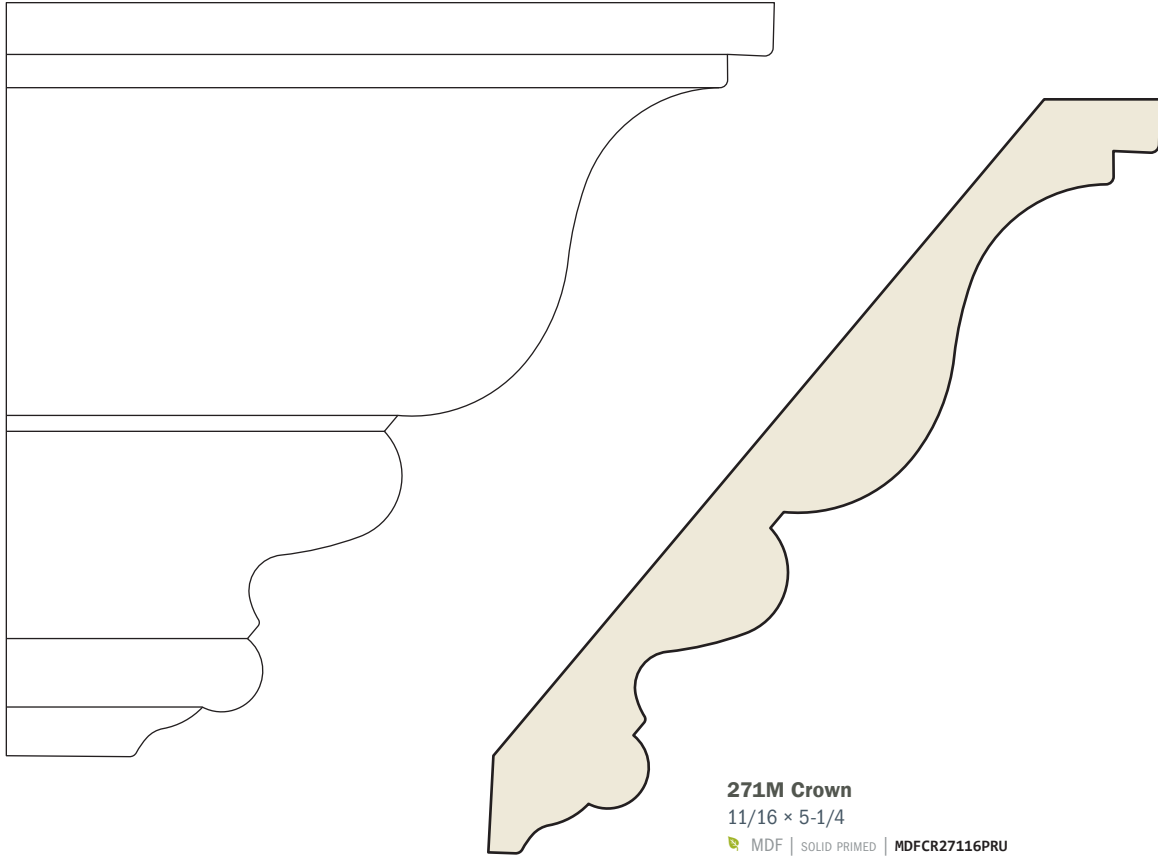

271M Crown
11/16 × 5-1/4

MDF | SOLID PRIMED | MDFCR27116PRU

Walls & Ceilings

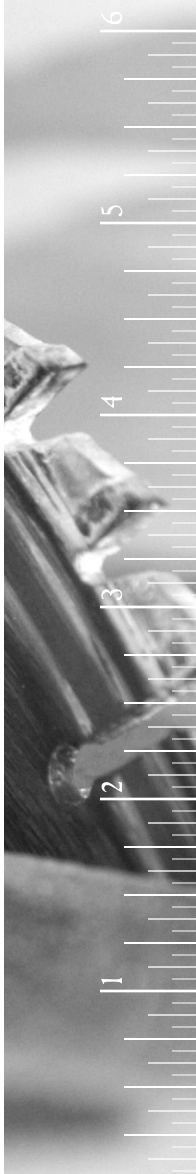

SCALE: Actual Size

CROWNS AND PICTURES

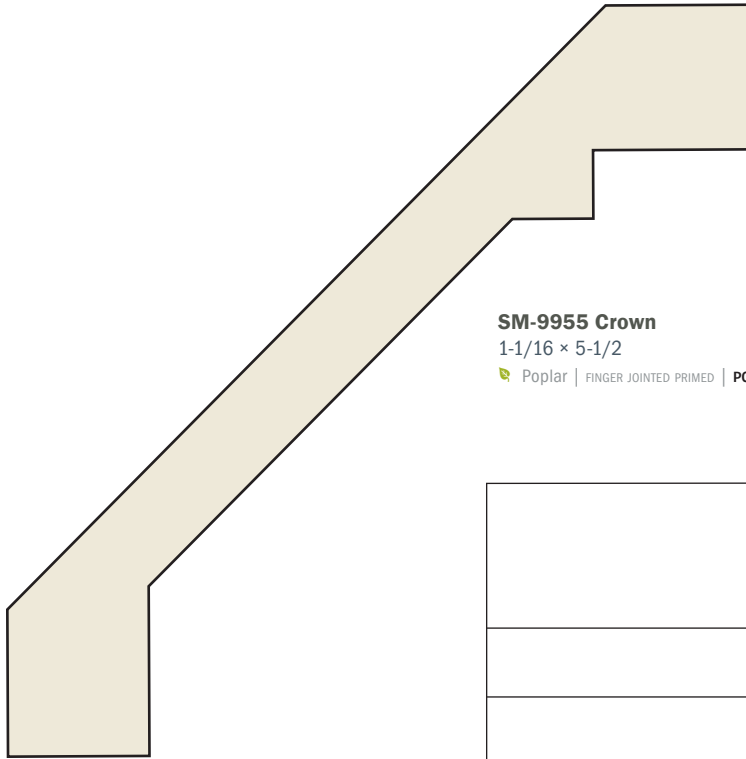

SM-9955 Crown
1-1/16 × 5-1/2

Poplar | FINGER JOINTED PRIMED | POPCRSM9955FPR

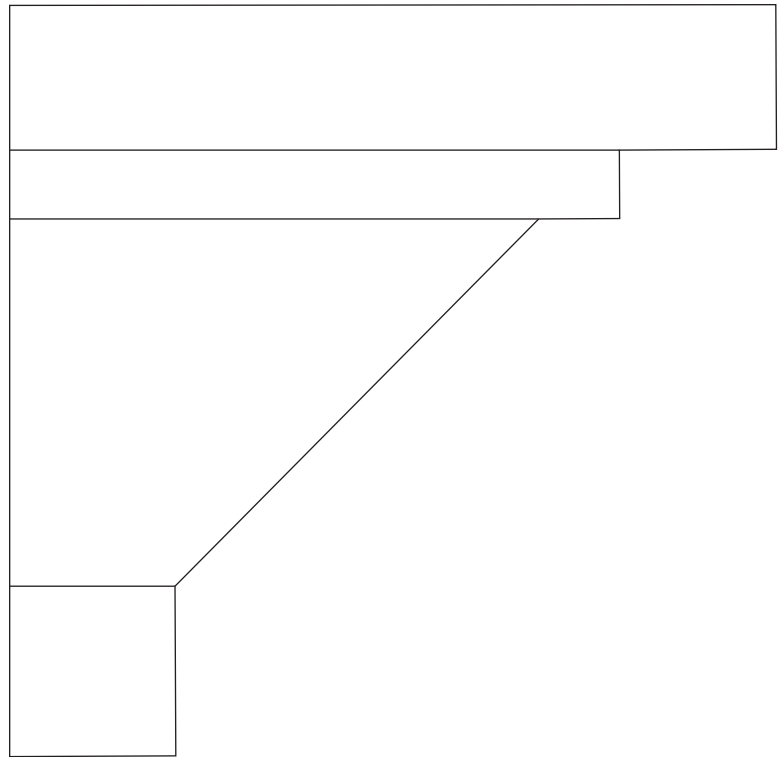

SCALE: Actual Size

CROWNS AND PICTURES

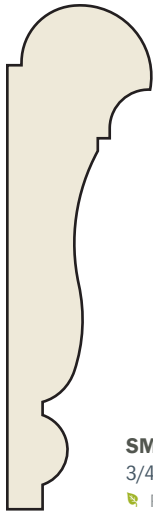

SM-846 Colonial Picture Mould
 3/4 x 2-5/8
 Poplar | SOLID PRIMED | POPPMEVSM846PR

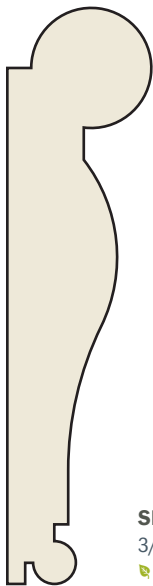
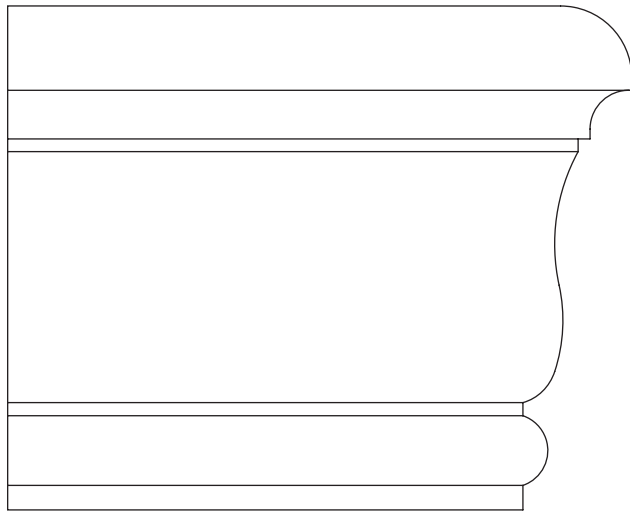

SM-847 Old Town Picture Mould
 3/4 x 3
 Poplar | SOLID PRIMED | POPPMEVSM847PR

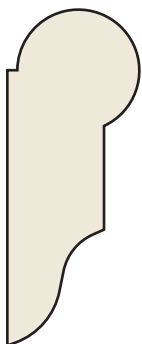
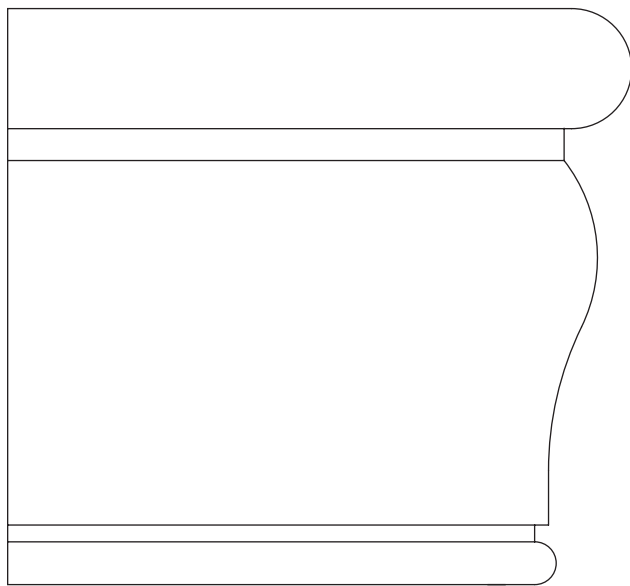

WM-276 Picture Mould
 11/16 x 1-3/4
 Pine | STAIN GRADE | WM276S

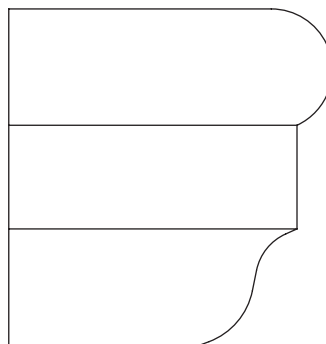

Walls & Ceilings

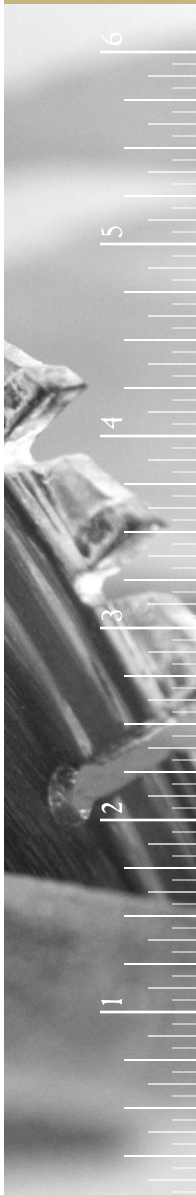

SCALE: Actual Size

CROWN BACKERS

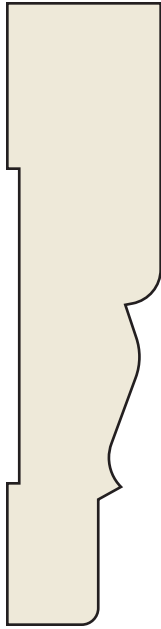

SM-1 Flatback Casing

13/16 × 3-1/4

🌲 Poplar | FINGER JOINTED PRIMED | **POPCSM1FPR**



WM-623 Ogee Base

9/16 × 3-1/4

🌲 Flex | **623FT12**
 🌲 Pine | FINGER JOINTED PRIMED | **WM623FP**
 🌲 Pine | STAIN GRADE | **WM623S**



WM-663 Ogee Base

9/16 × 3-1/4

🌲 Pine | FINGER JOINTED PRIMED | **WM663P**



WM-713 Ranch Base

9/16 × 3-1/4

🌲 Pine | FINGER JOINTED PRIMED | **WM713P**
 🌲 Pine | STAIN GRADE | **WM713S**



WM-753 Beaded Base

9/16 × 3-1/4

🌲 Pine | FINGER JOINTED PRIMED | **WM753P**
 🌲 Pine | STAIN GRADE | **WM753S**

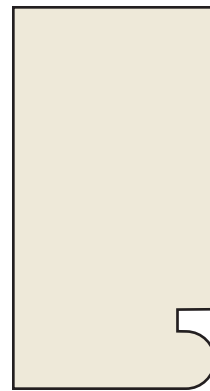

WM-175 Bullnose Brickmould

1-1/16 × 2



🌲 Pine | FINGER JOINTED PRIMED | **WM175P**

📏 SCALE: Actual Size

CROWN BACKERS





WM-620 Ogee Base
9/16 × 4-1/4

 Pine | FINGER JOINTED PRIMED | **WM620P**
 Pine | STAIN GRADE | **WM620S**



WM-750 Beaded Base
9/16 × 4-1/4

 Pine | FINGER JOINTED PRIMED | **WM750P**
 Pine | STAIN GRADE | **WM750S**



WM-432E
9/16 × 5-1/2

 Pine | FINGER JOINTED PRIMED | **WM432EPE1E**

Walls & Ceilings

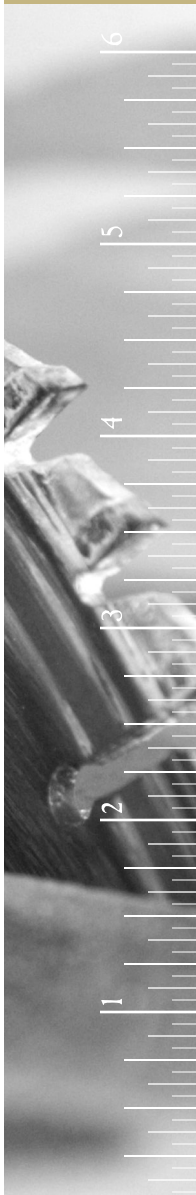

SCALE: Actual Size

CROWN BACKERS



WM-618 Ogee Base

9/16 × 5-1/4

 Pine | FINGER JOINTED PRIMED | **WM618P**

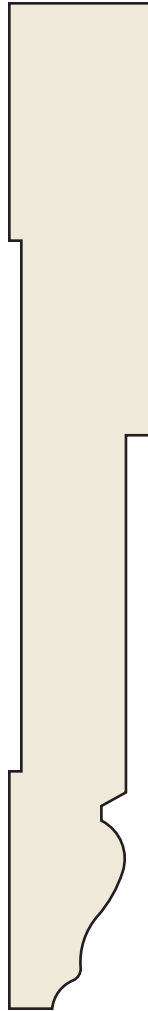

SM-266 Bates' Base



3/4 × 5-1/4

 Poplar | FINGER JOINTED PRIMED | **SM266POP**



SM-66 One Piece Ogee Base

11/16 × 5-1/4

 Flex | **610FT12**
 Pine | FINGER JOINTED PRIMED | **SM66FPR**
 Pine | STAIN GRADE | **SM66**

 SCALE: Actual Size

CROWN BACKERS



LWM-752 Beaded Base
9/16 × 5-1/4

 Pine | FINGER JOINTED PRIMED | WM751P



SM-97 Base
13/16 × 5-1/2

 Poplar | FINGER JOINTED PRIMED | POPBSM97FPR

Walls & Ceilings

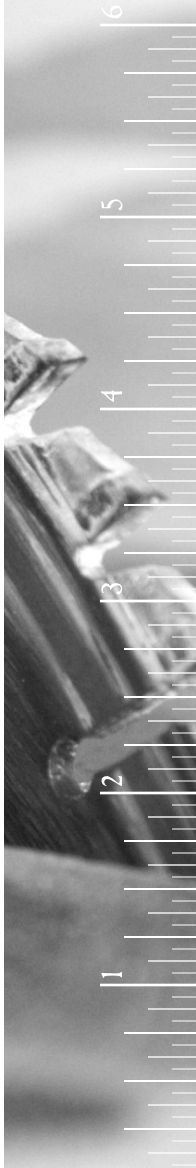

 SCALE: Actual Size

CROWN COMBINATIONS

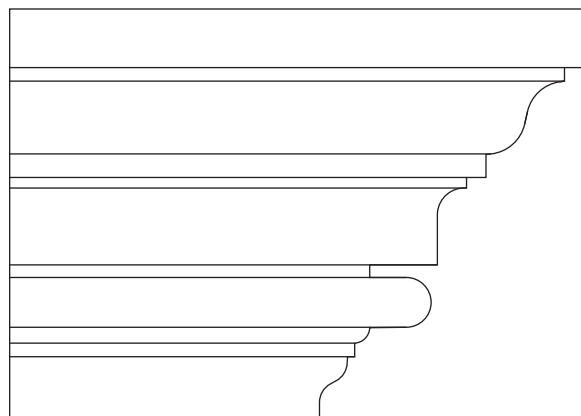
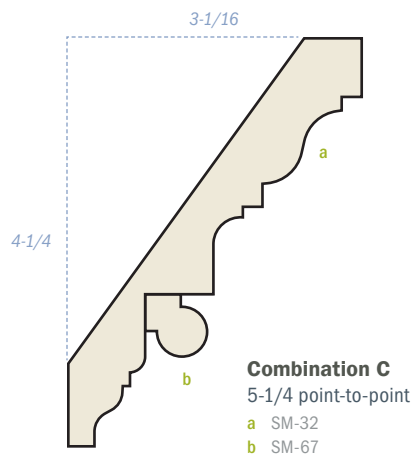
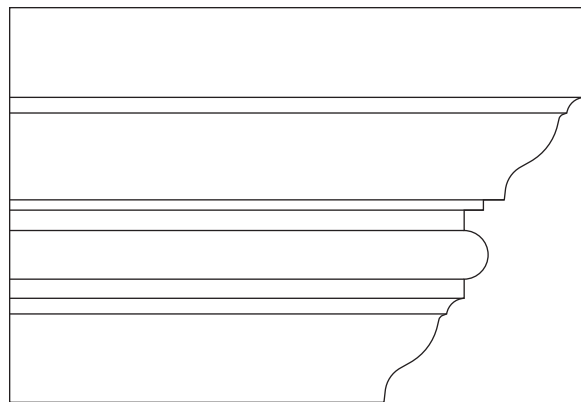
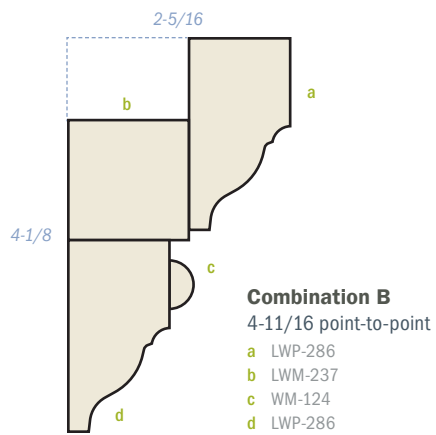
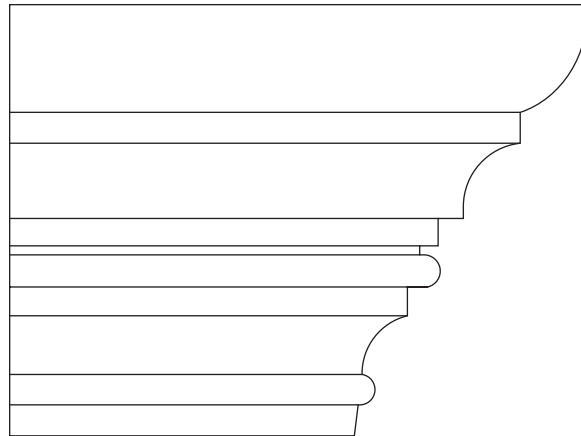
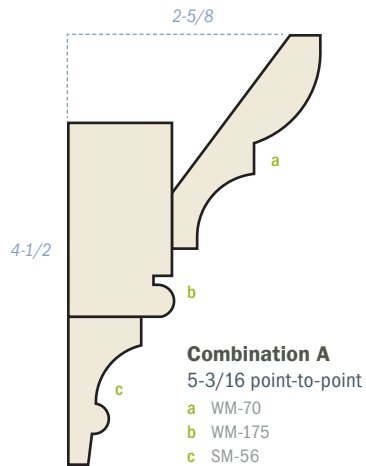

SCALE: 50%

CROWN COMBINATIONS

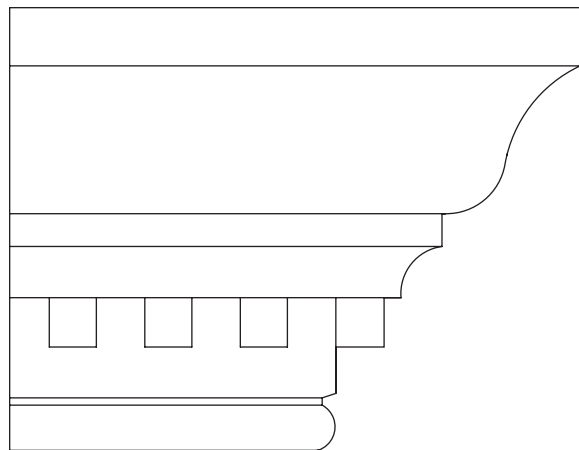
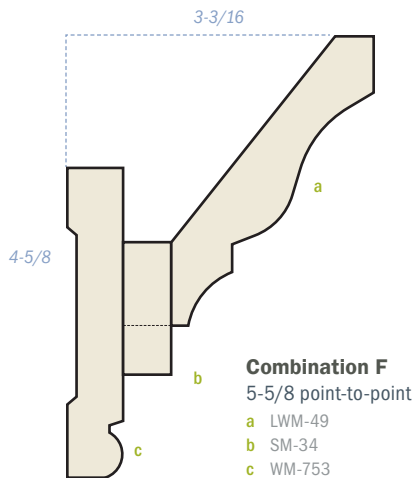
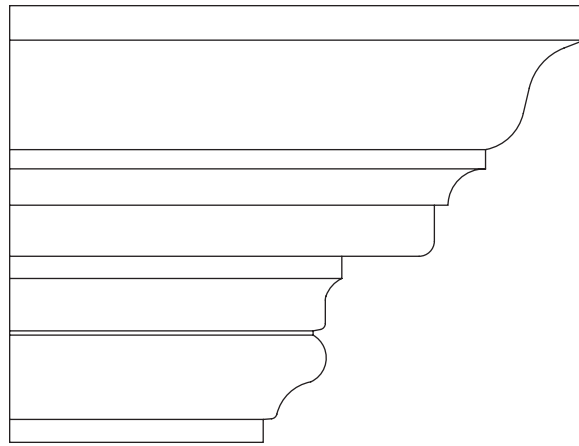
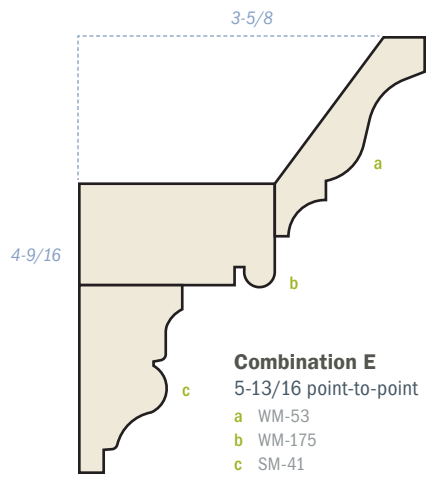
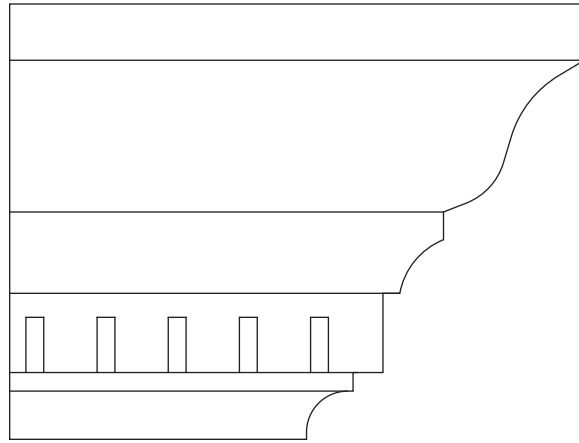
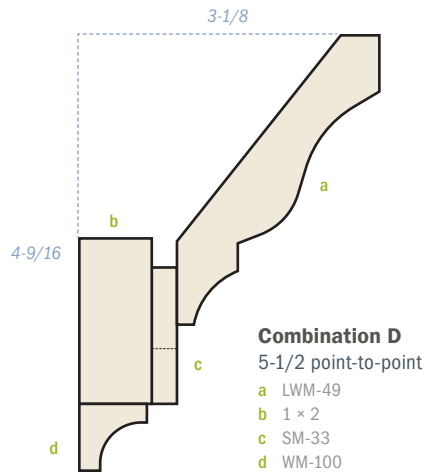

SCALE: 50%

Walls & Ceilings

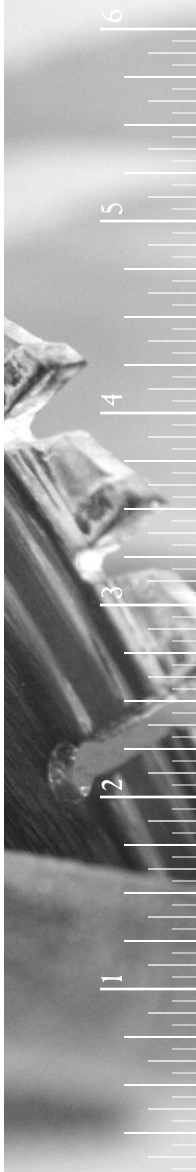

CROWN COMBINATIONS

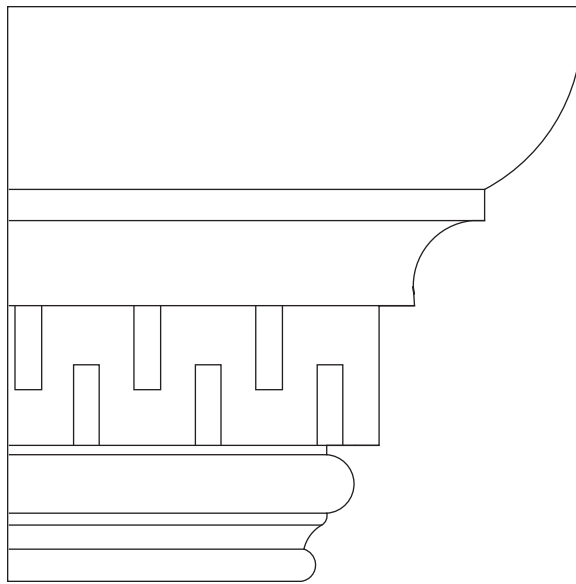
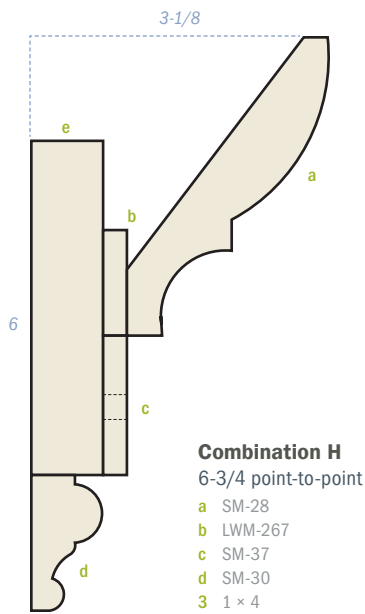
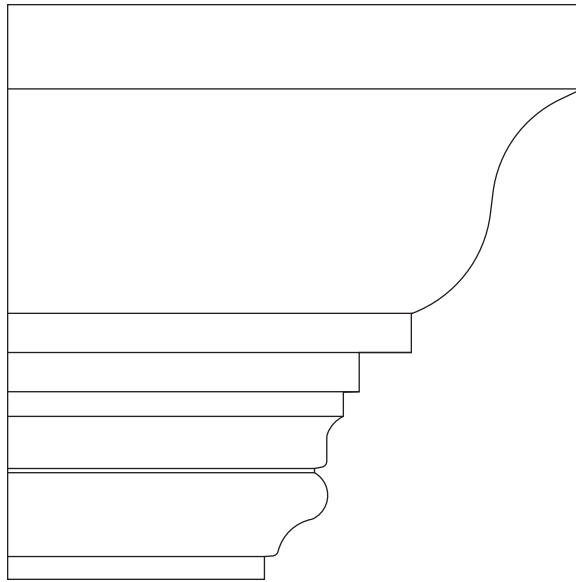
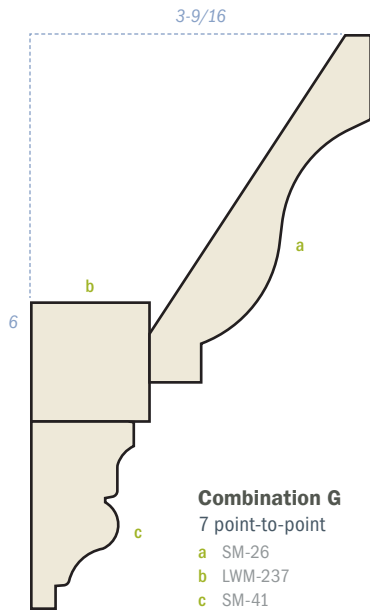

SCALE: 50%

CROWN COMBINATIONS

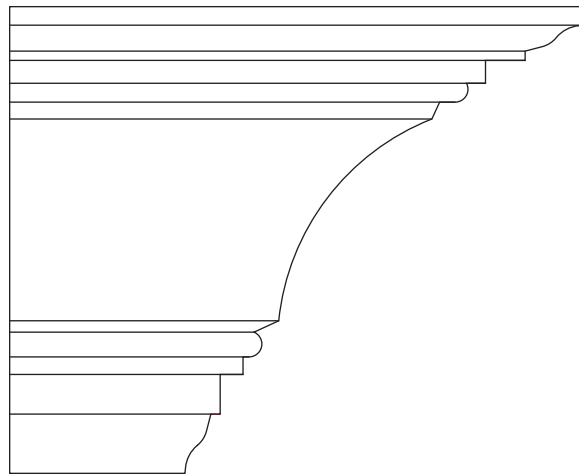
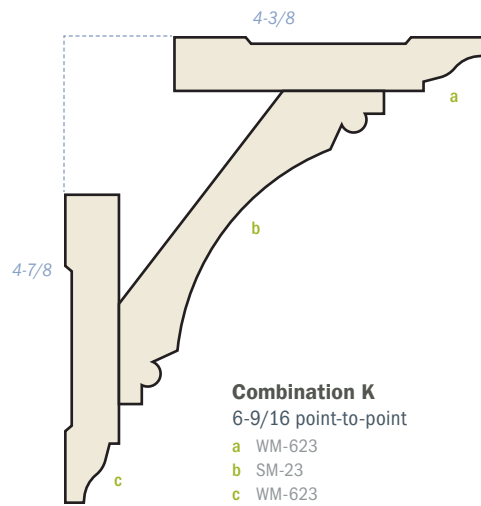
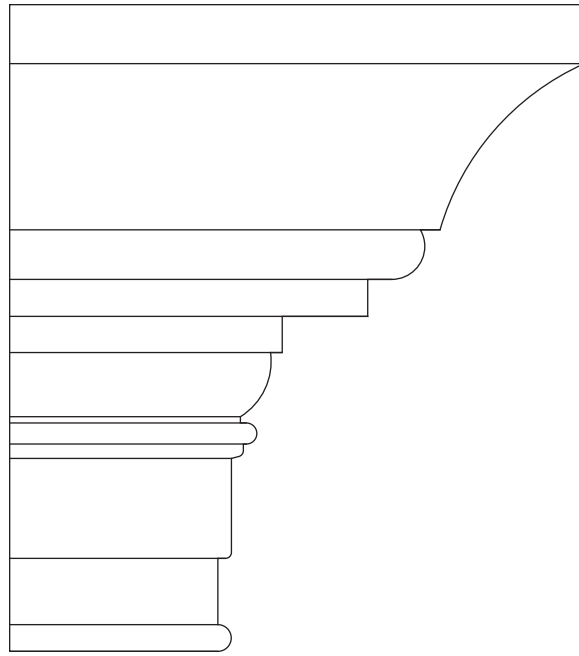
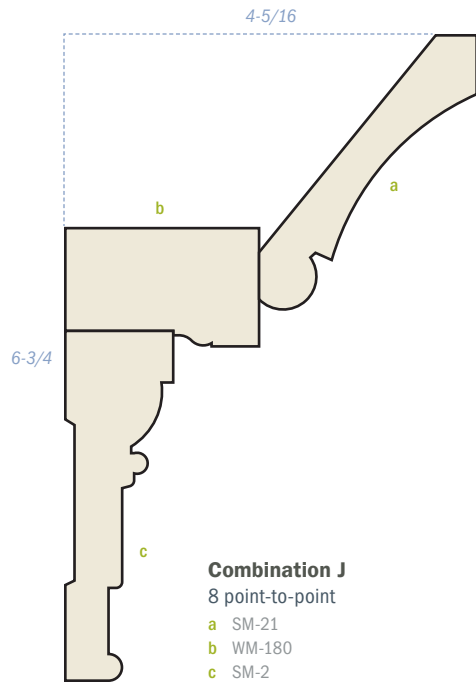

SCALE: 50%

Walls & Ceilings

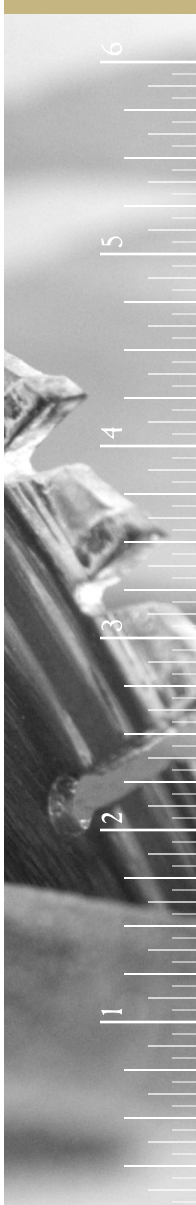

CROWN COMBINATIONS

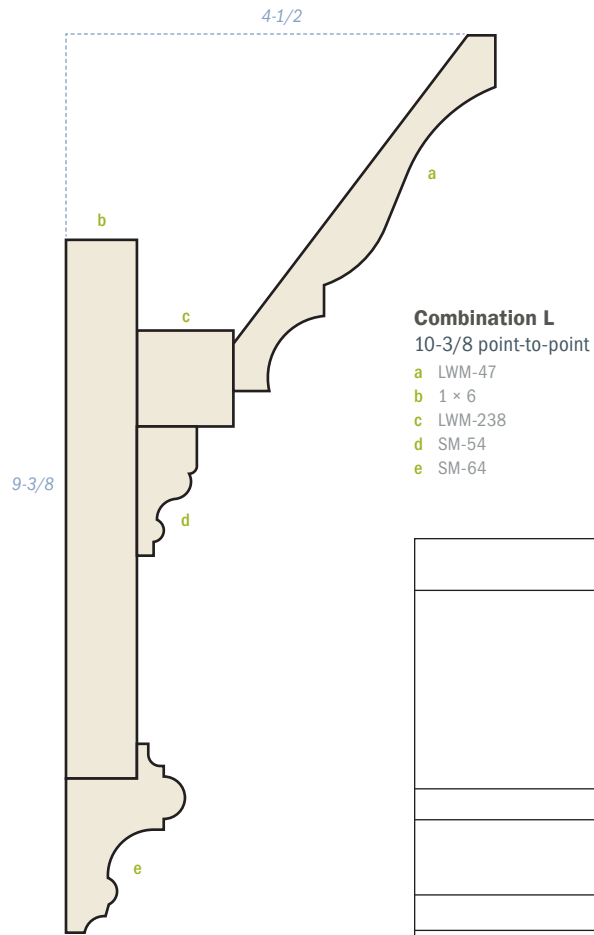

- Combination L**
10-3/8 point-to-point
- a LWM-47
 - b 1 x 6
 - c LWM-238
 - d SM-54
 - e SM-64

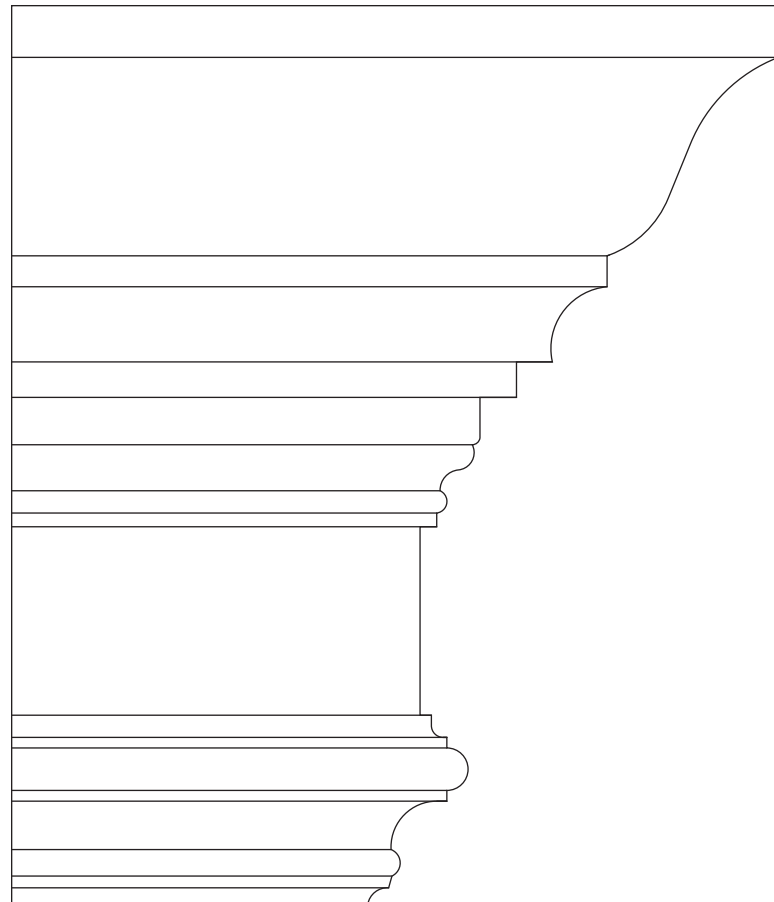

SCALE: 50%

CROWN COMBINATIONS

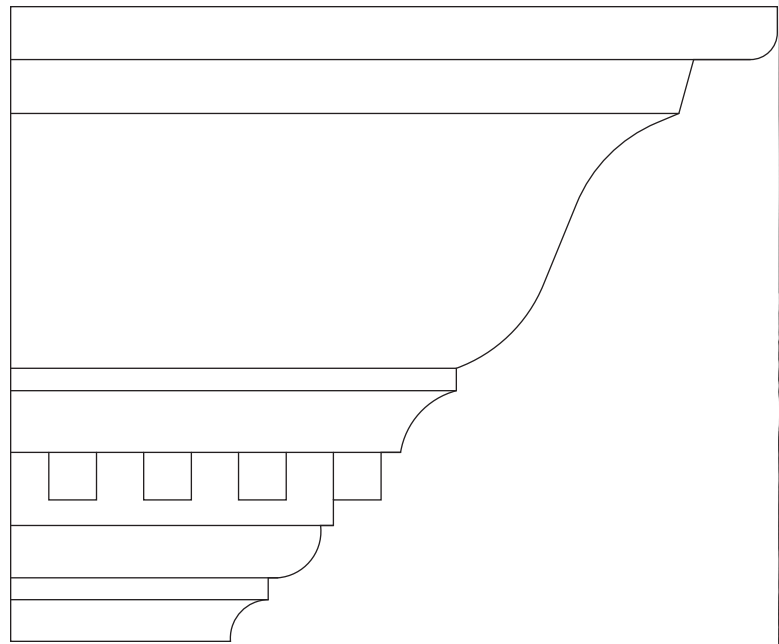
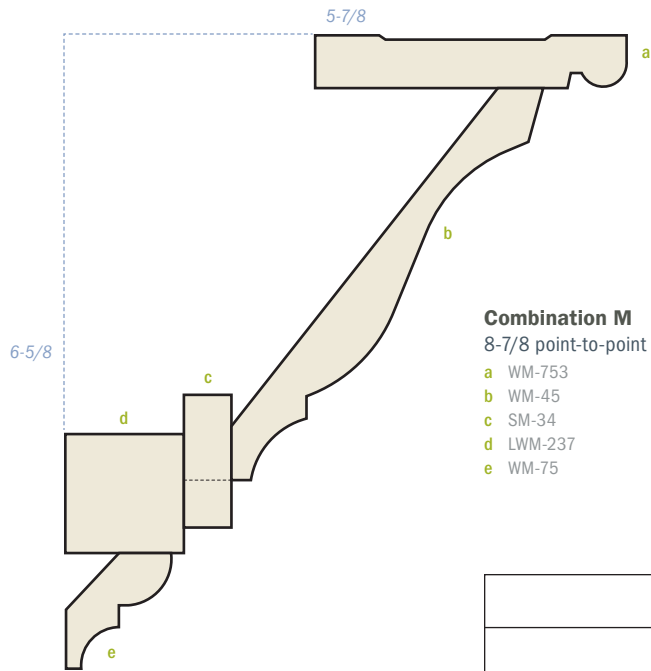

Walls & Ceilings

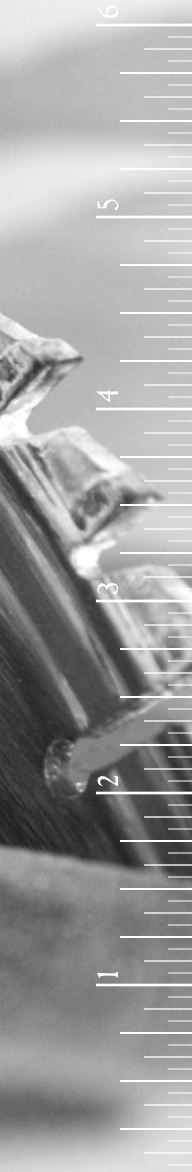

SCALE: 50%

CROWN COMBINATIONS

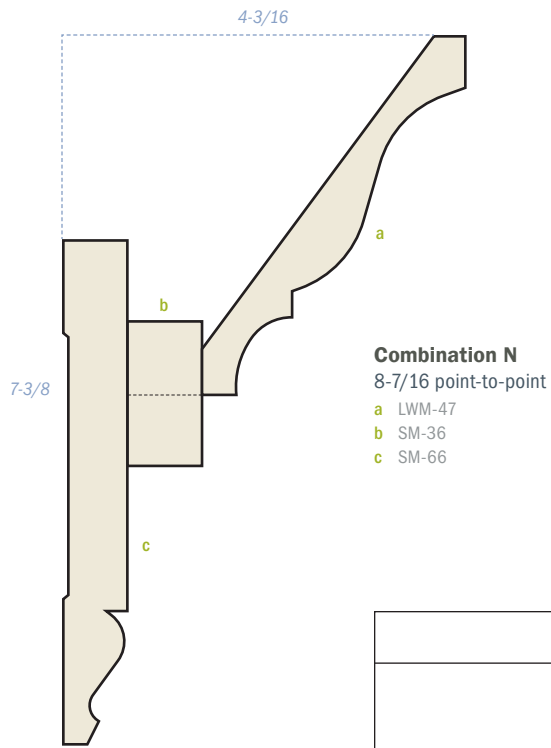

Combination N
8-7/16 point-to-point
a LWM-47
b SM-36
c SM-66

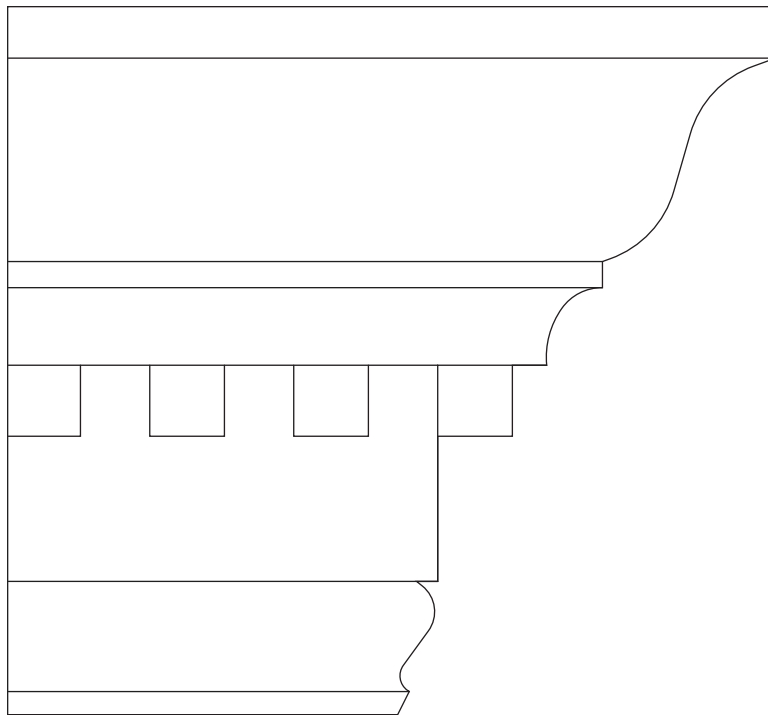

SCALE: 50%

CROWN COMBINATIONS

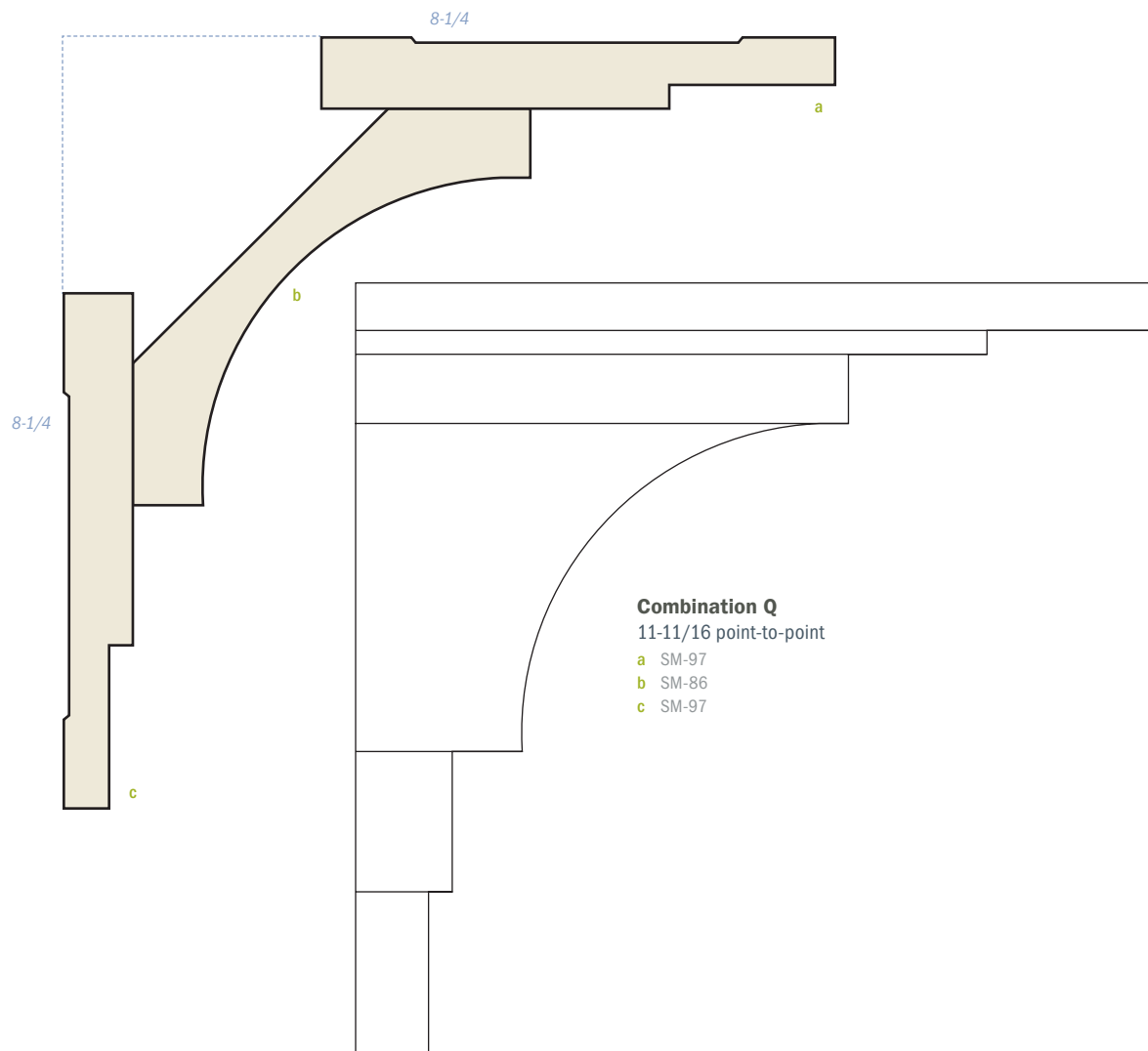
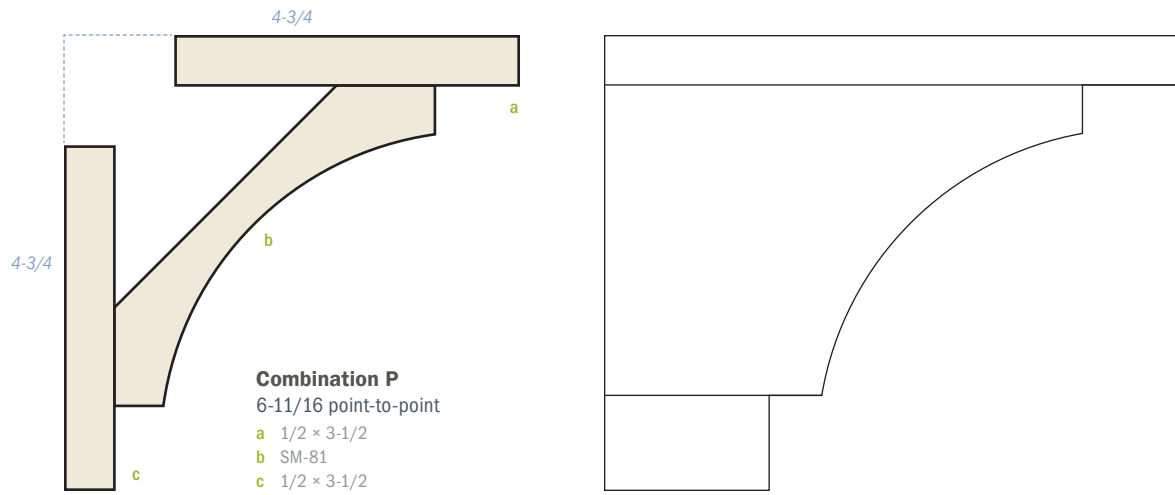

SCALE: 50%

Walls & Ceilings

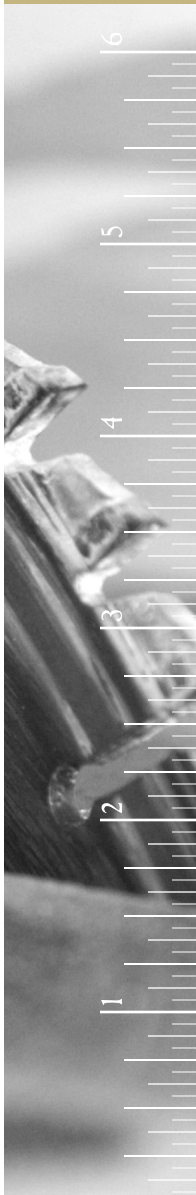

CROWN COMBINATIONS

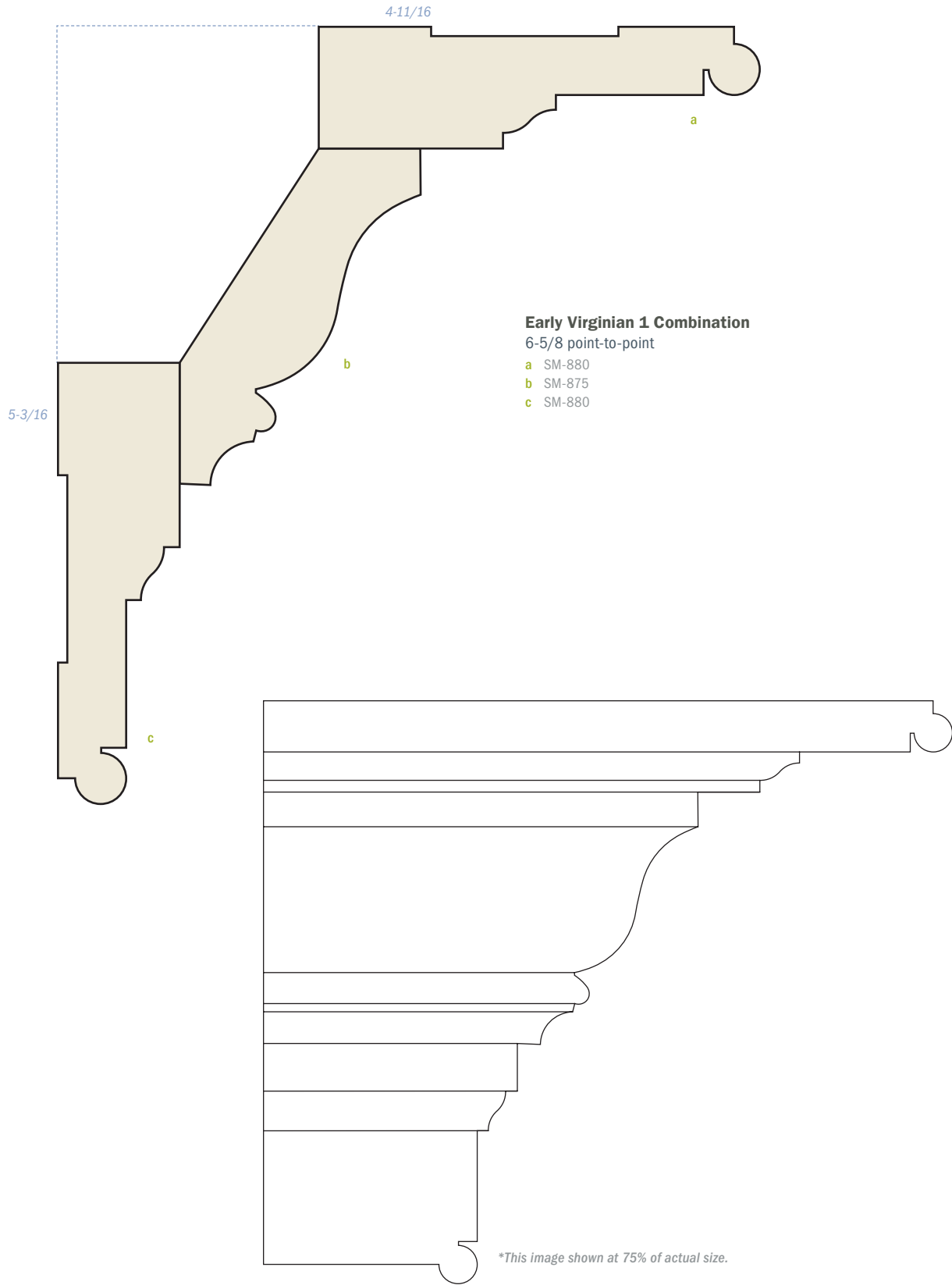

SCALE: Actual Size

CROWN COMBINATIONS

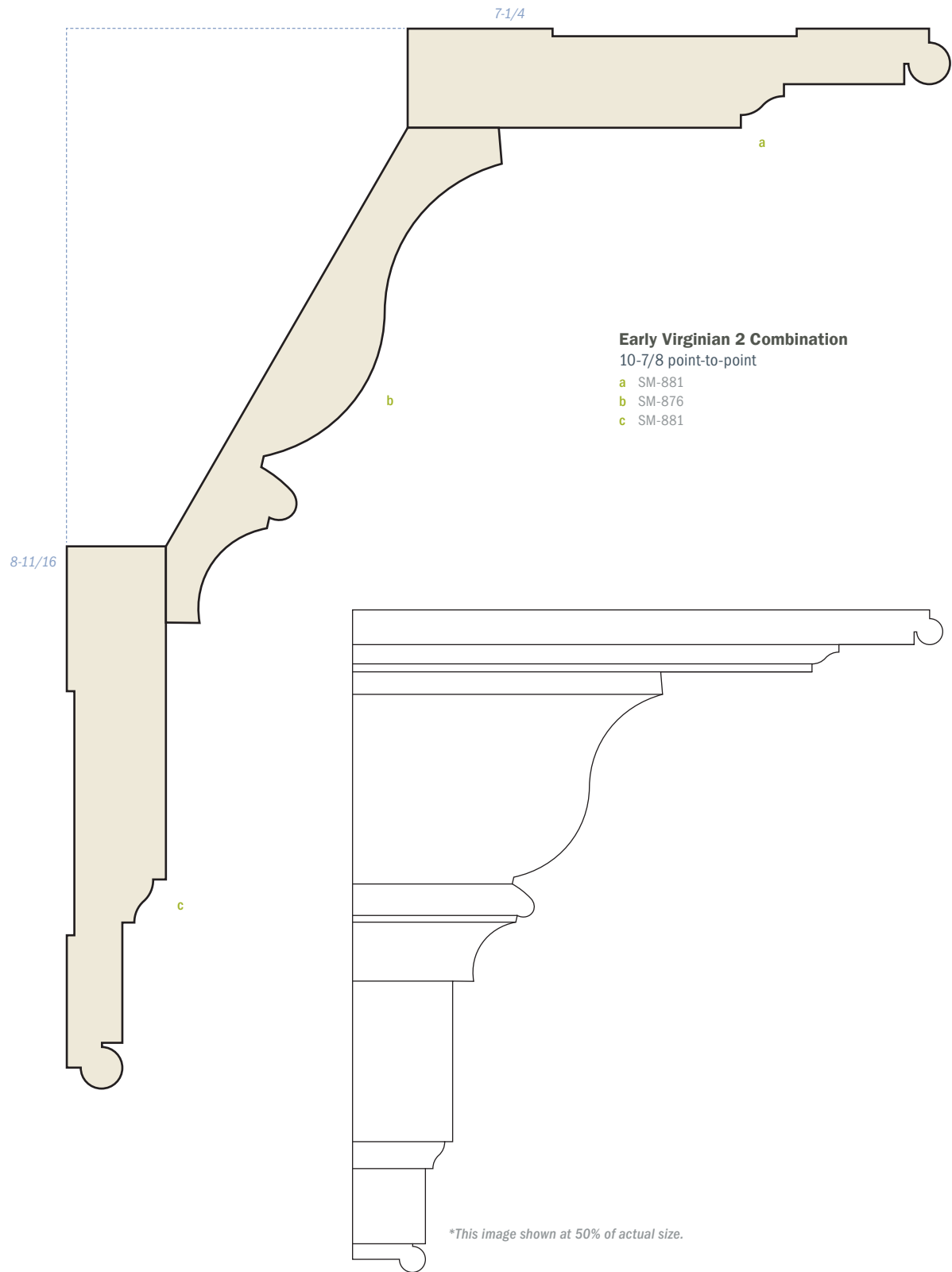

Walls & Ceilings

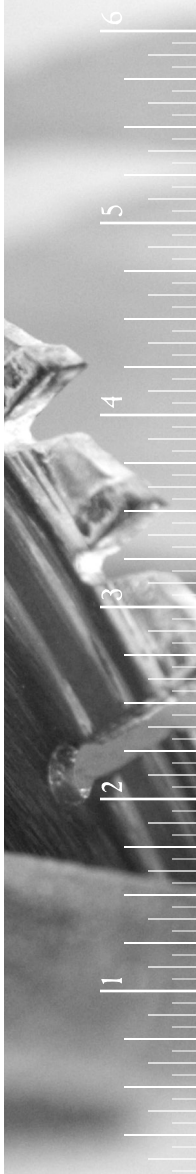

SCALE: 80%

CROWN COMBINATIONS

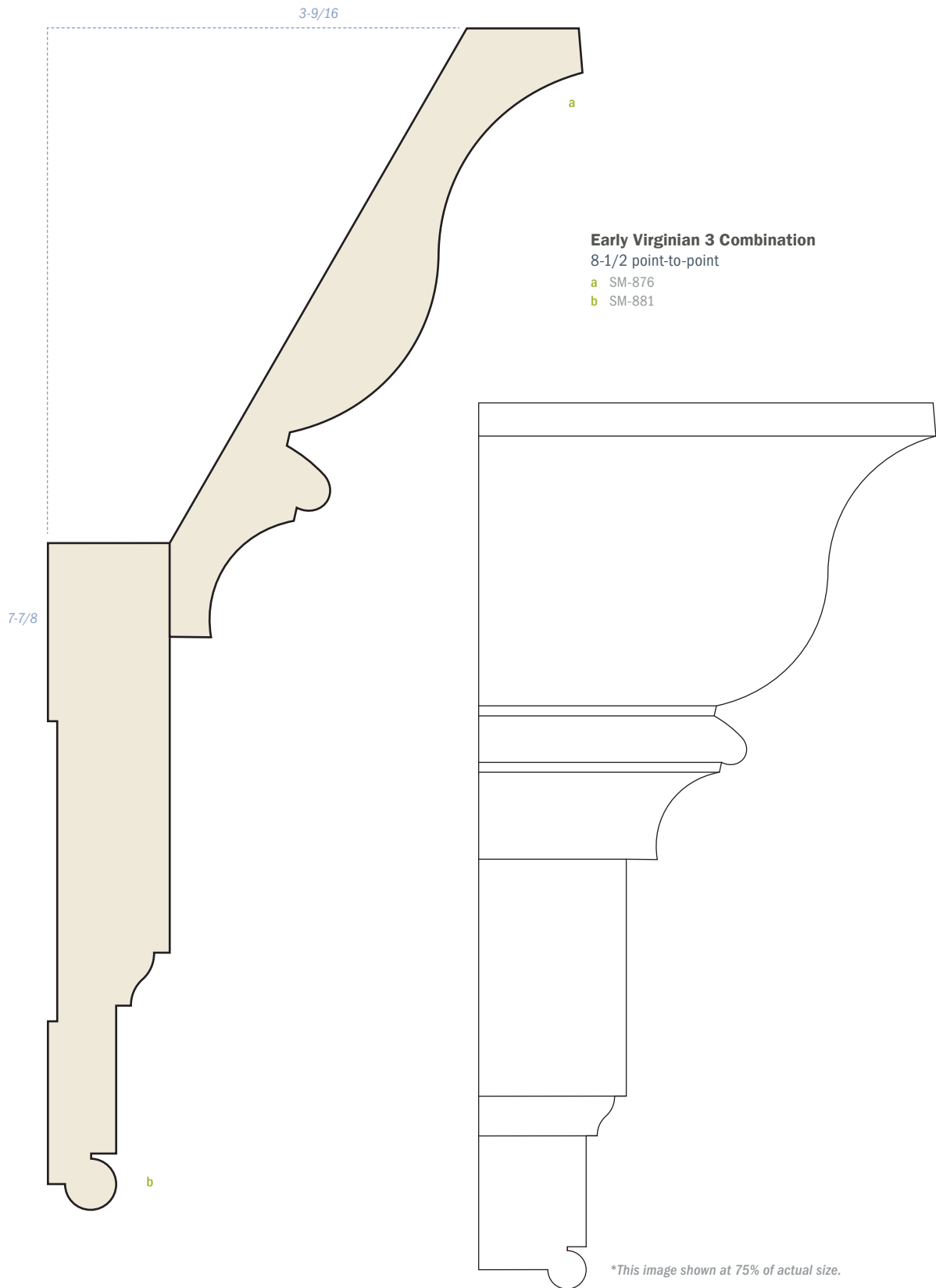

SCALE: Actual Size

CROWN COMBINATIONS

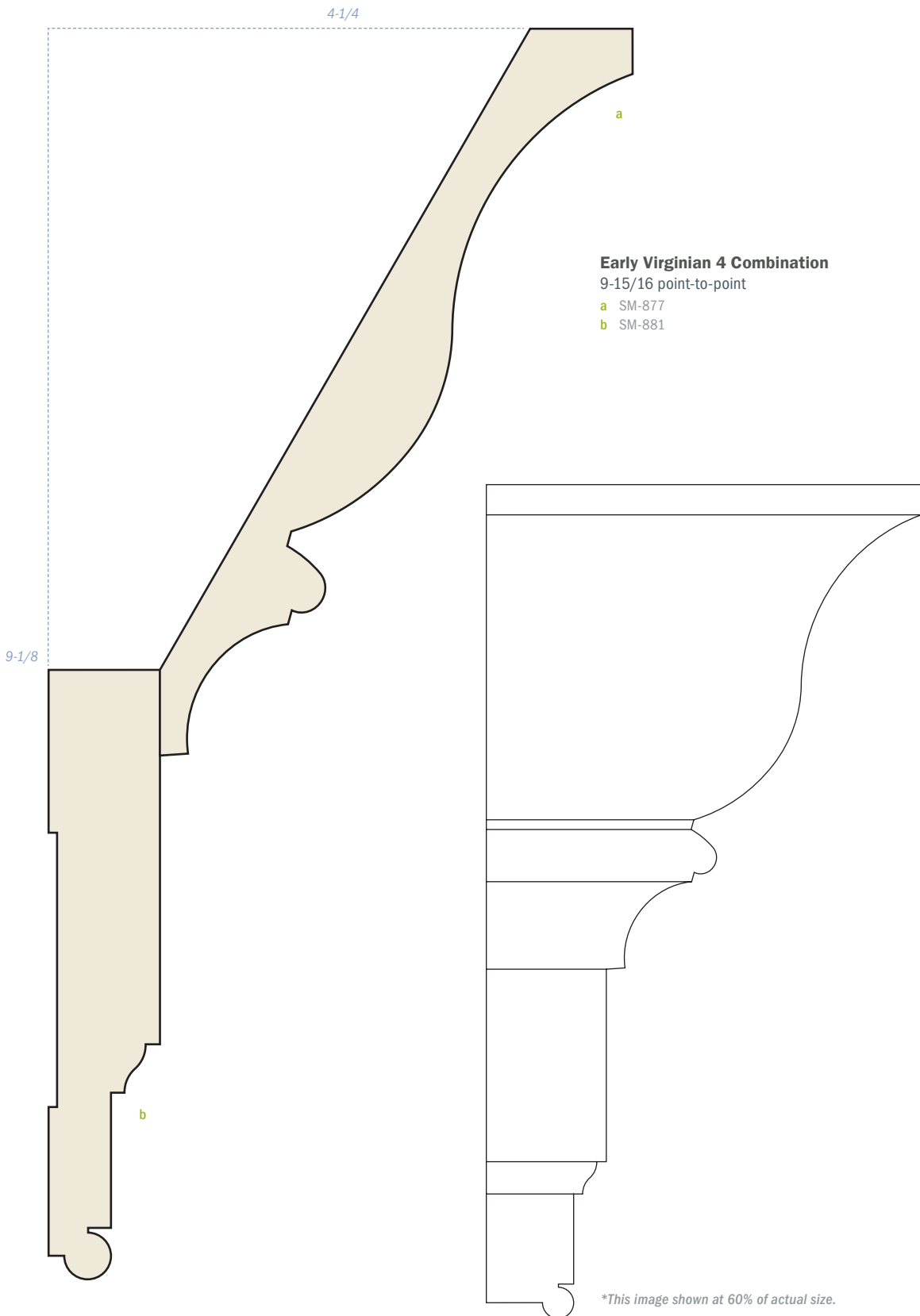

Walls & Ceilings

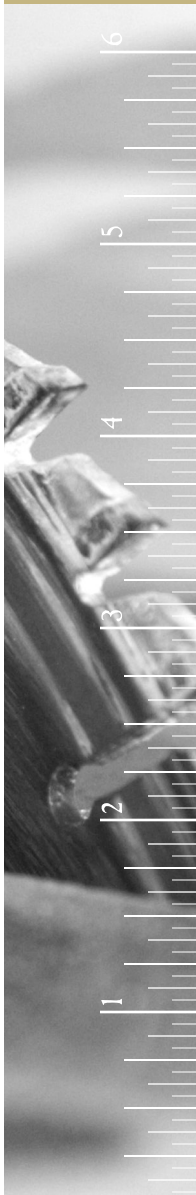

SCALE: 90%

CROWN COMBINATIONS

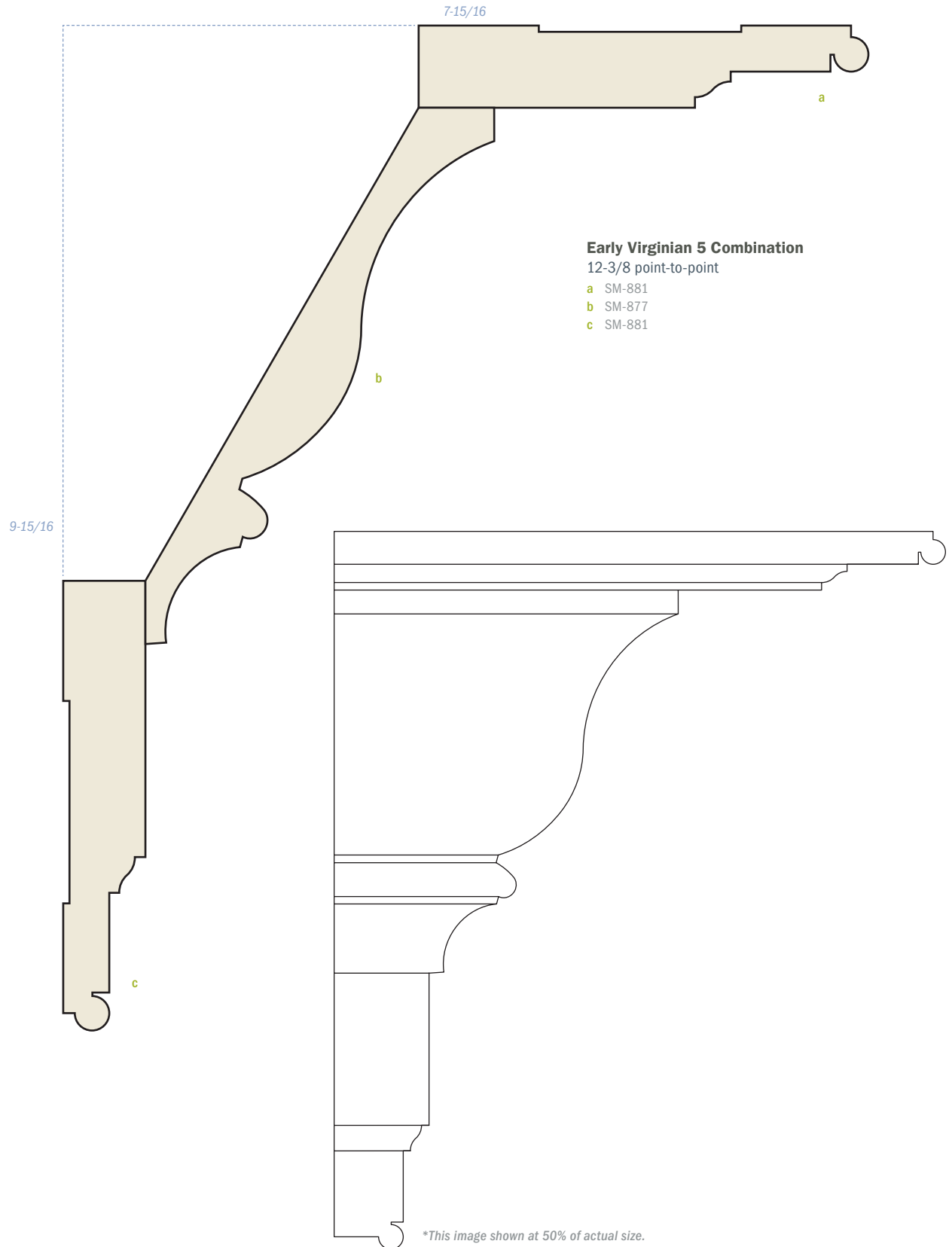

SCALE: 70%

CHAIR RAILS



LWM-224
9/16 × 2-1/2
Pine | STAIN GRADE |
WM224S

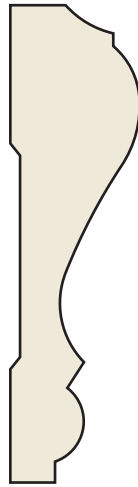

WM-390
11/16 × 2-1/2
Pine | FINGER JOINTED PRIMED |
WM390P



SM-74 Oval Casing
13/16 × 2-1/2
Poplar | FINGER JOINTED PRIMED |
POPCSM74FPR

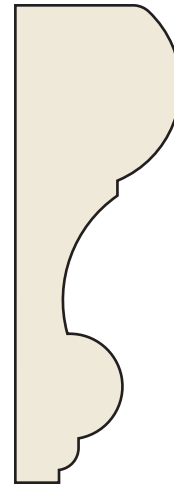

SM-45 Winston
7/8 × 2-1/2
Poplar | FINGER JOINTED PRIMED |
POPCSM45FPR

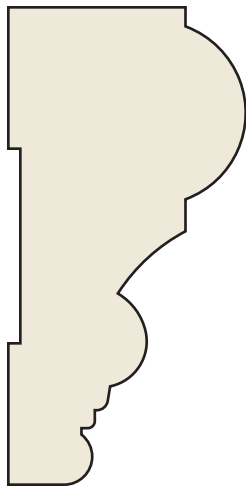

SM-43 Monfalcone
1-1/4 × 2-1/2
Poplar | FINGER JOINTED PRIMED |
POPCSM43FPR



WP-299
9/16 × 2-1/2
Pine | STAIN GRADE |
WM299S

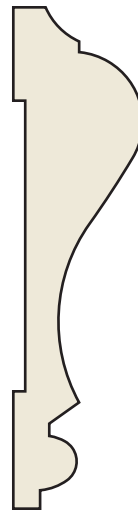

SM-720
11/16 × 2-5/8
Red Oak | STAIN GRADE |
F7200



SM-76 Reeded Casing
13/16 × 2-3/4
Poplar | FINGER JOINTED PRIMED |
POPCSM76FPR

Walls & Ceilings

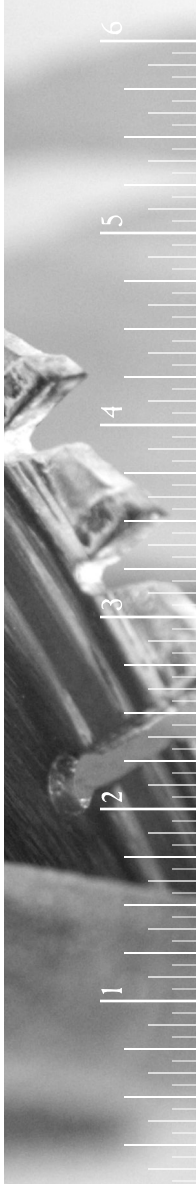

SCALE: Actual Size

CHAIR RAILS

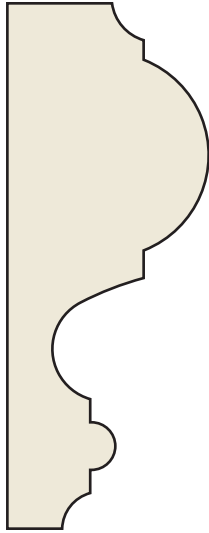

SM-749
1-1/16 × 2-3/4
Oak, Red | STAIN GRADE | **SM7490**

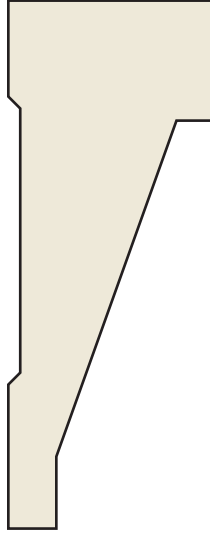

SM-9951
1-1/16 × 2-3/4
Poplar | FINGER JOINTED PRIMED | **POPCRSM9951FPR**

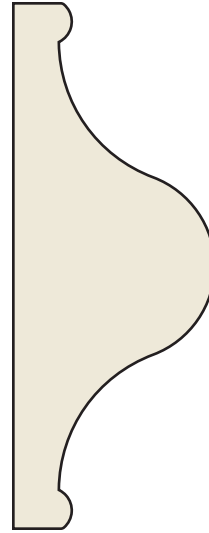

LWM-302
1-1/16 × 2-3/4
Pine | FINGER JOINTED PRIMED | **WM302P**
Pine | STAIN GRADE | **WM302S**

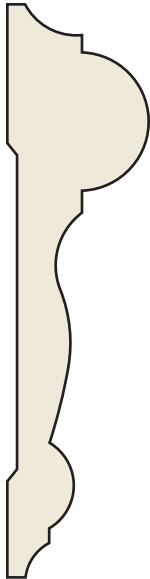

WM-297
3/4 × 3
Flex | **297FT12**
Pine | FINGER JOINTED PRIMED | **WM297P**

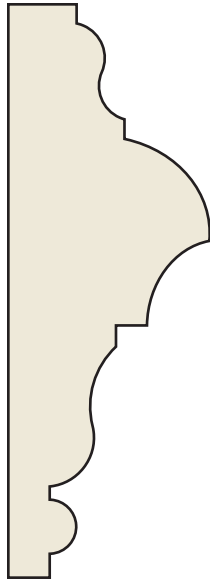

SM-841 Williamsburg
1-1/16 × 3
Cherry | STAIN GRADE | **SM841CH**
Maple | STAIN GRADE | **SM841M**
Oak, Red | STAIN GRADE | **SM841O**
Poplar | SOLID PRIMED | **POPCHEVSM841PR**

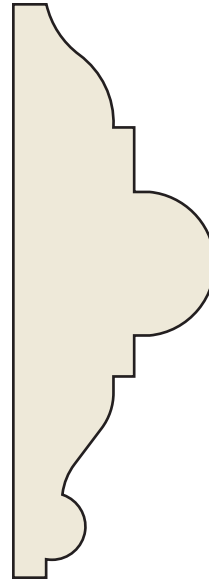

WM-300
1-1/16 × 3
Pine | FINGER JOINTED PRIMED | **WM300P**

SCALE: Actual Size

CHAIR RAILS



ML-958 Backer
 $3/8 \times 3-1/4$
 Pine | STAIN GRADE | LWM956S

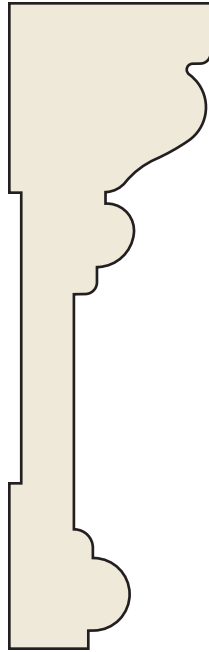

SM-3 Grady Casing
 $1-1/16 \times 3-3/8$
 Pine | FINGER JOINTED PRIMED | SM3FPR

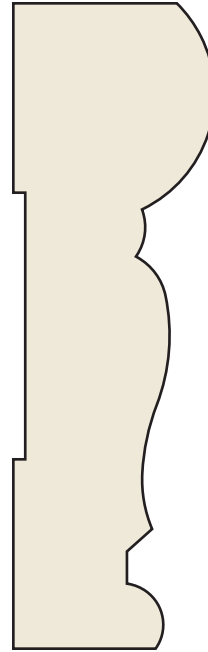

SM-49 Browning
 $1-1/16 \times 3-3/8$
 Poplar | FINGER JOINTED PRIMED | POPCHSM49FPR

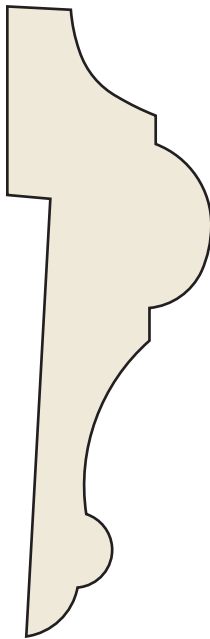

WM-301
 $1-1/16 \times 3-3/8$
 Pine | STAIN GRADE | WM301S

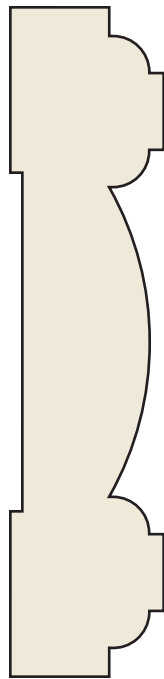

SM-79 Capitol Hill Casing
 $13/16 \times 3-1/2$
 Poplar | FINGER JOINTED PRIMED | POPCSM79FPR

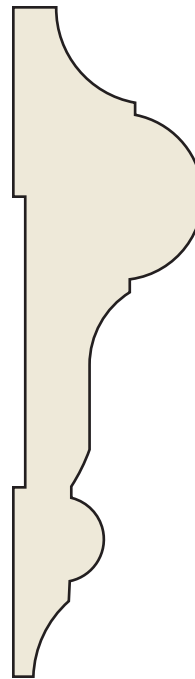

SM-253
 $1 \times 3-1/2$
 Poplar | FINGER JOINTED PRIMED | POPCHSM253FPR

SCALE: Actual Size

Walls & Ceilings

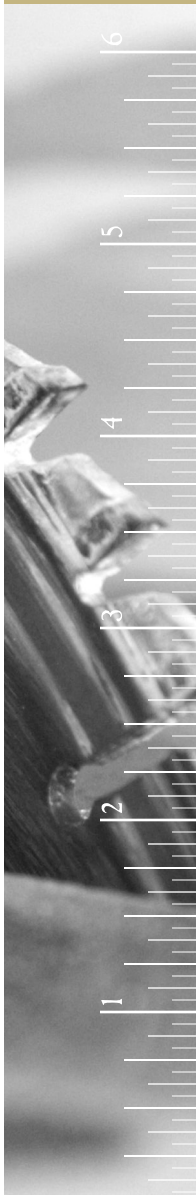

CHAIR RAILS

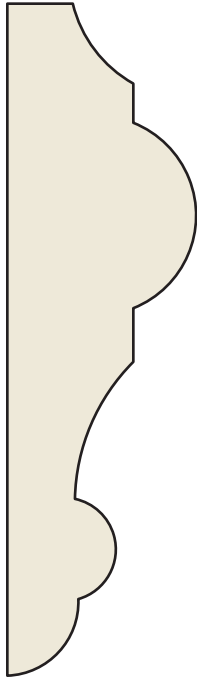

397M Chair Rail

1 × 3-1/2

MDF | SOLID PRIMED | 397MDF16

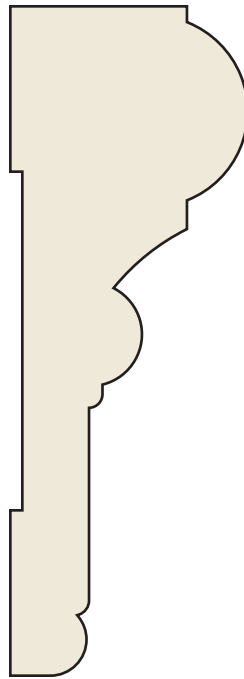

SM-47 Monfalcone

1-1/4 × 3-1/2

Poplar | FINGER JOINTED PRIMED | POPCHSM47FPR

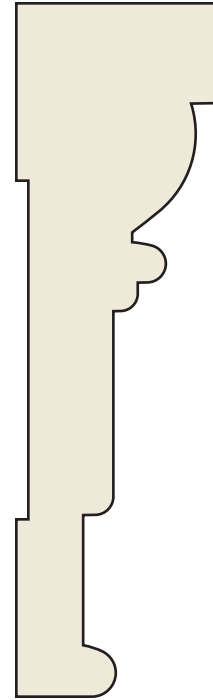

SM-2 Round Hill Casing

1-1/16 × 3-5/8

Poplar | FINGER JOINTED PRIMED | POPCSM2FPR

SCALE: Actual Size

CHAIR RAILS

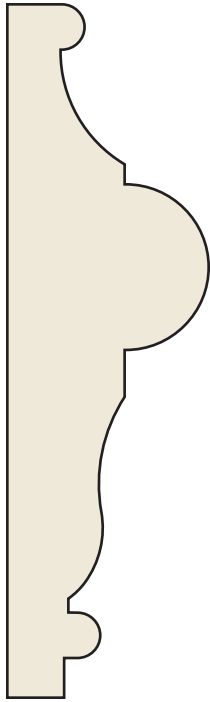

SM-840 Fredericksburg

1-1/16 × 3-5/8

Poplar | SOLID PRIMED |
POPCHEVSM840PR

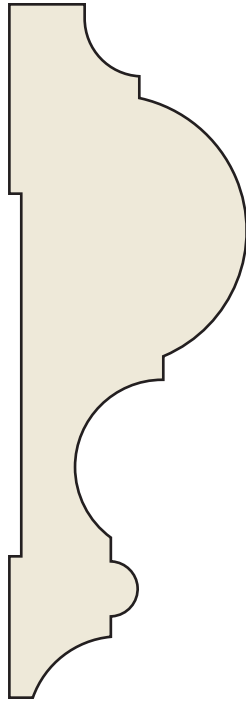

SM-225

1-1/2 × 3-5/8

Poplar | FINGER JOINTED PRIMED |
POPCHSM225FPR

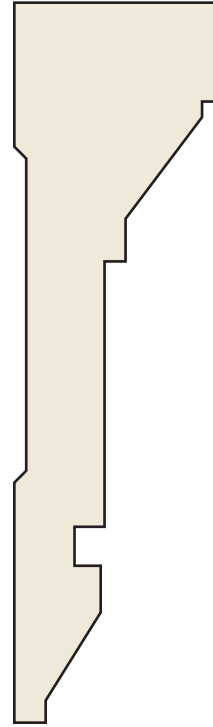

SM-9925

1-1/16 × 3-3/4

Poplar | FINGER JOINTED PRIMED |
POPCSSM9925FPR

Walls & Ceilings

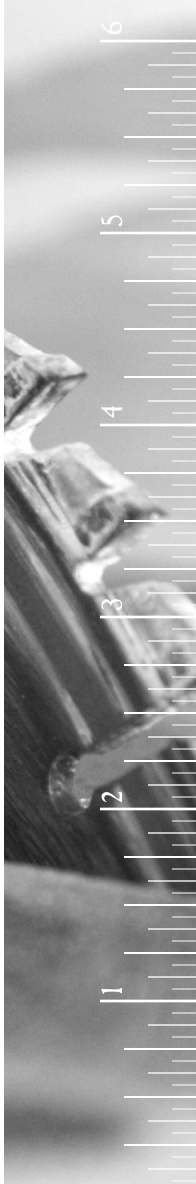

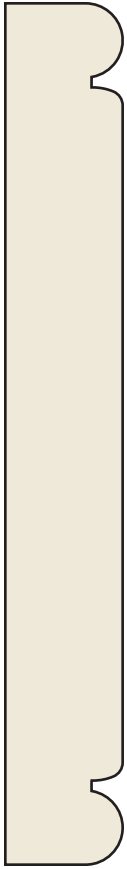

SCALE: Actual Size

CHAIR RAILS



LWM-304 Backer

5/8 × 4-1/2

 Pine | FINGER JOINTED PRIMED | WM304HP
 Pine | STAIN GRADE | WM304S

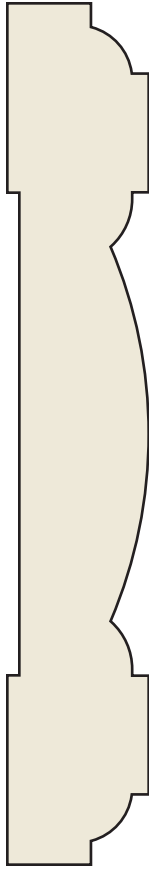

SM-7 Capitol Hill Casing

13/16 × 4-1/2

 Pine | STAIN GRADE | SM07
 Poplar | FINGER JOINTED PRIMED | POPCSM7FPR

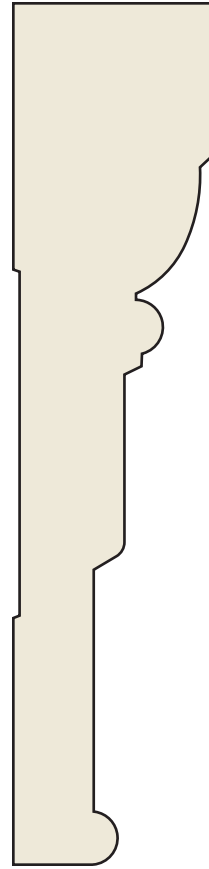

SM-46 Round Hill Casing

1-1/16 × 4-1/2

 Poplar | FINGER JOINTED PRIMED | POPCSM46FPR

 SCALE: Actual Size

CHAIR RAILS

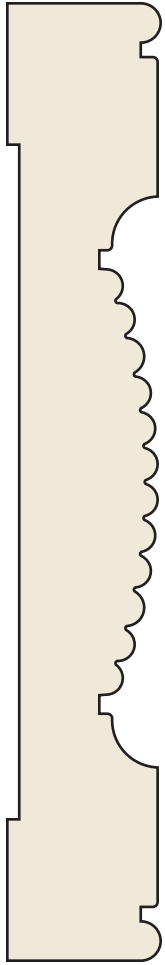

SM-80 Caroline Casing
3/4 × 5

Poplar | FINGER JOINTED PRIMED | POPCSM80FPR

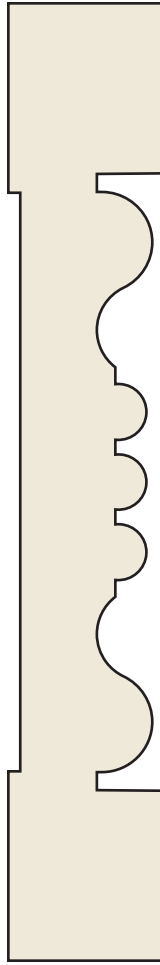

SM-8 Franklin Casing
13/16 × 5

Poplar | FINGER JOINTED PRIMED | POPCSM8FPR

Walls & Ceilings

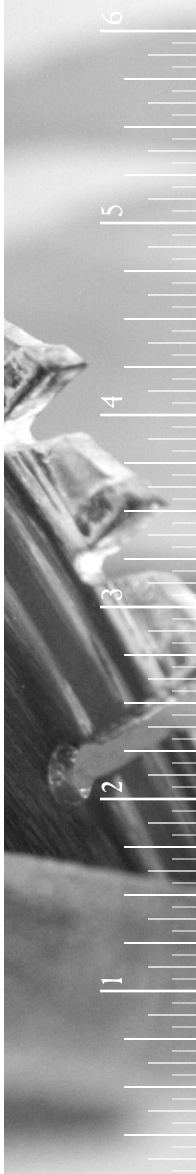

SCALE: Actual Size

CHAIR RAILS

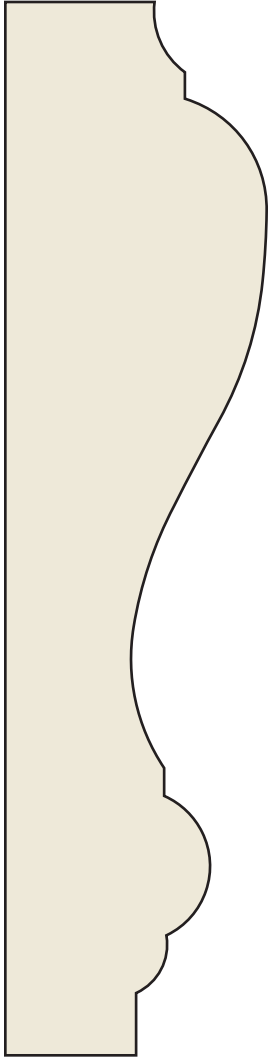

SM-59 Strawberry Hill Mantle

1-3/8 × 5-1/2

Poplar | SOLID PRIMED | POPCHSM59PR

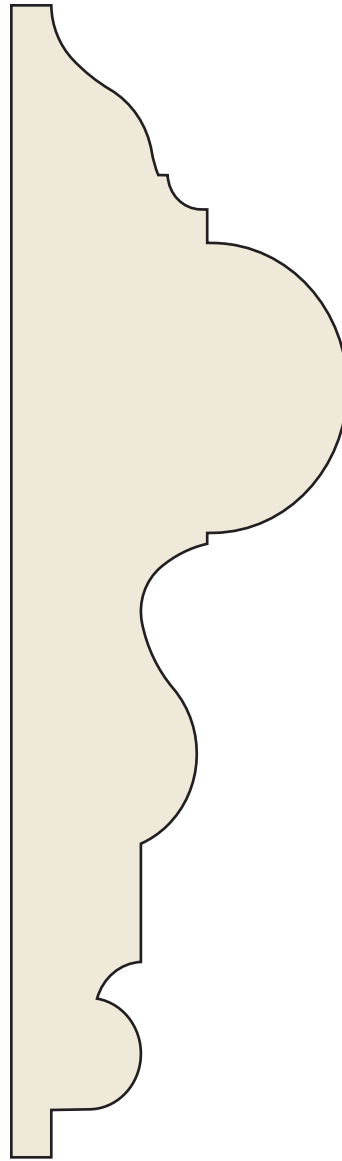

SM-842 OPO

1-3/4 × 6

Poplar | SOLID PRIMED | POPCHEVSM842PR

SCALE: Actual Size

PANELS



A-9
9/16 × 1-1/4

Poplar | SOLID PRIMED |
POPPANA9PR



D-7
5/16 × 7/8

Poplar | SOLID PRIMED |
POPPAND7PR



L-58
7/32 × 1/2

Poplar | SOLID PRIMED |
POPPANL58PR

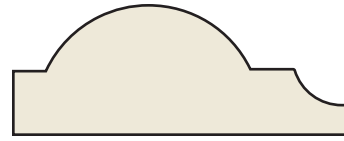

R-42
11/16 × 1-3/4

Poplar | FINGER JOINTED PRIMED |
POPPANR42FPR



LWM-212
5/8 × 2-1/4

Poplar | FINGER JOINTED PRIMED | **WM212P17**



LWM-983
3/8 × 1-5/8

Pine | STAIN GRADE | **WM983SSD**



LWP-113
11/16 × 1-1/4

Pine | STAIN GRADE | **WM113S**



LWP-114
11/16 × 7/8

Pine | STAIN GRADE | **LWP114**



LWP-184
1/2 × 1-1/2

Pine | FINGER JOINTED PRIMED | **WM184P**

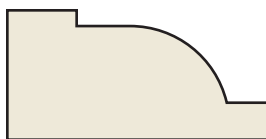

SM-9 Cox's Backband
11/16 × 1-3/8

Pine | STAIN GRADE | **SM9**

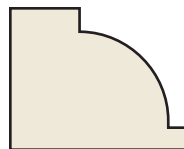

SM-10 Small Cox's Backband
3/4 × 15/16

Pine | STAIN GRADE | **SM010**

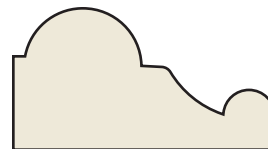

SM-30 Beaded Ogee
3/4 × 1-3/8

Cherry | STAIN GRADE | **SM30CH**
Mahogany | STAIN GRADE | **SM30MAH**
Maple | STAIN GRADE | **SM30M**
Oak, Red | STAIN GRADE | **SM30O**
Pine | FINGER JOINTED PRIMED | **SM30BFS**
Pine | STAIN GRADE | **SM30**

Walls & Ceilings

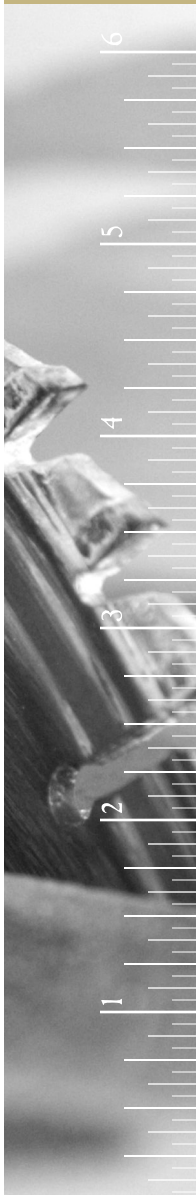

SCALE: Actual Size

PANELS



SM-51
1/2 × 3/4

🌲 Pine | STAIN GRADE | **SM51**



SM-53
3/8 × 1-1/8

🌲 Poplar | SOLID PRIMED | **POPPANSM53PR**



SM-54
5/8 × 1-3/8

🌲 Pine | STAIN GRADE | **SM54**



SM-55
9/16 × 1-1/2

🌲 Pine | FINGER JOINTED PRIMED | **SM55FPR**



SM-56
3/4 × 1-1/2

🌲 Poplar | FINGER JOINTED PRIMED | **POPPANSM56FPR**



SM-57 Raised Panel Mould
9/16 × 2-1/4

🌲 Pine | STAIN GRADE | **SM57**



SM-58
1/2 × 5/8

🌲 Pine | STAIN GRADE | **SM58**

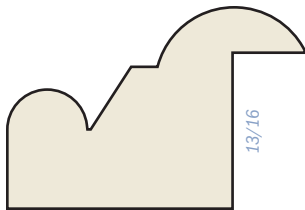

SM-60
1-1/16 × 1-9/16

🌲 Poplar | FINGER JOINTED PRIMED | **POPPANSM60FPR**

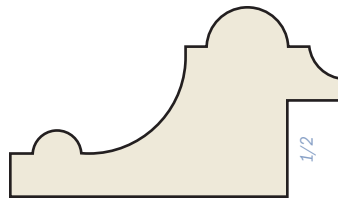

SM-62 Longwood Panel Mould
1 × 1-3/4

🌲 Cherry | STAIN GRADE | **SM62CH**
 🌲 Maple | STAIN GRADE | **SM62M**
 🌲 Oak, Red | STAIN GRADE | **SM62O**
 🌲 Pine | STAIN GRADE | **SM62**
 🌲 Poplar | FINGER JOINTED PRIMED | **POPPANSM62FPR**

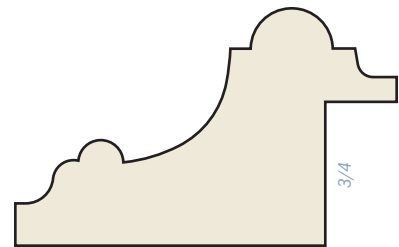

SM-64 Longwood Panel Mould
1-1/4 × 2

🌲 Poplar | SOLID PRIMED | **POPPANSM64PR**



SM-63
9/16 × 1-1/4

🌲 Pine | STAIN GRADE | **SM63**



SM-70 Sticking
3/8 × 1/2

🌲 Pine | STAIN GRADE | **SM70**

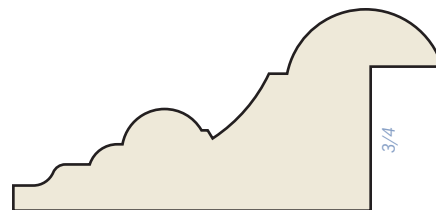

SM-143 Falcon Panel Mould
1-1/16 × 2-1/4

🌲 Poplar | FINGER JOINTED PRIMED | **POPPANSM143FPR**

📏 SCALE: Actual Size

PANELS



SM-729
7/16 × 3/4
Oak, Red | STAIN GRADE | **SM7290**



WM-183
9/16 × 1-1/8
Pine | STAIN GRADE | **WM183S**



SM-733
1/2 × 1-1/2
Cherry | STAIN GRADE | **SM733CH**
Maple | STAIN GRADE | **SM733M**
Oak, Red | STAIN GRADE | **SM733O**

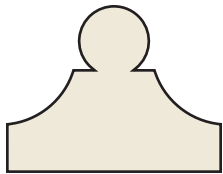

SM-850 Spotswood Panel Mould
7/8 × 1-1/8
Poplar | SOLID PRIMED | **POPPANEVSM850PR**

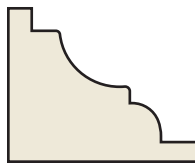

SM-853 Alexandria Panel Mould
13/16 × 1
Poplar | SOLID PRIMED | **POPPANEVSM853PR**

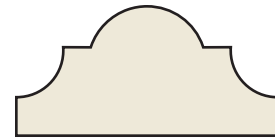

WM-134 Flat Astragal
11/16 × 1-3/8
Pine | STAIN GRADE | **WM134S**

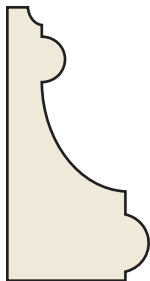

SM-860 Fairfax Base Cap
3/4 × 1-7/16
Poplar | SOLID PRIMED | **POPBCEVSM860PR**

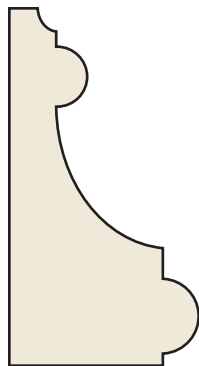

SM-862 Fairfax Base Cap
1 × 1-7/8
Poplar | SOLID PRIMED | **POPBCEVSM862PR**

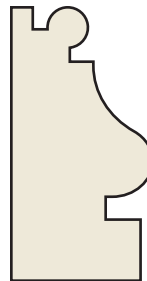

SM-865 Smoot Base Cap
3/4 × 1-7/16
Poplar | SOLID PRIMED | **POPBCEVSM865PR**

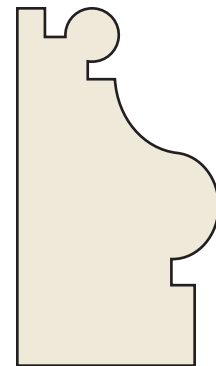

SM-867 Smoot Base Cap
1-1/16 × 1-7/8
Poplar | SOLID PRIMED | **POPBCEVSM867PR**

Walls & Ceilings

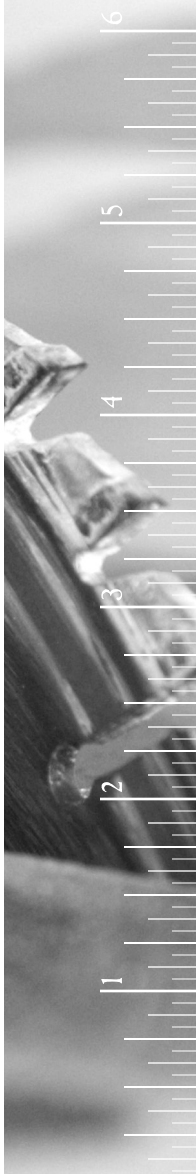

SCALE: Actual Size

PANELS

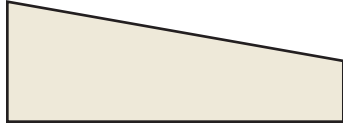

SM-9930

5/8 × 1-3/4

Poplar | FINGER JOINTED PRIMED | POPBCSM9930FPR

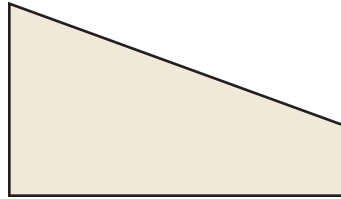

SM-9931

1 × 1-3/4

Poplar | FINGER JOINTED PRIMED | POPBCSM9931FPR

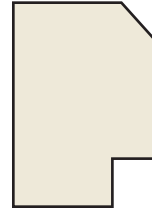

SM-9932

3/4 × 1-1/16

Poplar | FINGER JOINTED PRIMED | POPBCSM9932FPR

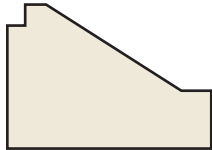

SM-9934

3/4 × 1-1/16

Poplar | FINGER JOINTED PRIMED | POPBCSM9934FPR

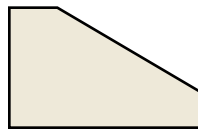

SM-9935

5/8 × 1

Poplar | FINGER JOINTED PRIMED | POPBCSM9935FPR

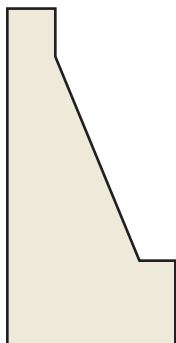

SM-9950

7/8 × 1-3/4

Poplar | FINGER JOINTED PRIMED | POPBCSM9950FPR

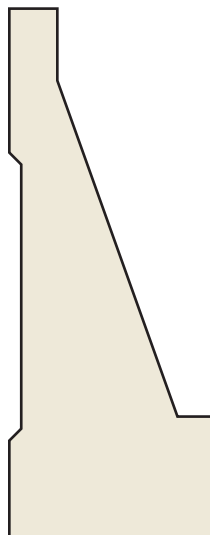

SM-9951

1-1/16 × 2-3/4

Poplar | FINGER JOINTED PRIMED | POPBCSM9950FPR

SCALE: Actual Size

CORNERS, INSIDE AND OUTSIDE



SM-67 Return Bead

5/8 × 5/8

-  Cherry | STAIN GRADE | **SM67CH**
-  Maple | STAIN GRADE | **SM67M**
-  Oak, Red | STAIN GRADE | **SM67O**
-  Pine | STAIN GRADE | **SM67**

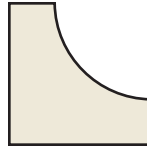

SM-601 Inside Corner

3/4 × 3/4

-  Oak, Red | STAIN GRADE | **SM601O**

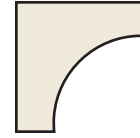

WM-100 Cove

11/16 × 11/16

-  Pine | STAIN GRADE | **WM100S**

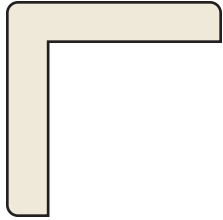

WM-205 Sanitary

1-1/8 × 1-1/8

-  Pine | STAIN GRADE | **WM205S**

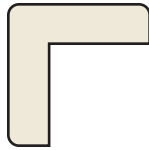

SM-651 Outside Corner

3/4 × 3/4

-  Oak, Red | STAIN GRADE | **SM651O**

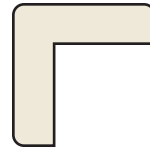

WM-206 Sanitary

3/4 × 3/4

-  Pine | STAIN GRADE | **WM206S**

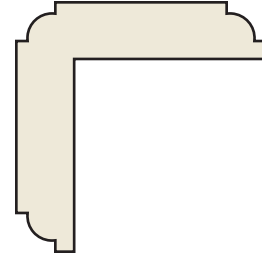

WM-201 Worked

1-15/16 × 1-15/16

-  Pine | STAIN GRADE | **WM201S**

Walls & Ceilings

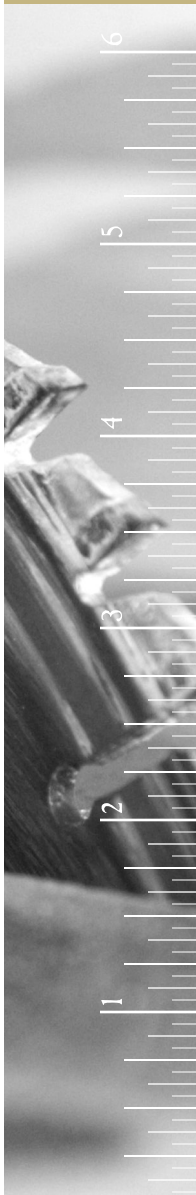

SCALE: Actual Size

CORNERS, INSIDE AND OUTSIDE



A-9

9/16 × 1-1/4

Poplar | SOLID PRIMED | POPPANA9PR

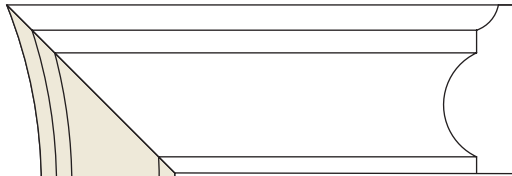

A-9 Radius Corner

9/16 × 1-1/4

Flex | PAINT GRADE | A9FT

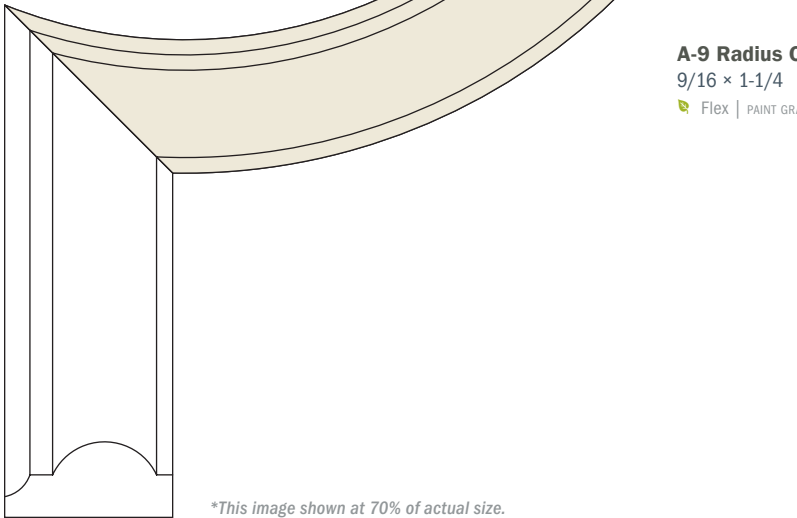

**This image shown at 70% of actual size.*

SCALE: Actual Size

CORNERS, INSIDE AND OUTSIDE



D-7

5/16 × 7/8

Poplar | SOLID PRIMED | POPPAND7PR

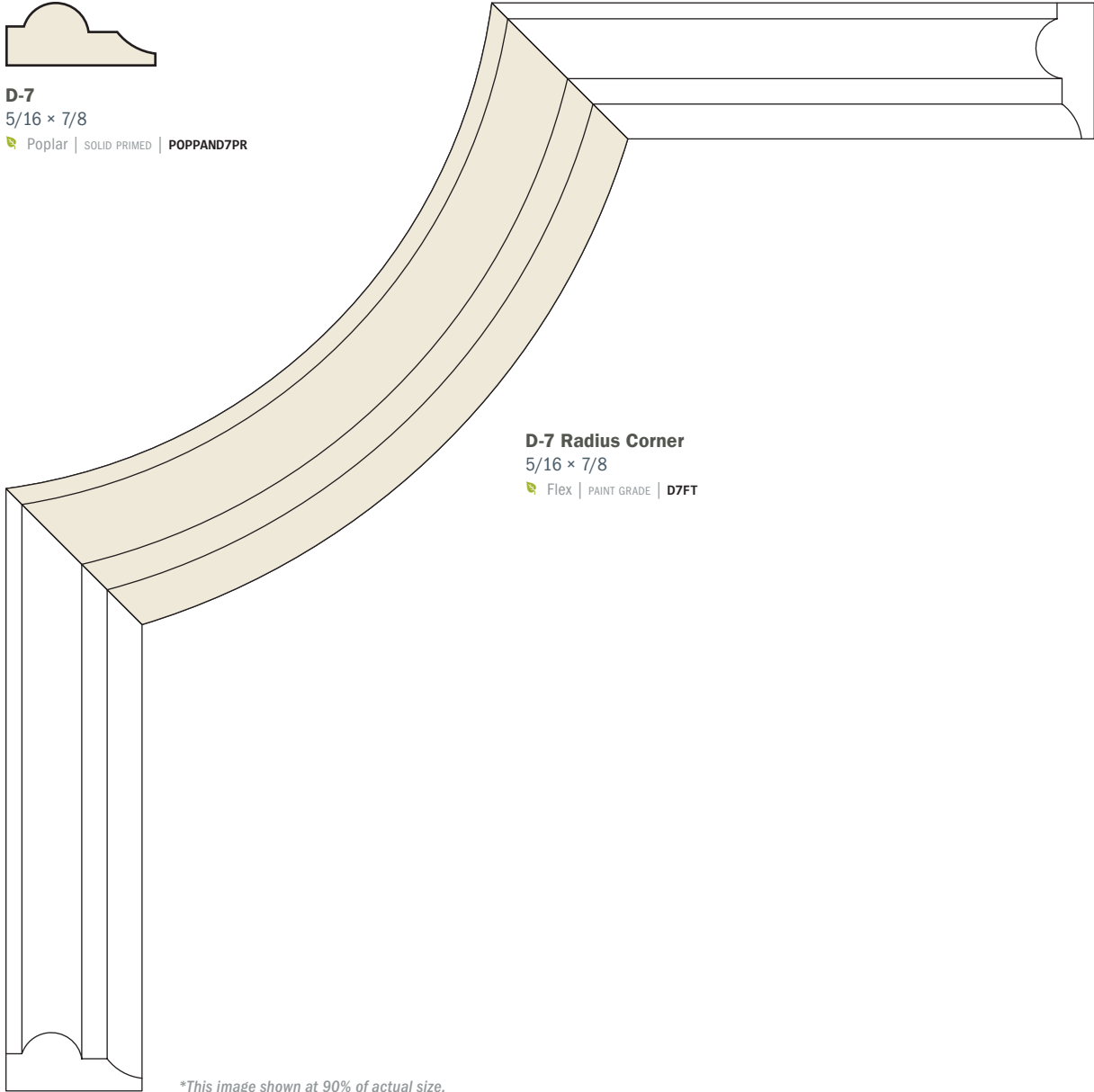

D-7 Radius Corner

5/16 × 7/8

Flex | PAINT GRADE | D7FT

*This image shown at 90% of actual size.

Walls & Ceilings

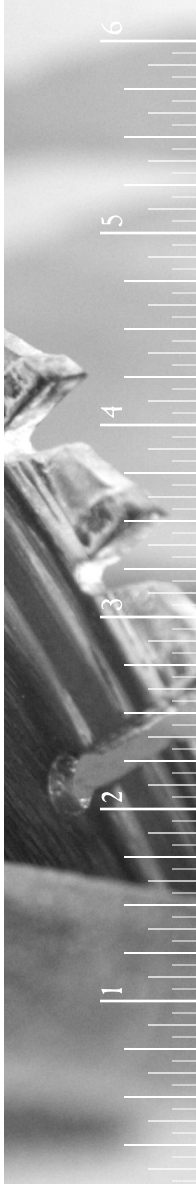

SCALE: Actual Size

CORNERS, INSIDE AND OUTSIDE

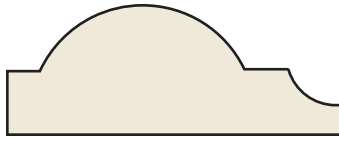

R-42

11/16 × 1-3/4

Poplar | FINGER JOINTED PRIMED | POPPANR42FPR

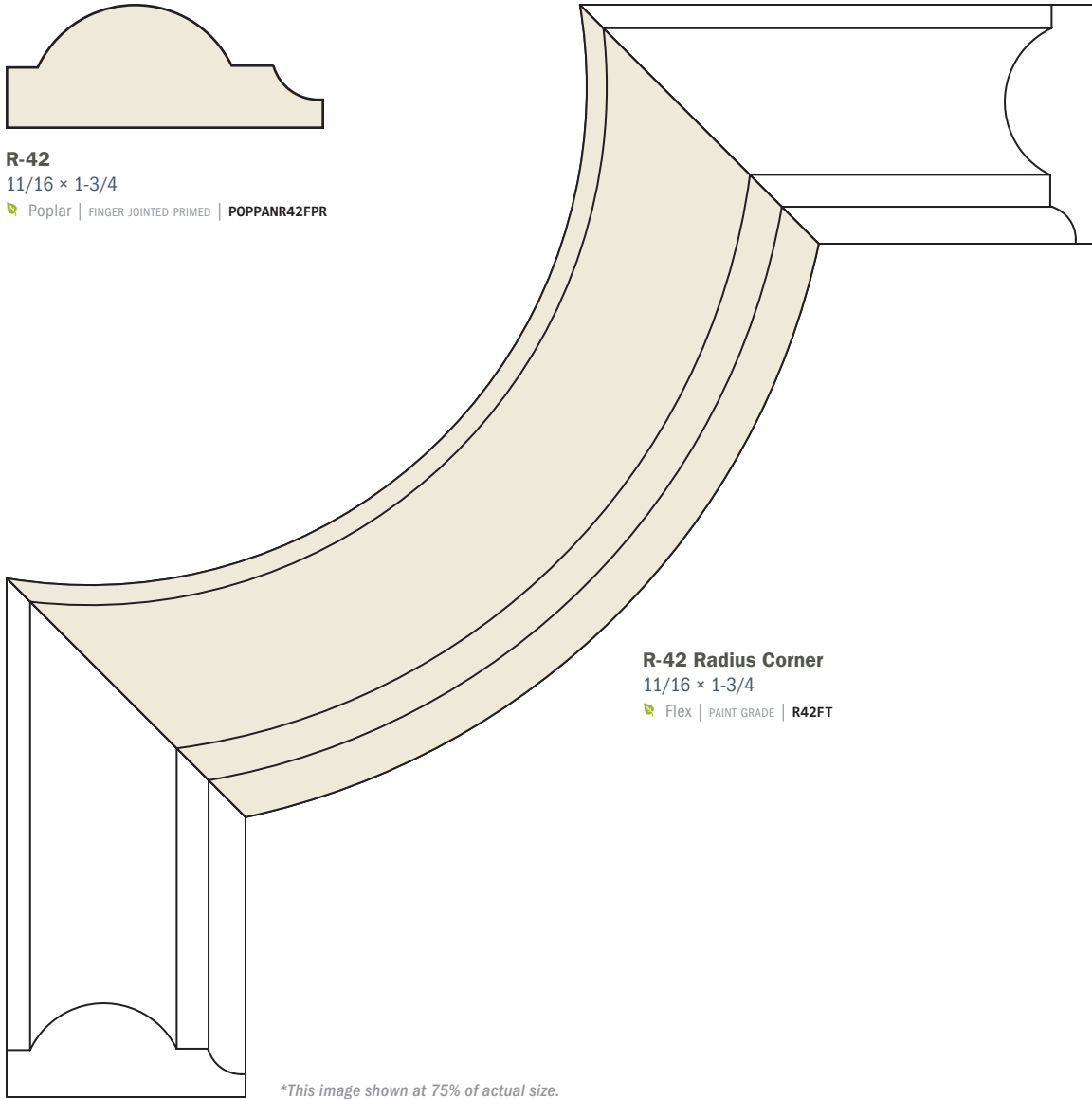

R-42 Radius Corner

11/16 × 1-3/4

Flex | PAINT GRADE | R42FT

**This image shown at 75% of actual size.*

SCALE: Actual Size

CEILINGS AND PANELINGS

Walls & Ceilings

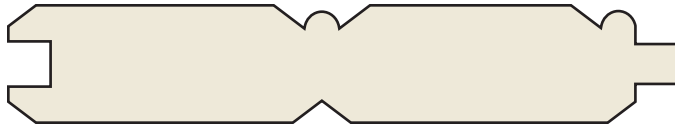

T&G Beaded V-Joint 1 x 4 Ceiling

5/8 x 3-1/2

🌿 Douglas Fir | STAIN GRADE | 14FTGB

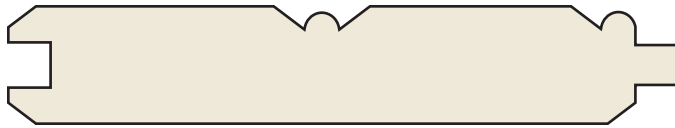

T&G Beaded Flat Back 1 x 4 Ceiling

5/8 x 3-1/2

🌿 Paulownia | FINGER JOINTED PRIMED | 1416PAULBC



Shiplap

3/4 x 5-1/2

🌿 Paulownia | FINGER JOINTED PRIMED | 1616PAULNGLAP

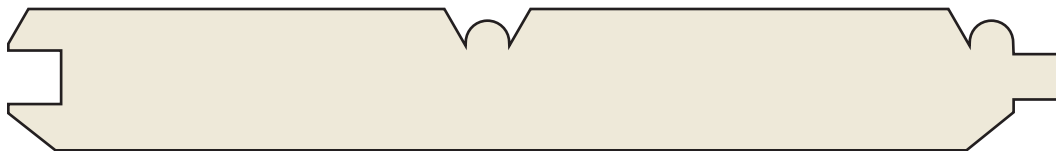

T&G Beaded V-Joint 1 x 6 Ceiling

3/4 x 5-1/2

🌿 Cypress | STAIN GRADE | 16TGBCYP

🌿 Paulownia | FINGER JOINTED PRIMED | 1616PAULVTGP

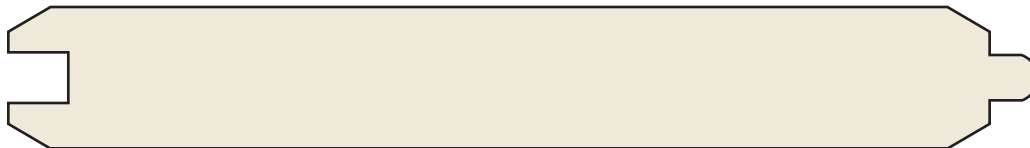

T&G V-Joint 1 x 6

3/4 x 5-1/2

🌿 Cedar | STAIN GRADE | 16WRCWP4

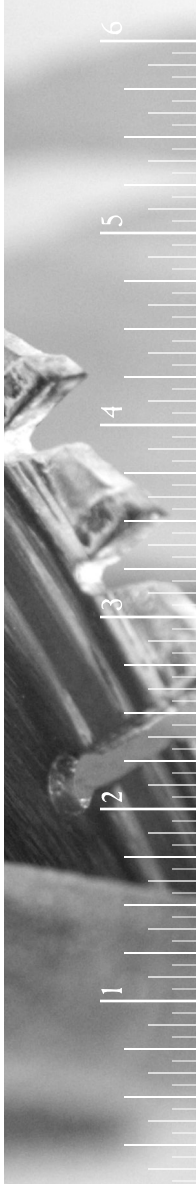

📏 SCALE: Actual Size

CEILING AND PANELINGS

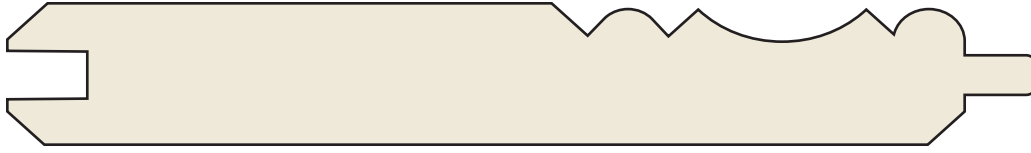

WP2 & WP4 T&G — 1 × 6 | 1 × 8 | 1 × 10

3/4 × 5-3/8 | 7-1/4 | 9-1/4

🌲 Eastern Knotty Pine | STAIN GRADE | 1 × 6 | **168KPWP24**
| 1 × 8 | **188KPWP24**
| 1 × 10 | **110KPWP24**

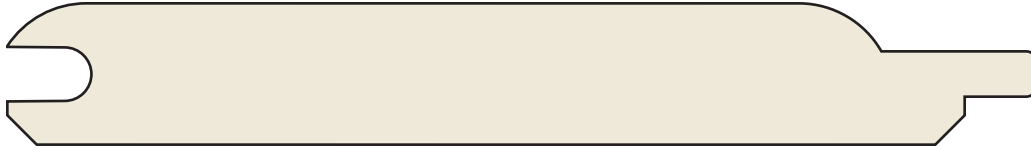

WP6 & WP4 T&G — 1 × 6 | 1 × 8 | 1 × 10

3/4 × 5-3/8 | 7-1/4 | 9-1/4

🌲 Eastern Knotty Pine | STAIN GRADE | 1 × 6 | **168KPWP64**
| 1 × 8 | **188KPWP64**
| 1 × 10 | **110KPWP64**

📏 SCALE: Actual Size

BASEBOARDS

Floors



WM-623 Ogee Base

9/16 × 3-1/4

- Flex | **623FT12**
- Pine | FINGER JOINTED PRIMED | **WM623FP**
- Pine | STAIN GRADE | **WM623S**



WM-663 Ogee Base

9/16 × 3-1/4

- Pine | FINGER JOINTED PRIMED | **WM663P**



WM-713 Ranch Base

9/16 × 3-1/4

- Pine | FINGER JOINTED PRIMED | **WM713P**
- Pine | STAIN GRADE | **WM713S**



WM-753 Beaded Base

9/16 × 3-1/4

- Pine | FINGER JOINTED PRIMED | **WM753P**
- Pine | STAIN GRADE | **WM753S**

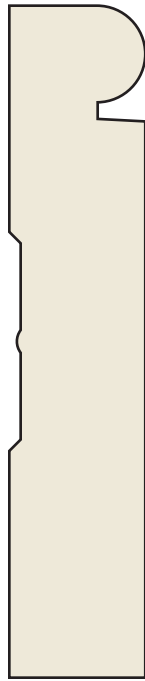

9750M Casing

11/16 × 3-1/2

- MDF | SOLID PRIMED | **9750MDF16**



WM-620 Ogee Base

9/16 × 4-1/4

- Pine | FINGER JOINTED PRIMED | **WM620P**
- Pine | STAIN GRADE | **WM620S**

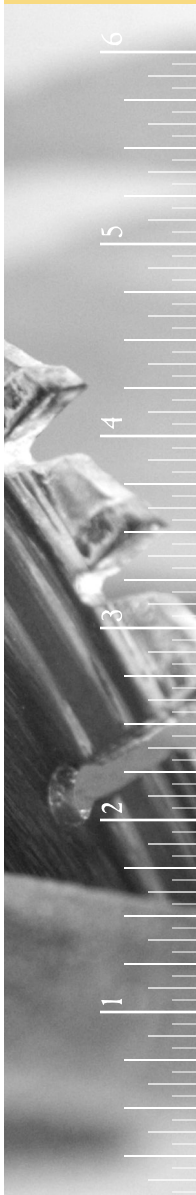

SCALE: Actual Size

BASEBOARDS



WM-750 Beaded Base
9/16 × 4-1/4

Pine | FINGER JOINTED PRIMED | **WM750P**
 Pine | STAIN GRADE | **WM750S**



LWM-752 Beaded Base
9/16 × 5-1/4

Pine | FINGER JOINTED PRIMED | **WM751P**



SM-9910 Base
9/16 × 5-1/4

Poplar | FINGER JOINTED PRIMED |
POPBSM9910FPR



WM-618 Ogee Base
9/16 × 5-1/4

Pine | FINGER JOINTED PRIMED |
WM618P

SCALE: Actual Size

BASEBOARDS

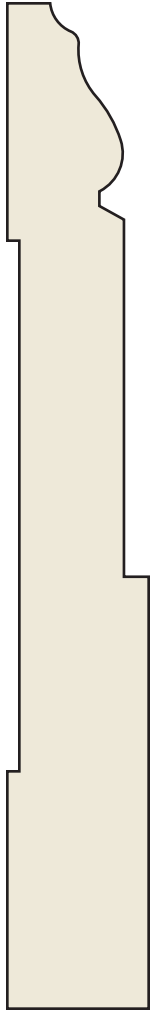

SM-266 Bates' Base
3/4 × 5-1/4

Poplar | FINGER JOINTED PRIMED | **SM266POP**



SM-66 One Piece Ogee Base
11/16 × 5-1/4

Flex | **610FT12**
Pine | FINGER JOINTED PRIMED | **SM66FPR**
Pine | STAIN GRADE | **SM66**



SM-97 Base
13/16 × 5-1/2

Poplar | FINGER JOINTED PRIMED | **POPBSM97FPR**

Floors

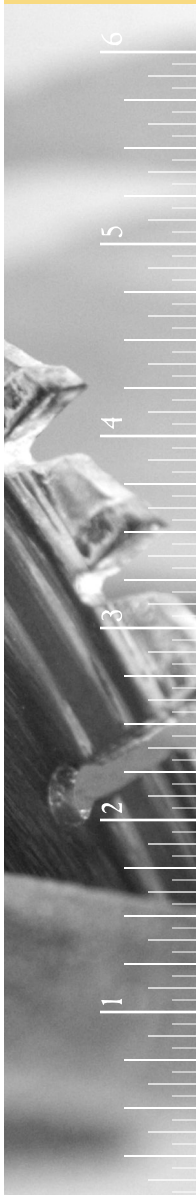

SCALE: Actual Size

BASEBOARDS

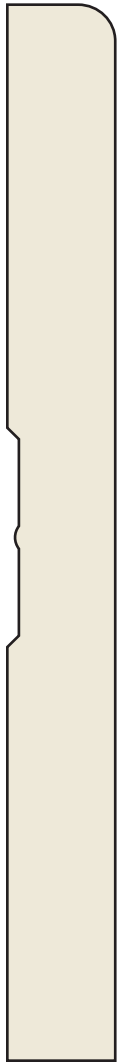

WM-432E
9/16 × 5-1/2

 Pine | FINGER JOINTED PRIMED | **WM432EPE1E**



9263M Base
11/16 × 7-1/16

 MDF | SOLID PRIMED | **MDFB926316PRU**



163E7M Base
9/16 × 7-1/4

 MDF | SOLID PRIMED | **B163MDFUL16**

 SCALE: Actual Size

BASE CAPS

Floors

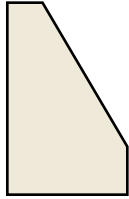

SM-9935

5/8 × 1

Poplar | FINGER JOINTED PRIMED | POPBCSM9935FPR



SM-54

5/8 × 1-3/8

Pine | STAIN GRADE | SM54

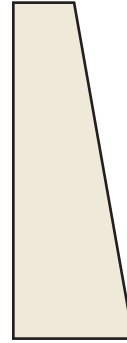

SM-9930

5/8 × 1-3/4

Poplar | FINGER JOINTED PRIMED | POPBCSM9930FPR

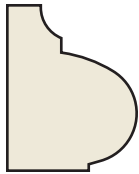

LWP-114

11/16 × 7/8

Pine | STAIN GRADE | LWP114



WM-164 Beveled Ogee

11/16 × 1-1/8

Pine | STAIN GRADE | WM164S



WM-167 Plain Ogee

11/16 × 1-1/8

Pine | FINGER JOINTED PRIMED | WM167P
Pine | STAIN GRADE | WM167S



LWP-113

11/16 × 1-1/4

Pine | STAIN GRADE | WM113S

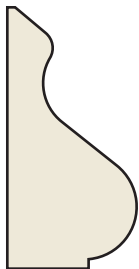

SM-240B Ogee

11/16 × 1-3/8

Oak, Red | STAIN GRADE | SM240B0



WM-163 Beveled Ogee

11/16 × 1-3/8

Flex | 163FT12
Pine | FINGER JOINTED PRIMED | WM163P
Pine | STAIN GRADE | WM163S



WM-165 Plain Ogee

11/16 × 1-3/8

Pine | STAIN GRADE | WM165S





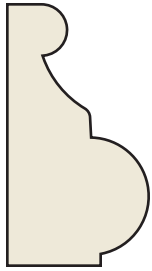

SCALE: Actual Size

BASE CAPS



SM-30 Beaded Ogee

3/4 × 1-3/8

-  Cherry | STAIN GRADE | **SM30CH**
-  Mahogany | STAIN GRADE | **SM30MAH**
-  Maple | STAIN GRADE | **SM30M**
-  Oak, Red | STAIN GRADE | **SM30O**
-  Pine | FINGER JOINTED PRIMED | **SM30BFS**
-  Pine | STAIN GRADE | **SM30**

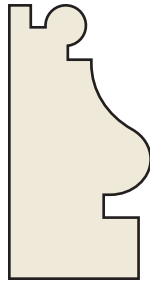

SM-865 Smoot Base Cap

3/4 × 1-7/16

-  Poplar | SOLID PRIMED | **POPBCVSM865PR**

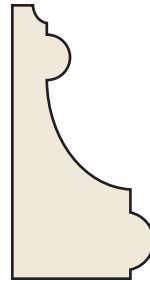

SM-860 Fairfax Base Cap

3/4 × 1-7/16

-  Poplar | SOLID PRIMED | **POPBCVSM860PR**

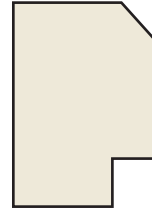

SM-9932

3/4 × 1-1/16

-  Poplar | FINGER JOINTED PRIMED | **POPBCSM9932FPR**



SM-9934

3/4 × 1-1/16

-  Poplar | FINGER JOINTED PRIMED | **POPBCSM9934FPR**

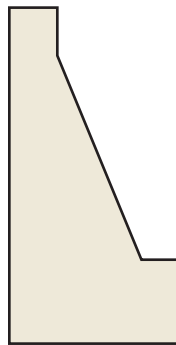

SM-9950

7/8 × 1-3/4

-  Poplar | FINGER JOINTED PRIMED | **POPBCSM9950FPR**



SM-40 Federal Base Cap

7/8 × 1-7/8

-  Poplar | FINGER JOINTED PRIMED | **POPBCSM40FPR**

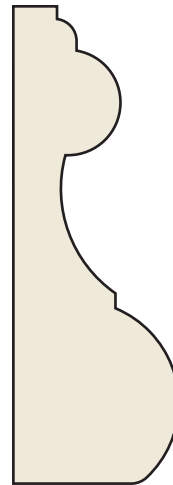

SM-45 Winston

7/8 × 2-1/2

-  Poplar | FINGER JOINTED PRIMED | **POPCHSM45FPR**

 SCALE: Actual Size

BASE CAPS

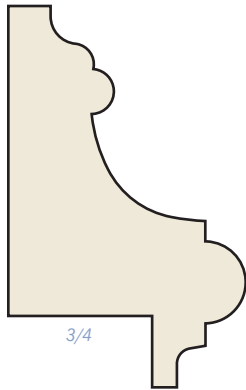

SM-64 Longwood Panel Mould
1-1/4 × 2
Poplar | SOLID PRIMED | POPPANSM64PR

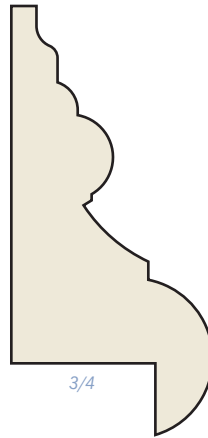

SM-143 Falcon Panel Mould
1-1/16 × 2-1/4
Poplar | FINGER JOINTED PRIMED | POPPANSM143FPR

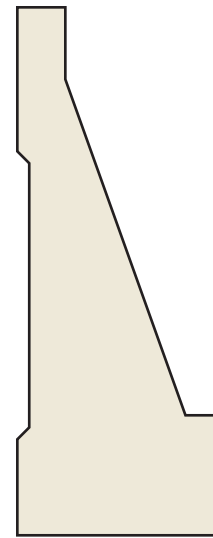

SM-9951
1-1/16 × 2-3/4
Poplar | FINGER JOINTED PRIMED | POPCRSM9951FPR

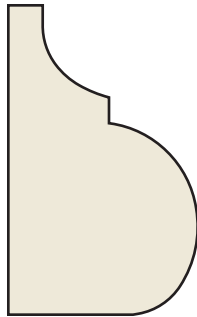

SM-65
1 × 1-5/8
Pine | STAIN GRADE | SM65

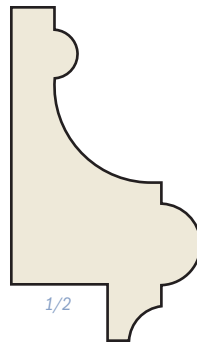

SM-62 Longwood Panel Mould
1 × 1-3/4
Cherry | STAIN GRADE | SM62CH
Maple | STAIN GRADE | SM62M
Oak, Red | STAIN GRADE | SM62O
Pine | STAIN GRADE | SM62
Poplar | FINGER JOINTED PRIMED | POPPANSM62FPR

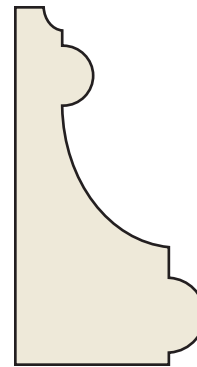

SM-862 Fairfax Base Cap
1 × 1-7/8
Poplar | SOLID PRIMED | POPBCEVSM862PR

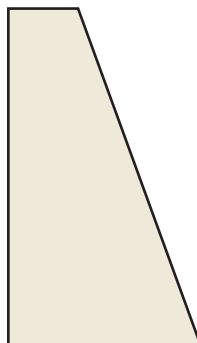

SM-9931
1 × 1-3/4
Poplar | FINGER JOINTED PRIMED | POPBCSM9931FPR

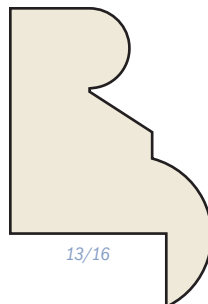

SM-60 Pine Picture Frame Mould
1-1/16 × 1-9/16
Poplar | FINGER JOINTED PRIMED | POPPANSM60FPR

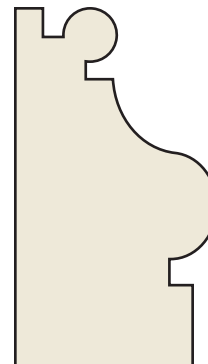

SM-867 Smoot Base Cap
1-1/16 × 1-7/8
Poplar | SOLID PRIMED | POPBCEVSM867PR

SCALE: Actual Size

Flours

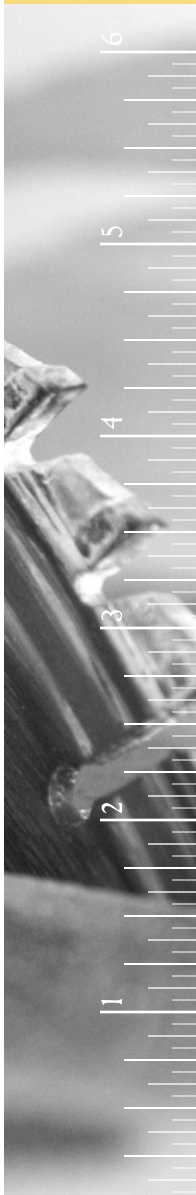

THRESHOLDS AND FLOORINGS

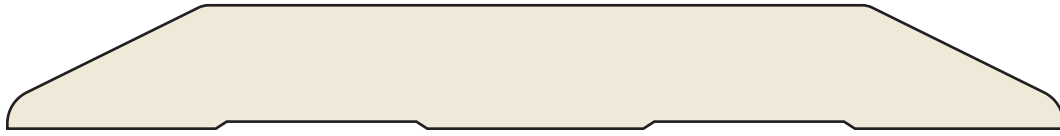

SM-810 Threshold
 5/8 × 5
 Oak, Red | STAIN GRADE | SM8100

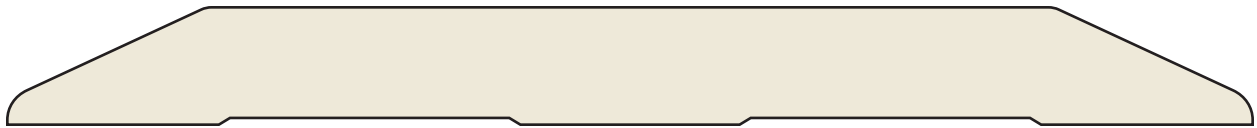

SM-820 Threshold
 5/8 × 6
 Oak, Red | STAIN GRADE | SM8200

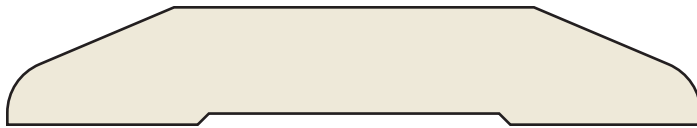

SM-800 Threshold
 5/8 × 3-5/8
 Oak, Red | STAIN GRADE | SM8000

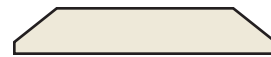

SM-805 Mini Threshold
 1/4 × 1-3/8
 Oak, Red | STAIN GRADE | SM8050

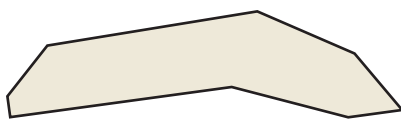

SM-175 Carpet Edge
 1/2 × 2
 Oak, Red | STAIN GRADE | SM1750



SM-171 Reducer Strip
 5/8 × 1-1/2
 Oak, Red | STAIN GRADE | RED40



SM-169 Reducer Strip
 3/4 × 2-1/4
 Oak, Red | STAIN GRADE | RED0

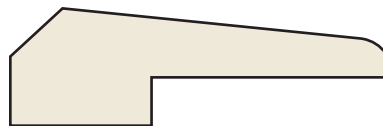

SM-177 Carpet Edge
 5/8 × 2
 Oak, Red | STAIN GRADE | SM1770

SCALE: Actual Size

THRESHOLDS AND FLOORINGS

Floors

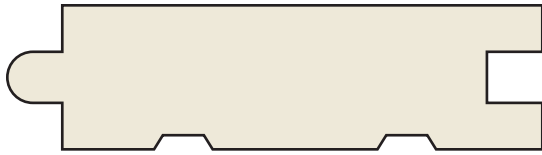

Historic Width
2-1/2 Face
Yellow Pine | 34212SYPTGC

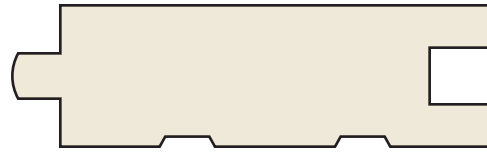

T&G 1 x 3
3/4 x 2-1/2 (2-1/4 Face)
Red Oak | STAIN GRADE | 34ROAKFL

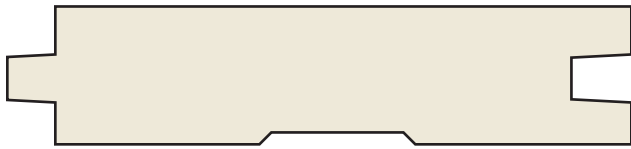

1 x 4
3-1/4 x 23/32 (3 Face)
Treated Pine Primed | 14GTG25

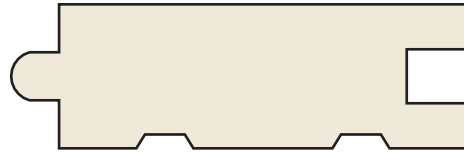

1 x 3
2-1/8 Face
Yellow Pine | 34218SYPTGC



1 x 4
3-1/8 Face
Yellow Pine | 14CTG5YP

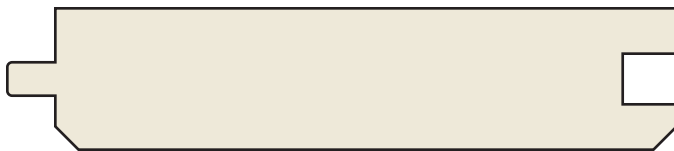

T&G 1 x 4
3/4 x 3-1/2 (3-1/4 Face)
Mahogany | STAIN GRADE | PM14TG



1 x 6
5-1/8 Face
Yellow Pine | 16TGSYPC

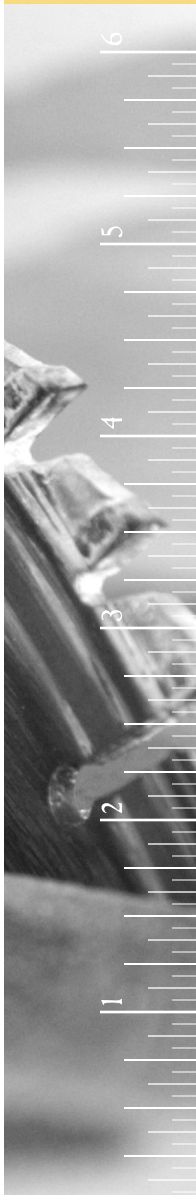

SCALE: Actual Size

SHOES



LWM-131 Ogee Shoe

7/16 × 11/16

🌲 Pine | STAIN GRADE | **WM131S**



SM-200A Sanitary Shoe

7/16 × 11/16

🌲 Oak, Red | STAIN GRADE | **SM200AO**

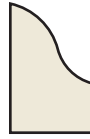

SM-200B Ogee Shoe

7/16 × 11/16

🌲 Oak, Red | STAIN GRADE | **SM200BO**



SM-200C Sanitary Shoe

1/2 × 3/4

🌲 Oak, Red | STAIN GRADE | **SM200CO**
🌲 Pine | STAIN GRADE | **SM200C**



SM-200D Ogee Shoe

9/16 × 13/16

🌲 Oak, Red | STAIN GRADE | **SM200DO**
🌲 Pine | STAIN GRADE | **SM200D**



SM-200G Jumbo Ogee Shoe

3/4 × 1

🌲 Oak, Red | STAIN GRADE | **SM200GO**

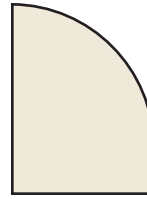

SM-200J Jumbo Shoe

3/4 × 1

🌲 Oak, Red | STAIN GRADE | **SM200JO**
🌲 Pine | STAIN GRADE | **SM200J**



SM-200P

3/8 × 11/16

🌲 Pre-Finished Luan | **SM200P**

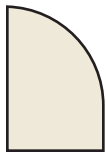

WM-126 Sanitary Shoe

1/2 × 3/4

🌲 Flex | **126FT12**
🌲 Pine | FINGER JOINTED PRIMED | **WM126P**



WM-129 Sanitary Shoe

7/16 × 11/16

🌲 Pine | FINGER JOINTED PRIMED | **WM129P**
🌲 Pine | STAIN GRADE | **WM129S**



SM-9932

3/4 × 1-1/16

🌲 Poplar | FINGER JOINTED PRIMED | **POPBCSM9932FPR**



SM-9934

3/4 × 1-1/16

🌲 Poplar | FINGER JOINTED PRIMED | **POPBCSM9934FPR**

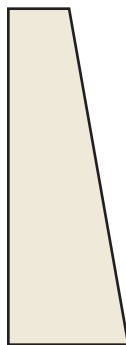

SM-9930

5/8 × 1-3/4

🌲 Poplar | FINGER JOINTED PRIMED | **POPBCSM9930FPR**



SM-9935

5/8 × 1

🌲 Poplar | FINGER JOINTED PRIMED | **POPBCSM9935FPR**

📏 SCALE: Actual Size

BAR RAILS

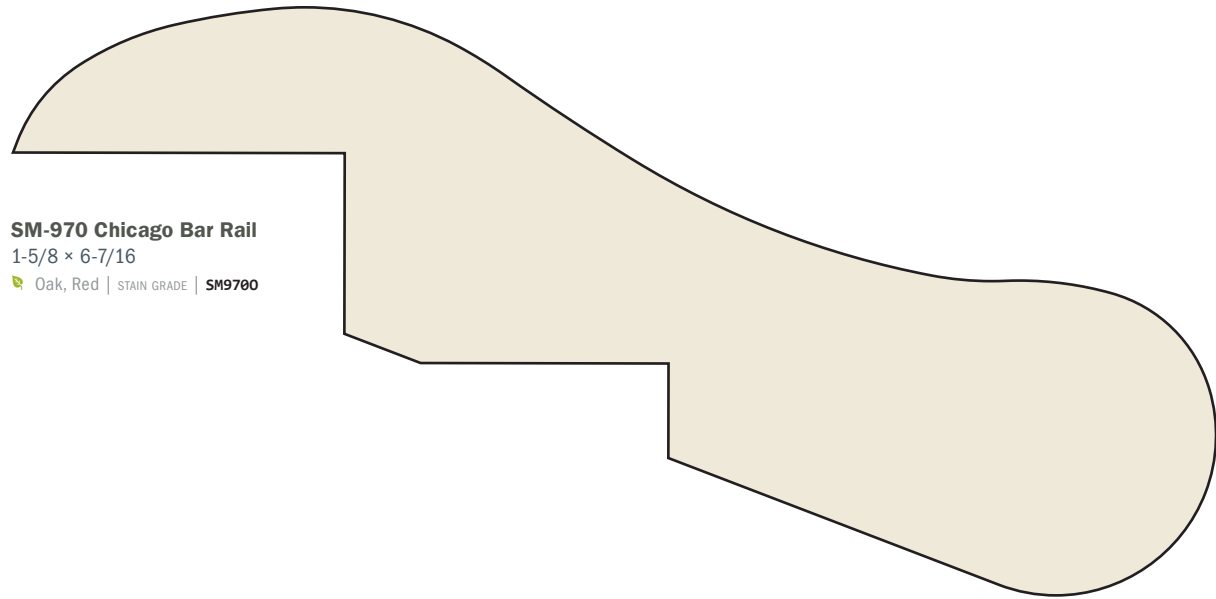

SM-970 Chicago Bar Rail
1-5/8 × 6-7/16
Oak, Red | STAIN GRADE | SM9700

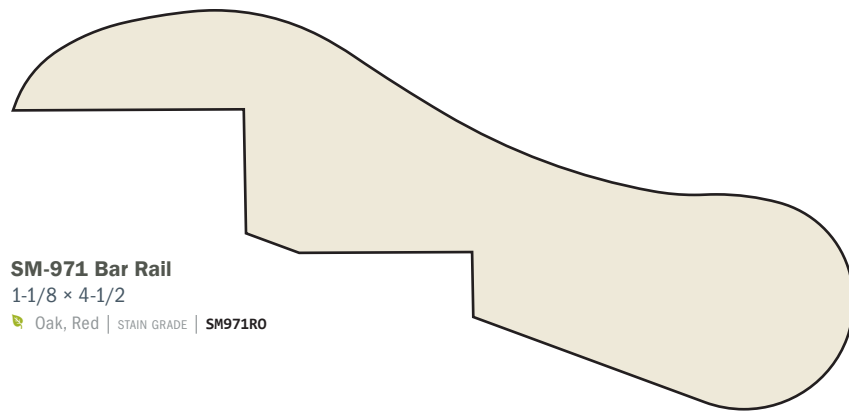

SM-971 Bar Rail
1-1/8 × 4-1/2
Oak, Red | STAIN GRADE | SM971R0

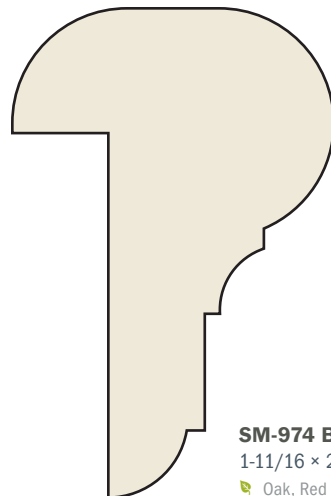

SM-974 Bar Rail
1-11/16 × 2-9/16
Oak, Red | STAIN GRADE | SM9740

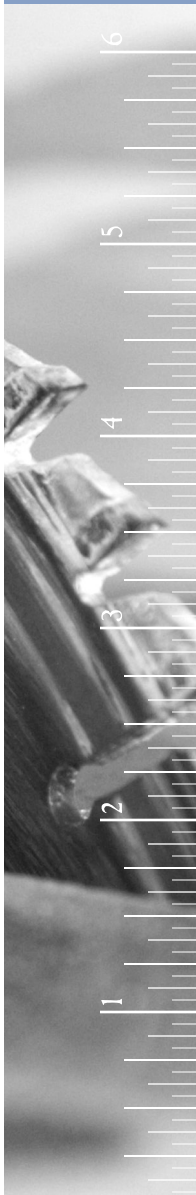

SCALE: Actual Size

DENTILS

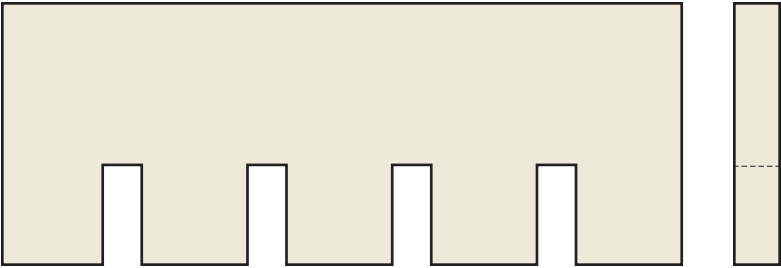

SM-33 Dentil
1/4 × 1-3/8
Pine | STAIN GRADE | SM33

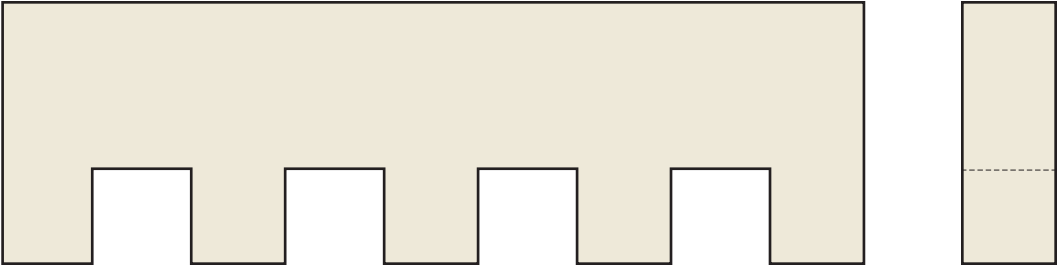

SM-34 Dentil
1/2 × 1-3/8
Pine | STAIN GRADE | SM34

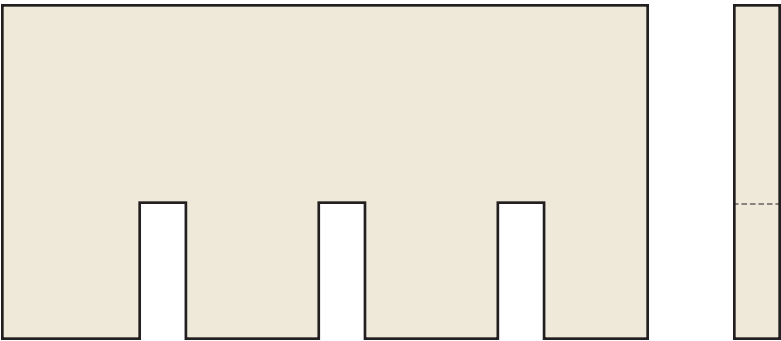

SM-35 Dentil
1/4 × 1-3/4
Pine | STAIN GRADE | SM35

SCALE: Actual Size

DENTILS

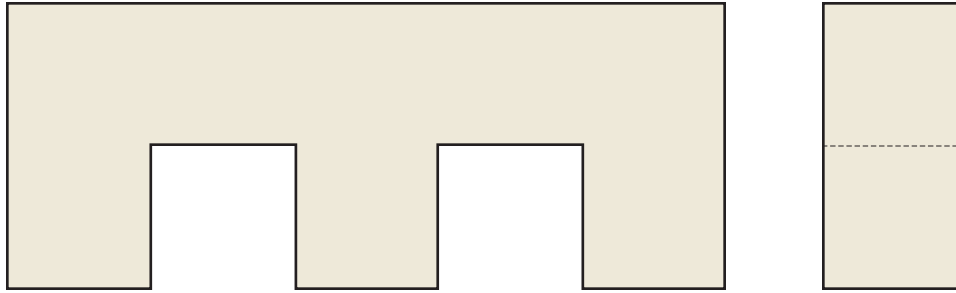

SM-36 Dentil

3/4 × 1-1/2

Pine | STAIN GRADE | SM36

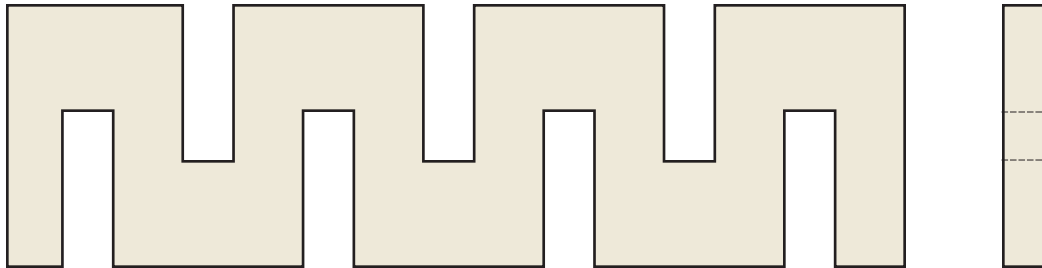

SM-37 Dentil

1/4 × 1-3/8

Pine | STAIN GRADE | SM37

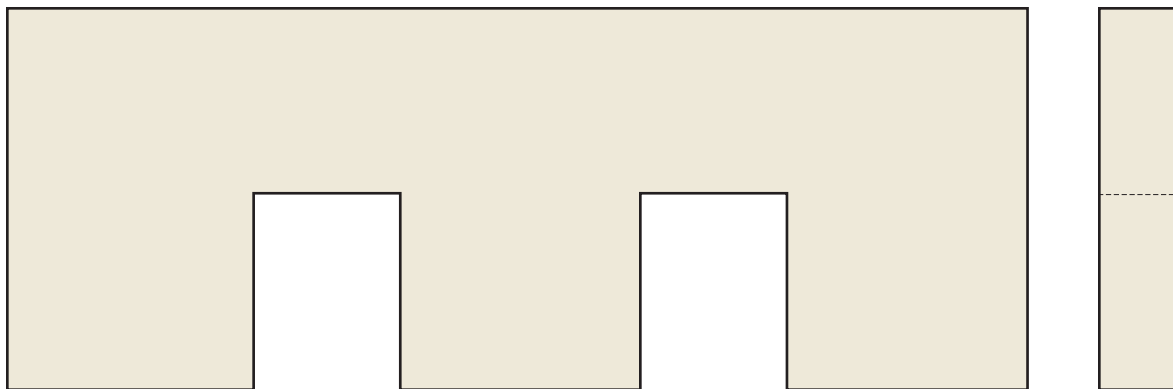

SM-39 Dentil

7/16 × 2

Pine | STAIN GRADE | SM39

SCALE: Actual Size

DOOR JAMBS

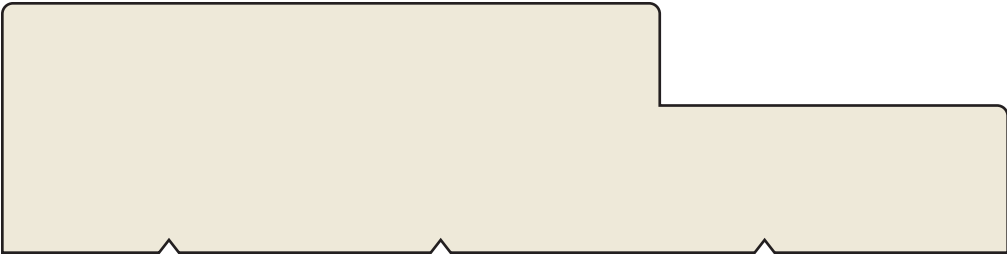

Single Rabbeted Exterior Jamb

1-5/16 × 5-1/4

Eastern White Pine | STAIN GRADE | EFR68514



Flat Interior Jamb

11/16 × 4-9/16

Pine | FINGER JOINTED PRIMED | 4916FJSPR



Flat Interior Jamb

11/16 × 6-9/16

Pine | FINGER JOINTED PRIMED | 6916FJH

SCALE: Actual Size

GLAZINGS AND LATTICES



LWM-254 Parting Bead
7/16 × 11/16
Pine | STAIN GRADE | WM254S



LWM-265 Lattice
1/4 × 1-3/4
Pine | STAIN GRADE | WM265S



LWM-267 Lattice
1/4 × 1-3/8
Pine | STAIN GRADE | WM267S



LWM-268 Lattice
1/4 × 1-1/8
Pine | STAIN GRADE | WM268S



LWM-269 Lattice
1/4 × 1-1/2
Pine | STAIN GRADE | LWM269S



SM-500D Lattice
1/4 × 2
Oak, Red | STAIN GRADE | SM500DO



LWM-953 Bullnose Stop
7/16 × 1-1/8
Pine | STAIN GRADE | WM953S



LWM-954P Sash Bead
7/16 × 1-3/8
Pine | FINGER JOINTED PRIMED | WM954P



SM-50 Bullnose Stop
1/2 × 2-1/4
Pine | FINGER JOINTED PRIMED | SM50FPR



SM-58 Panel
1/2 × 5/8
Pine | STAIN GRADE | SM58



WM-142 Plain Screen Bead
1/4 × 3/4
Pine | STAIN GRADE | WM142S



WM-144 Beaded Screen Bead
1/4 × 3/4
Pine | STAIN GRADE | WM144S



WM-147 Glass Bead
1/2 × 9/16
Pine | STAIN GRADE | WM147S



LWP-150 Glass Bead
5/8 × 3/4
Pine | STAIN GRADE | GBL150



SM-52 Bullnose Stop
3/4 × 1-1/8
Pine | STAIN GRADE | SM52

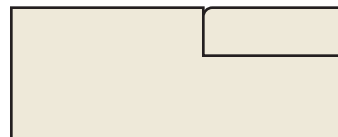

SM-71 Screening Stock
11/16 × 1-3/4
Pine | STAIN GRADE | SM71P



SM-69 Muntin Bar
9/16 × 1-3/8
Pine | STAIN GRADE | SM69

SCALE: Actual Size

ROUNDS

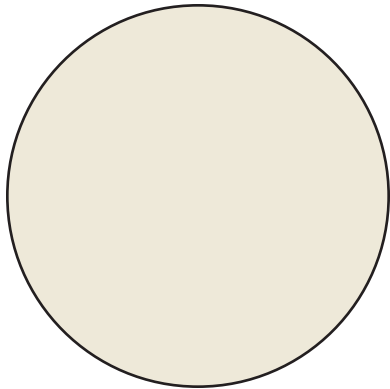

SM-922 Full Round

2 × 2

Oak, Red | STAIN GRADE | 60390

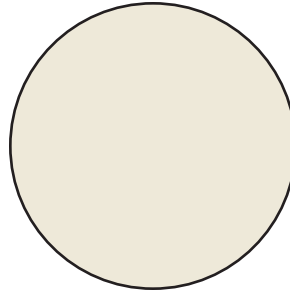

LWM-232 Full Round

1-1/2 × 1-1/2

Fir | STAIN GRADE | FRND112

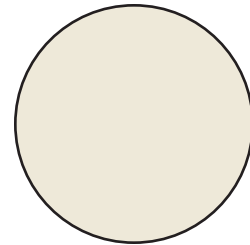

LWM-233 Full Round

1-1/4 × 1-1/4

Fir | STAIN GRADE | WM233SF

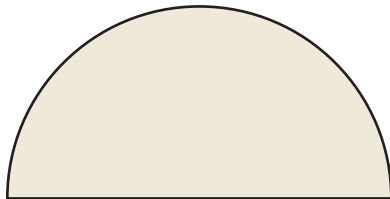

SM-91 Half Round

1 × 2

Poplar | FINGER JOINTED PRIMED | POPHRSM91FPR

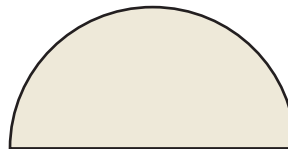

SM-942 Half Round

3/4 × 1-1/2

Oak, Red | STAIN GRADE | WM1160



WM-116 Half Round

11/16 × 1-1/2

Pine | FINGER JOINTED PRIMED | WM116S



WM-120 Half Round

1/2 × 1

Pine | STAIN GRADE | WM120S



WM-122 Half Round

3/8 × 11/16

Pine | STAIN GRADE | WM122S



WM-124 Half Round

1/4 × 1/2

Pine | STAIN GRADE | WM124S

SCALE: Actual Size

ROUNDS

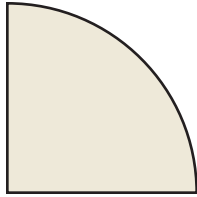

SM-94 Quarter Round
1 × 1

Poplar | FINGER JOINTED PRIMED | POPQRSM94FPR

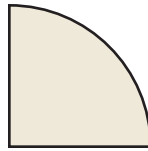

SM-661 Quarter Round
3/4 × 3/4

Cherry | STAIN GRADE | SM661CH
Maple | STAIN GRADE | SM661M
Oak, Red | STAIN GRADE | SM661O

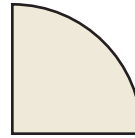

WM-106 Quarter Round
11/16 × 11/16

Pine | FINGER JOINTED PRIMED | WM106P
Pine | STAIN GRADE | WM106S



SM-662 Quarter Round
1/2 × 1/2

Oak, Red | STAIN GRADE | F662O

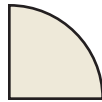

WM-108 Quarter Round
1/2 × 1/2

Pine | STAIN GRADE | WM108S



SM-663 Quarter Round
1/4 × 1/4

Oak, Red | STAIN GRADE | SM663O



WM-110 Quarter Round
1/4 × 1/4

Pine | STAIN GRADE | WM110S

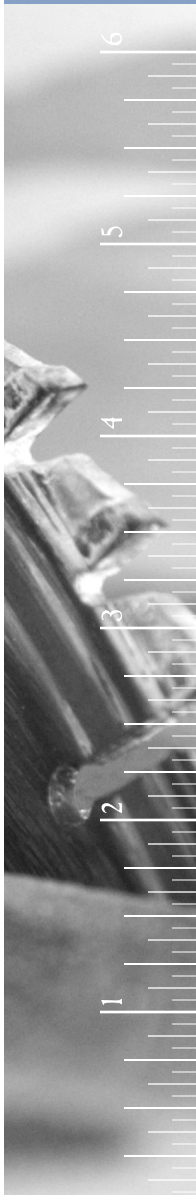

SCALE: Actual Size

MULLIONS AND ASTRAGALS

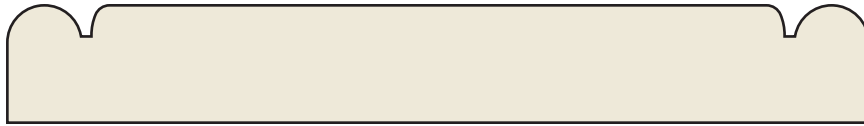

LWM-304 Mullion

5/8 × 4-1/2

🌿 Pine | FINGER JOINTED PRIMED | WM304HP

🌿 Pine | STAIN GRADE | WM304S

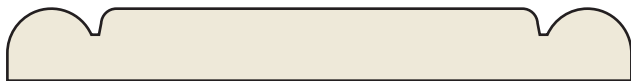

ML-958 Mullion

3/8 × 3-1/4

🌿 Pine | STAIN GRADE | LWM956S



WM-956 Mullion

3/8 × 2

🌿 Pine | STAIN GRADE | WM956S



ML-956 Mullion

3/8 × 1-1/8

🌿 Pine | STAIN GRADE | WM956S118



LWM-956 Mullion

3/8 × 1-1/2

🌿 Pine | STAIN GRADE | ML956

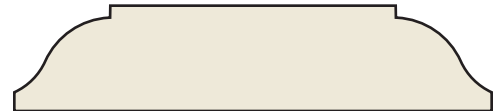

LWM-224

9/16 × 2-1/2

🌿 Pine | STAIN GRADE | WM224S

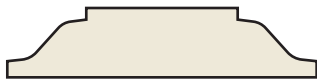

LWM-983 Flat Astragal

3/8 × 1-5/8

🌿 Pine | STAIN GRADE | WM983SSD



SM-63 Clover Mullion

9/16 × 1-1/4

🌿 Pine | STAIN GRADE | SM63



WM-134 Flat Astragal

11/16 × 1-3/8

🌿 Pine | STAIN GRADE | WM134S

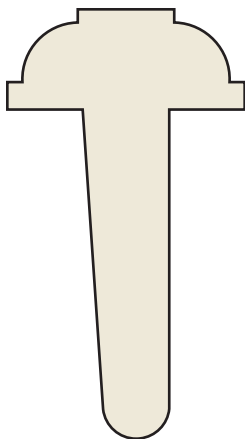

WM-1300 Astragal for 1-3/4 Doors

1-1/4 × 2-1/4

🌿 Pine | STAIN GRADE | WM1300S

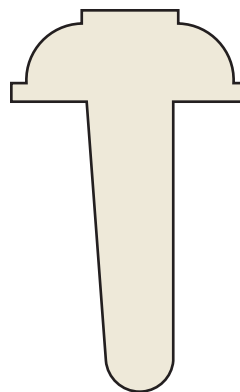

WM-1305 Astragal for 1-3/8 Doors

1-1/4 × 2

🌿 Pine | STAIN GRADE | WM1305S

📏 SCALE: Actual Size

RAILINGS AND STAIRS

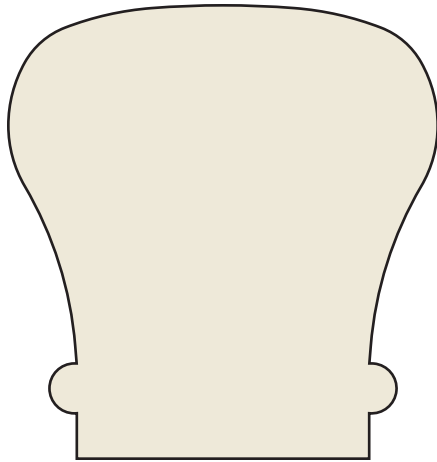

6010 Handrail

2-1/4 × 2-3/8

- Oak | STAIN GRADE | 8' | **6010080SC**
- Oak | STAIN GRADE | 10' | **6010100SC**
- Oak | STAIN GRADE | 12' | **6010120SC**
- Oak | STAIN GRADE | 14' | **6010140SC**
- Oak | STAIN GRADE | 16' | **6010160SC**

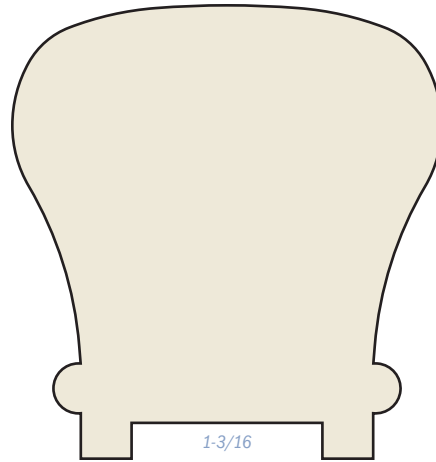

6010 Plowed Handrail

2-1/4 × 2-3/8

- Oak | STAIN GRADE | 8' | **6010P/6050080SC**
- Oak | STAIN GRADE | 10' | **6010P/6050100SC**
- Oak | STAIN GRADE | 12' | **6010P/6050120SC**
- Oak | STAIN GRADE | 14' | **6010P/6050140SC**
- Oak | STAIN GRADE | 16' | **6010P/6050160SC**

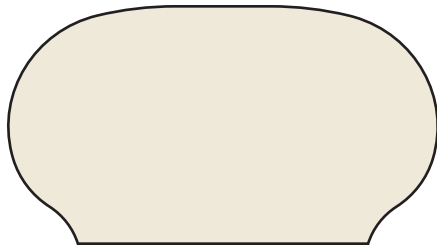

SM-904 Oval Handrail

1-1/4 × 2-1/4

- Oak, Red | STAIN GRADE | **60420**

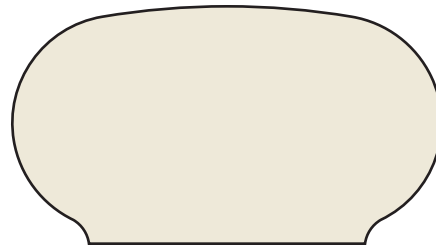

WM-240 Oval Handrail

1-1/4 × 2-1/4

- Fir | **WM240SF**

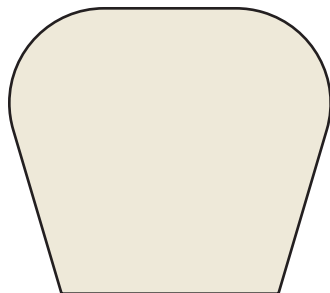

WM-230 Small Handrail

1-1/2 × 1-11/16

- Fir | **WM230S**

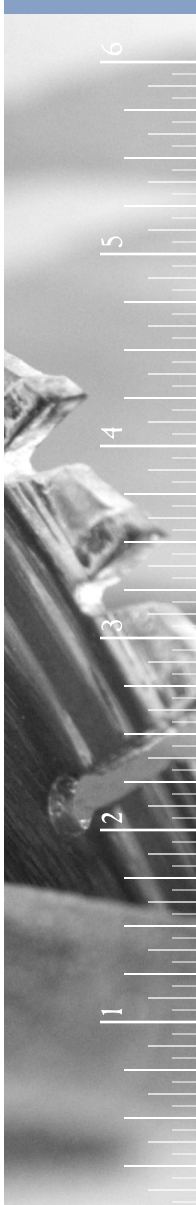

SCALE: Actual Size

RAILINGS AND STAIRS

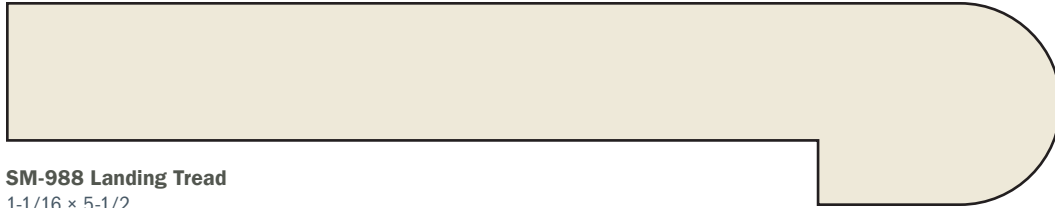

SM-988 Landing Tread

1-1/16 × 5-1/2

🌿 Oak, Red | STAIN GRADE | **F9880**

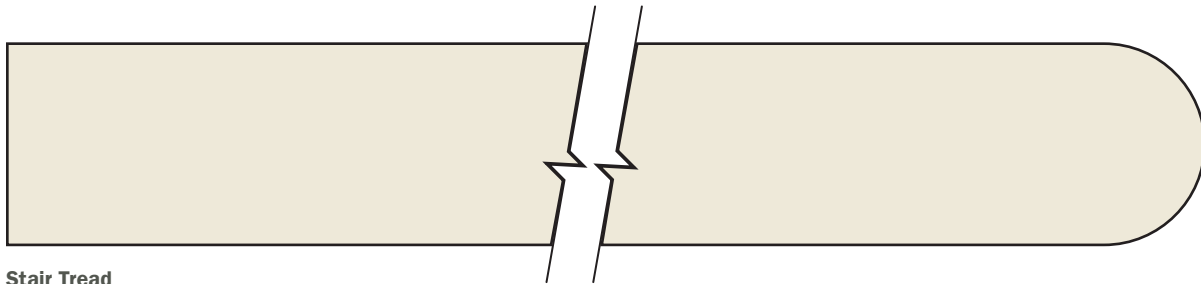

Stair Tread

🌿 Oak, Red | 1-1/16 × 11-1/2 × 36 | **8070036**

🌿 Oak, Red | 1-1/16 × 11-1/2 × 48 | **8070048**

🌿 Oak, Red | 1-1/16 × 11-1/2 × 60 | **8070060**

🌿 Oak, Red | 1-1/16 × 11-1/2 × 72 | **8070072**

🌿 Southern Yellow Pine | 1-1/16 × 11-1/4 | **5412YPCS**

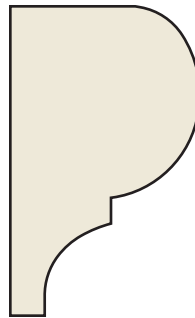

SM-65 Nose and Scotia

1 × 1-5/8

🌿 Pine | STAIN GRADE | **SM65**

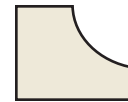

SM-165 Scotia

1/2 × 5/8

🌿 Oak | STAIN GRADE | **WM10750**

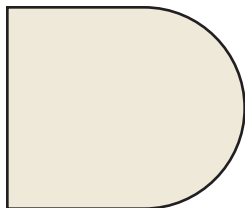

SM-830 Nosing

1-1/16 × 1-1/4

🌿 Oak, Red | STAIN GRADE | **SM8300**

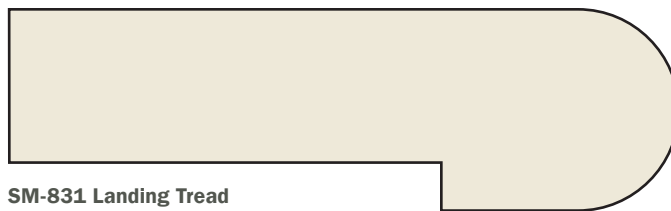

SM-831 Landing Tread

1-1/16 × 3-1/2

🌿 Oak, Red | STAIN GRADE | **80900**

🌿 Pine | STAIN GRADE | **AH8090**

📏 SCALE: Actual Size

RAILINGS AND STAIRS

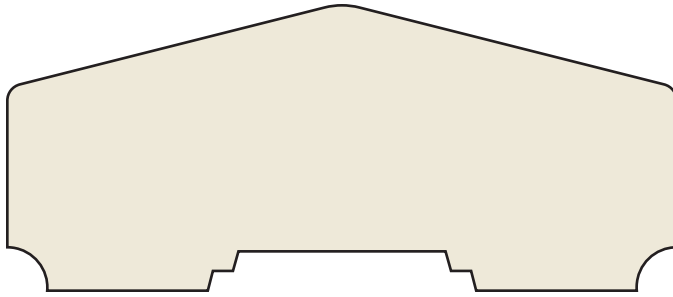

SM-8840 Top Porch Rail
1-1/2 × 3-1/2
Pine | SOLID PRIMED | WM8840P

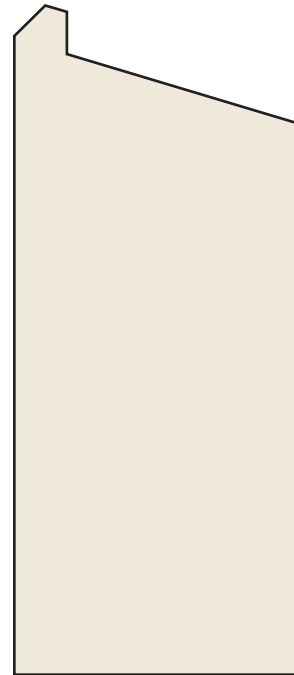

SM-8841 Bottom Porch Rail
1-1/2 × 3-1/2
Pine | SOLID PRIMED | WM8841P

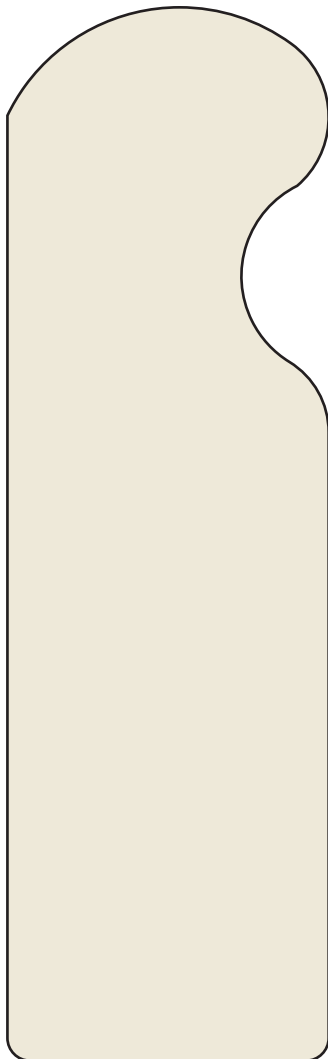

SM-956 Worked Handrail
1-11/16 × 5-1/2
Oak, Red (SM-956-0) | SM956P

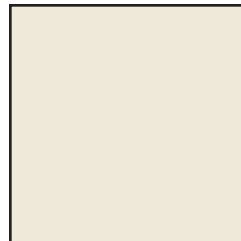

LWM-237 Baluster Stock
1-1/4 × 1-1/4
Pine | SOLID PRIMED | LWM237P



LWM-238 Baluster Stock
1 × 1
Fir | SOLID STAIN | WM238

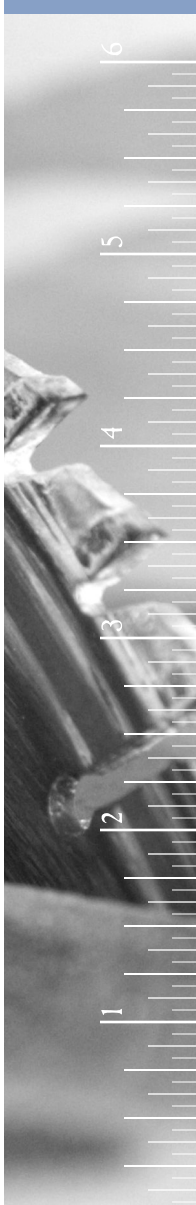

SCALE: Actual Size

S4S | SPECIES AND SIZES MAY VARY

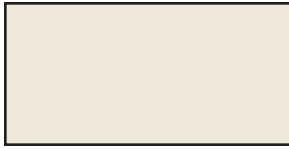

1 x 2
3/4 x 1-1/2

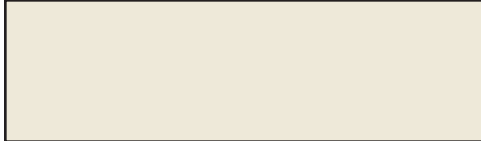

1 x 3
3/4 x 2-1/2

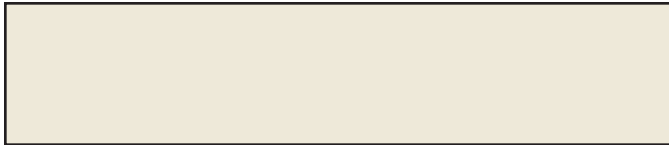

1 x 4
3/4 x 3-1/2

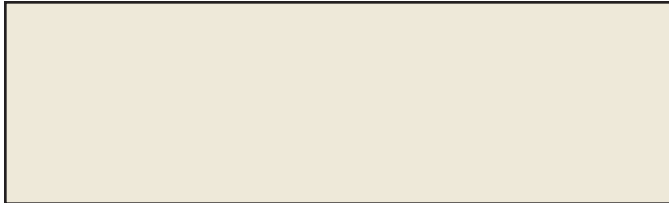



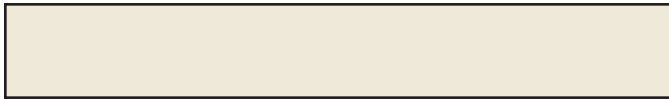









5/4 x 4
1-1/16 x 3-1/2



1/2 x 3-1/2
1/2 x 3-1/2



1/2 x 5-1/2
1/2 x 5-1/2

-  Cherry | STAIN GRADE
-  Cypress | STAIN GRADE
-  Flex
-  Mahogany | STAIN GRADE
-  Maple | STAIN GRADE
-  Oak, Red | STAIN GRADE
-  Oak, White | STAIN GRADE
-  Pine, Eastern White | STAIN GRADE
-  Pine | FINGER JOINTED PRIMED
-  Pine | STAIN GRADE
-  Poplar | PAINT GRADE
-  PVC
-  Teak | STAIN GRADE
-  Walnut | STAIN GRADE

 SCALE: Actual Size

S4S



1 x 6
3/4 x 5-1/2

**This image shown at 50% of actual size.*

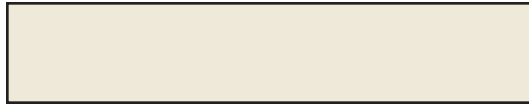

5/4 x 6
1-1/16 x 5-1/2

**This image shown at 50% of actual size.*

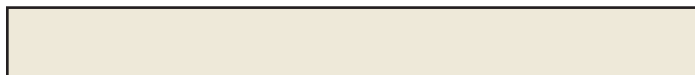

1 x 8
3/4 x 7-1/4

**This image shown at 50% of actual size.*



5/4 x 8
1-1/16 x 7-1/4

**This image shown at 50% of actual size.*



1 x 10
3/4 x 9-1/4

**This image shown at 50% of actual size.*

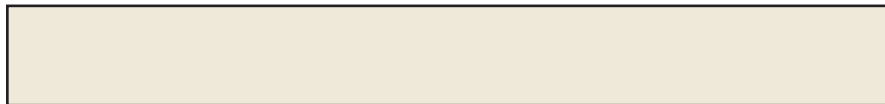

5/4 x 10
1-1/16 x 9-1/4

**This image shown at 50% of actual size.*

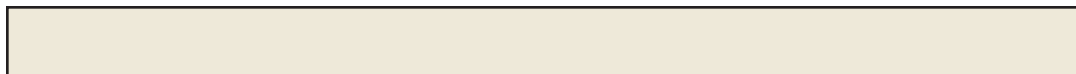

1 x 12
3/4 x 11-1/4

**This image shown at 50% of actual size.*

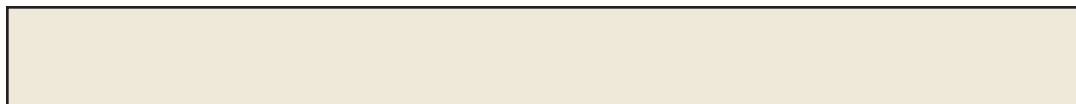

5/4 x 12
1-1/16 x 11-1/4

**This image shown at 50% of actual size.*

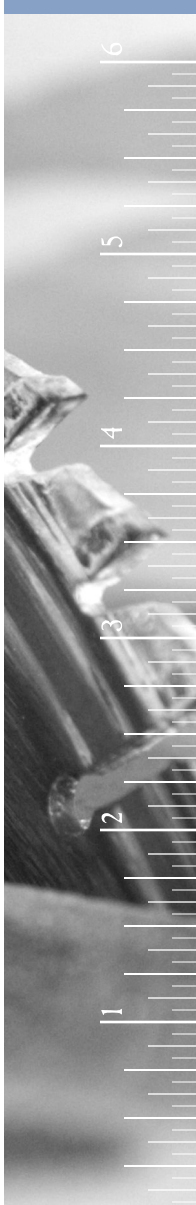



📍 SCALE: Actual Size

RAKES

Expertise

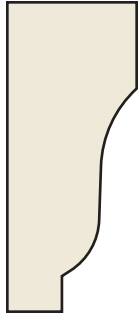

LWM-210
1-1/16 × 1-5/8

Pine | FINGER JOINTED PRIMED | WM210P



SM-44
3/4 × 1-5/8

Cypress | STAIN GRADE | SM44



LWP-286
1-1/16 × 2

Pine | FINGER JOINTED PRIMED | WM286P

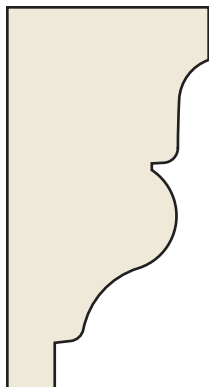

SM-41
1-1/16 × 2

Pine | FINGER JOINTED PRIMED | SM41FPR

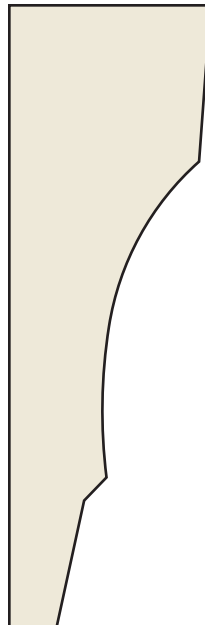

WP-207
1-1/16 × 3-1/2

Pine | STAIN GRADE | WM207S

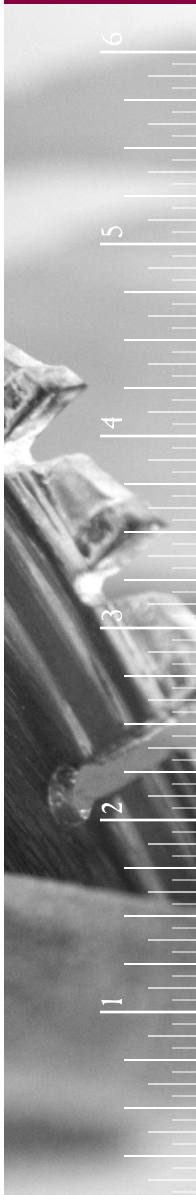

SCALE: Actual Size

BRICKMOULDS AND DRIP CAPS



WM-175 Bullnose Brickmould

1-1/16 × 2

 Pine | FINGER JOINTED PRIMED | **WM175P**

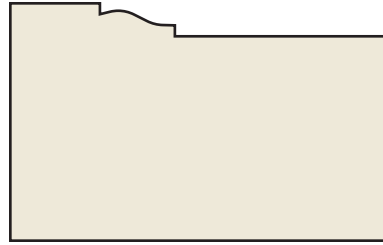

WM-180

1-1/4 × 2

 Flex 2/0 | **180FT20HR**
 Flex 3/0 | **180FT30HR**
 Flex 4/0 | **180FT40HR**
 Flex 6/0 | **180FT60HR**
 Pine | FINGER JOINTED PRIMED | **WM180P**

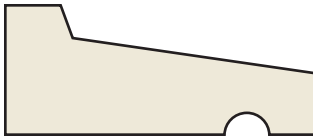

WM-197 Drip Cap

11/16 × 1-5/8

 Pine | FINGER JOINTED PRIMED | **WM197P**

 SCALE: Actual Size

SIDINGS

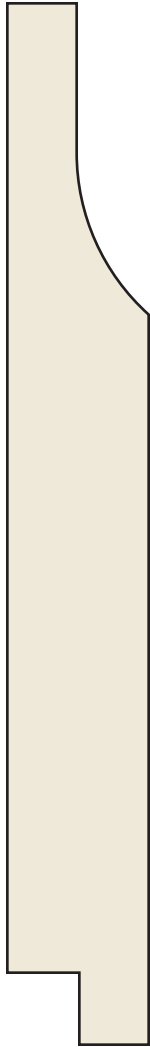

WP-105 German Yellow Pine Siding
3/4 × 5-1/2
Yellow Pine | STAIN GRADE | **16YPC105**

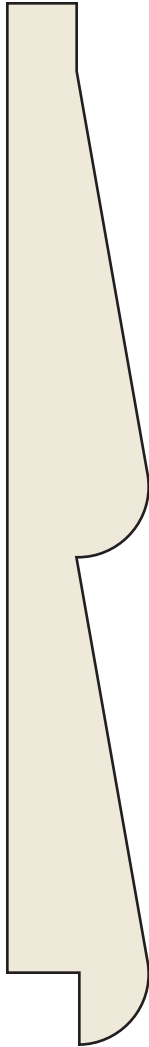

WP-117 Double Worked Yellow Pine Siding
3/4 × 5-1/2
Yellow Pine | STAIN GRADE | **16YPD117**



Beveled Siding
3/4 × 5-1/2
Cypress | STAIN GRADE | **36BVC**

Exterior

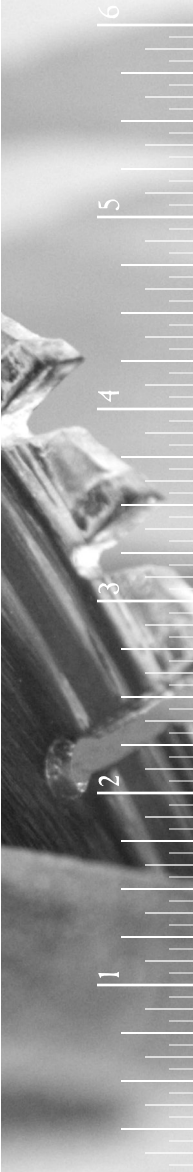

SCALE: Actual Size

SIDINGS

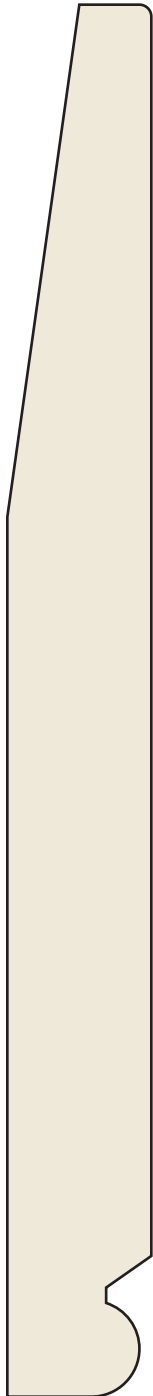

Beaded Beveled Siding

3/4 × 7-1/4

- Cypress | SOLID PRIMED | 348BDBVCP
- Cypress | STAIN GRADE | 348BDBVC

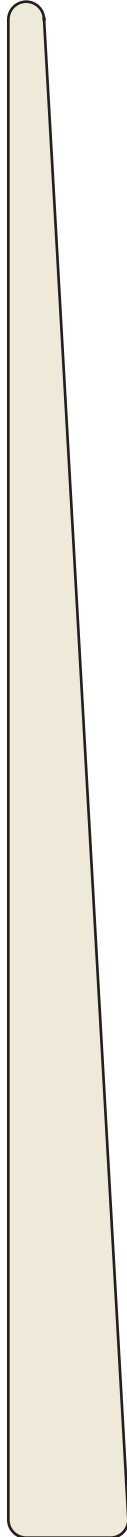

Siding

5/8 × 8

- Cedar | FINGER JOINTED PRIMED | 588WRCBS



Siding

1/2 × 8

- Cedar | FINGER JOINTED PRIMED | CBFJ1208

SCALE: Actual Size

PVC TRIM

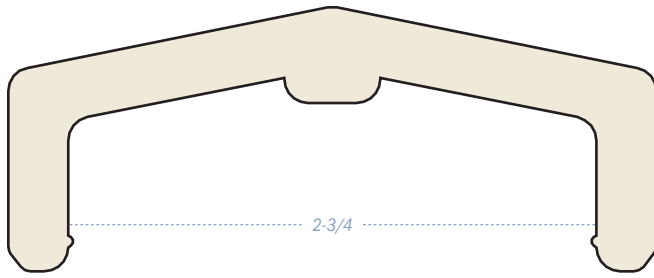

PVC-8840 Rail

1-3/8 × 3-3/8

- 🌿 PVC | 6' | PR8840PVC6
- | 8' | PR8840PVC8
- | 10' | PR8840PVC10

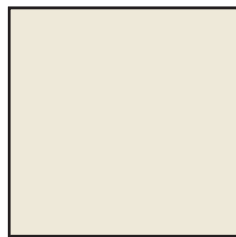

PVC-237 Baluster

1-1/4 × 1-1/4

- 🌿 PVC | PVCBAL237

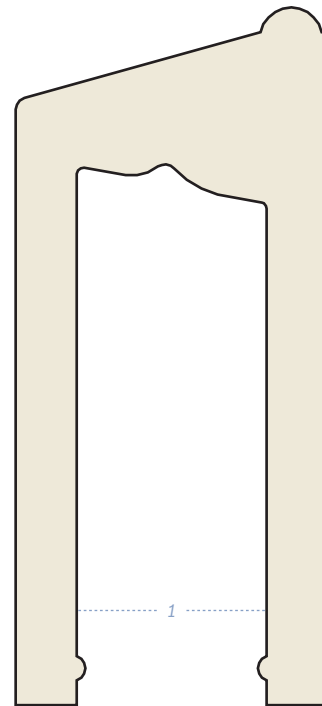

PVC-8841 Rail

1-5/8 × 3-9/16

- 🌿 PVC | 6' | PR8841PVC6
- | 8' | PR8841PVC8
- | 10' | PR8841PVC10

Exterior

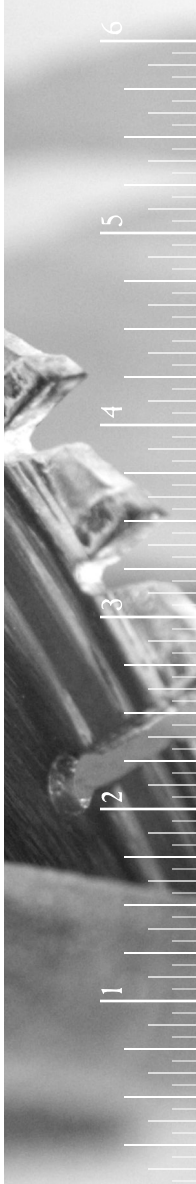

📏 SCALE: Actual Size

PVC TRIM

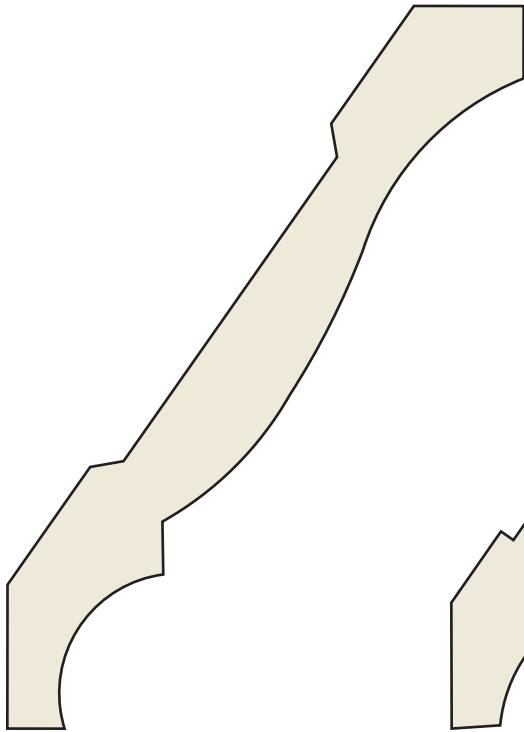

Crown #47
11/16 × 4-5/8
PVC | WM47PVC16

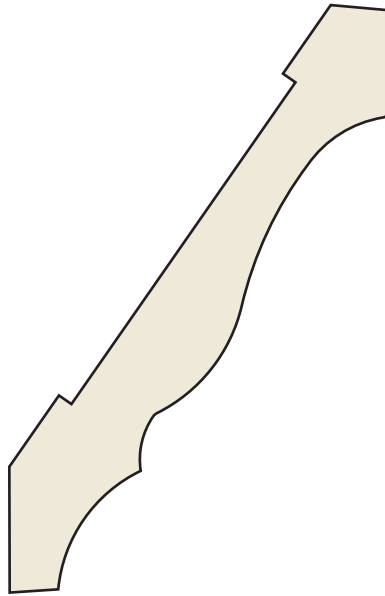

Crown #49
9/16 × 3-5/8
PVC | WM49PVC16

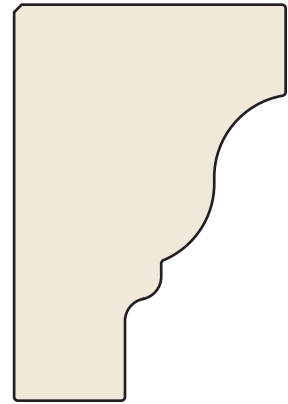

Rams Crown #68
1-13/32 × 2-1/16
PVC | 11332216PVCPRC



Base Cap #164
11/16 × 1-1/8
PVC | WM164PVC16

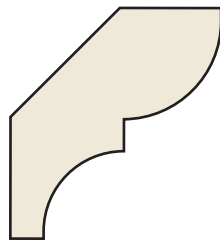

Bed Mould #75
9/16 × 1-5/8
PVC | WM75PVC16

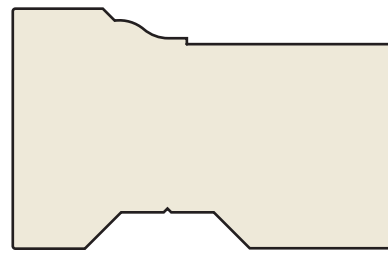

Brickmould #180
1-1/4 × 2
PVC | PVCWM18018

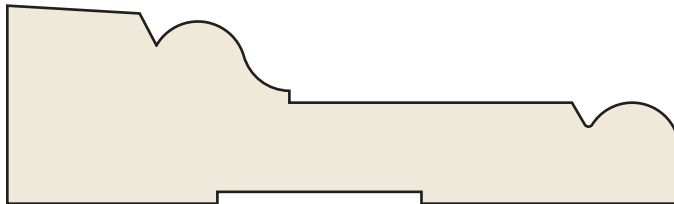

PVC-97 Adams Casing
1-1/32 × 3-1/2
PVC | WM97PVC16

SCALE: Actual Size

PVC TRIM

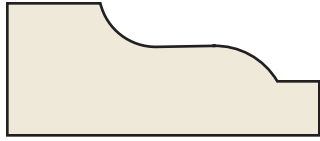

Rake #210
11/16 × 1-5/8
PVC | PVCWM21016

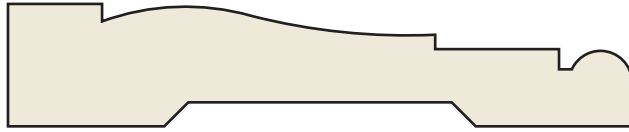

Casing #445
11/16 × 3-1/4
PVC | PVCWM44516

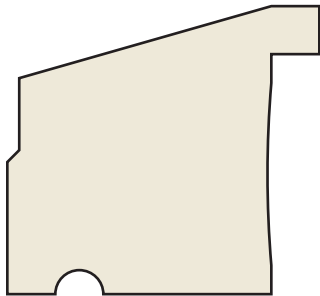

Transom Nose Sill #737 (2345)
1-1/2 × 1-5/8
PVC | PVCSN16

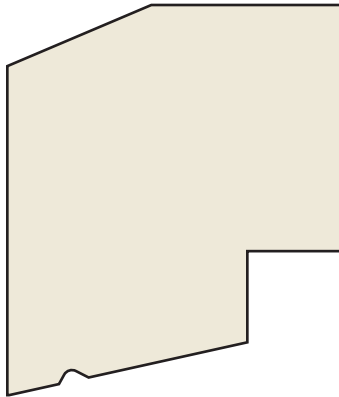

Historical Sill
1-3/4 × 2-1/32
PVC | MLD85310BP-16

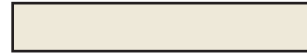

Lattice
1/4 × 1-35/64
PVC | WM266PVC

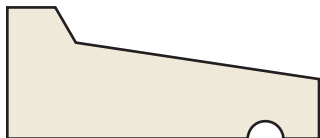

WM-197 Drip Cap
11/16 × 1-5/8
PVC | PVCDC197

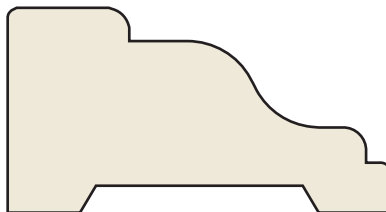

WM-287 Shingle Mould
1-1/16 × 2
PVC | WM287PVC16

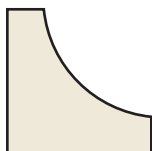

Scotia
3/4 × 3/4
PVC | VER9316

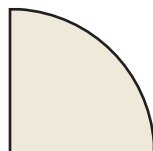

105 Quarter Round
3/4 × 3/4
PVC | WM106PVC16

SCALE: Actual Size

Exterior

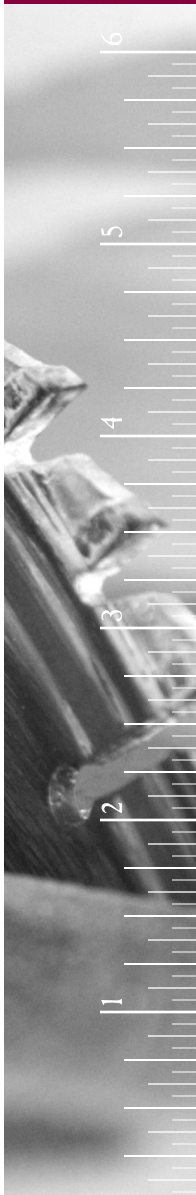

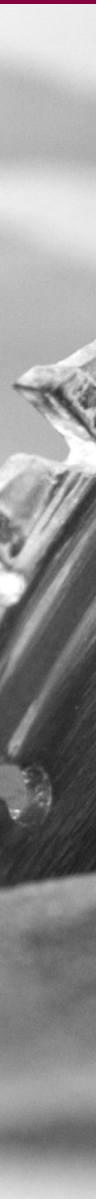

📍 SCALE: Actual Size



ALEXANDRIA, VA

6295-20 Edsall Road | Alexandria, Virginia 22312 | 703.823.2100

BLDR.com