

2019-2021 Product Guide

Anchoring, Fastening Systems and Restoration
Solutions for Concrete and Masonry

(800) 999-5099 | strongtie.com

SIMPSON

Strong-Tie

®



NOZZLE INCLUDED
DE MEZCLADO INCLUIDO
BÉLANGE INCLUS

SIMPSON

Strong-Tie

SET-3G™

**Cracked
Concrete**
CODE LISTED

**High-Strength
Anchoring Adhesive**

For Concrete with Threaded Rod

Usage
Use
Utilisation

Storage
Storage
Entreposage

Strength Beyond Steel



At Simpson Strong-Tie, we don't just deliver products. We deliver our commitment to your success.

From anchoring adhesives and mechanical anchors to direct fastening for concrete, steel, CMU and metal decking — we have the quality solutions you need to secure, repair and protect your structures.

Every innovative, high-performance product in this product guide is backed by our unparalleled engineering expertise, field support and customer service. So you can feel confident knowing you're building the safest, strongest structures possible.

Technical insight. Project design. Sales assistance. Problem solving is our passion — and our teams are here to support you whenever and wherever you need them.

Simpson Strong-Tie Company Inc.

**The Simpson Strong-Tie Company Inc.
"No Equal" pledge includes:**

- Quality products value-engineered for the lowest installed cost at the highest-rated performance levels
- The most thoroughly tested and evaluated products in the industry
- Strategically located manufacturing and warehouse facilities
- National code agency listings
- The largest number of patented connectors in the industry
- Global locations with an international sales team
- In-house R&D and tool-and-die professionals
- In-house product testing and quality control engineers
- Support of industry groups including AISI, AITC, ASTM, ASCE, AWC, AWPA, ACI, AISC, CSI, CFSEI, ICFA, NBMDA, NLBMDA, SBCA, SDI, SETMA, SFA, SFIA, STAFDA, SREA, NFBA, TPI, WDSC, WIJMA, WTCA and local engineering groups

The Simpson Strong-Tie Quality Policy

We help people build safer structures economically. We do this by designing, engineering and manufacturing "No Equal" structural connectors and other related products that meet or exceed our customers' needs and expectations. Everyone is responsible for product quality and is committed to ensuring the effectiveness of the Quality Management System.



Karen Colonias
Chief Executive Officer

We Are ISO 9001-2008 Registered



Simpson Strong-Tie is an ISO 9001-2008 registered company. ISO 9001-2008 is an internationally recognized quality assurance system that lets our domestic and international customers know they can count on the consistent quality of Simpson Strong-Tie® products and services.

(800) 999-5099 | strongtie.com

All Rights Reserved. This guide may not be reproduced in whole or in part without the prior written approval of Simpson Strong-Tie Company Inc.

Product Identification Key

Products and additional information are divided into general categories, identified by tabs along the page's outer edge.

Adhesive Anchors

16-49 ▶

Mechanical Anchors

50-109 ▶

Direct Fastening Solutions

110-139 ▶

Restoration Solutions

140-175 ▶

Carbide Drill Bits

176-195 ▶

Appendix

196-223 ▶

Alphabetical Index of Products



224-226 ▶

Table of Contents

Adhesive Anchors

Adhesive Accessories	28
Adhesive Anchoring Installation Instructions	42
Adhesive Retaining Caps	33
AT-XP® Acrylic Adhesive	26
ET-HP® Epoxy Adhesive	22
Hole-Cleaning Brushes	31
Opti-Mesh Adhesive Anchoring Screen Tubes	34
Piston Plug Adhesive Delivery System	32
Retrofit Bolt (RFB and ATR)	38
SET Epoxy Adhesive	24
 SET-3G™ Epoxy Adhesive	18
SET-XP® Epoxy Adhesive	20
Steel Adhesive-Anchoring Screen Tubes	36
Speed Clean™ Dust Extraction System	40

Mechanical Anchors

Crimp Drive® Anchor	104
CSD/DSD Split-Drive Anchors	107
Drop-In Internally Threaded Anchor (DIAB)	90
Drop-In Internally Threaded Anchor (DIA)	96
Easy-Set Pin-Drive Expansion Anchor	73
Hollow Drop-In Anchor	98
Sleeve-All® Sleeve Anchor	70
Split-Drive Anchor	107
Steel Rod Hanger	85
 Strong-Bolt® 2 Stainless-Steel Wedge Anchor	62
Strong-Bolt® 2 Wedge Anchor	62
Sure Wall Drywall Anchor	109
Tie-Wire Wedge Anchor	75
 Titen HD® Countersunk Screw Anchor	58
Titen HD® Heavy-Duty Screw Anchor	52
 Titen HD® Stainless-Steel Heavy-Duty Screw Anchor	56
Titen® 2 Concrete and Masonry Screw	76
Titen® Stainless-Steel Concrete and Masonry Screw	79
Titen HD® Rod Hanger	83
Titen HD® Rod Coupler	60
Wedge-All® Wedge Anchor	66
Wood Rod Hanger	88
Zinc Nailon™ Pin Drive Anchors	102

New products are shown with the  symbol.

Table of Contents

Direct Fastening Solutions

Extension Pole Tools	122
Gas-Actuated Fasteners and Accessories	118
GCN-MEPMAGKT Concrete Nailer	116
Powder-Actuated Fasteners.....	133
Powder-Actuated Tool/Load/Fastener Matrix	112
Powder-Actuated Tool Matrix	123
Powder Loads.....	131
PTP-27L.....	124
PT-27	126
PT-22A.....	128
PT-22HA	130

Restoration Solutions

CIP-F Flexible Paste-Over Adhesive and Crack Sealant	148
CIP-LO Low Odor Paste-Over Epoxy and Crack Sealant.....	148
Crack Injection Guide	151
Crack-Pac® Flex-H ₂ O™	146
Crack-Pac® Injection Epoxy	144
Crack Repair Accessories	150
CSS Composite Strengthening Systems™	170
Epoxy Injection Guide.....	156
ETI Injection Epoxy	142
FX-70® Structural Pile Repair and Protection System.....	166
Heli-Tie™ Helical Stitching Tie	164
Heli-Tie™ Helical Wall Tie	160

Carbide Drill Bits and Accessories

Core Bits	194
Demolition Bits	191
Rebar Cutters	189
Rebar Adapters.....	190
SDS-max® Drill Bits	185
SDS-plus® Drill Bits	181
Spline/Straight Shank Drill Bits	186

Appendix

Acceptable Hole Diameter	221
Anchor Products for Corrosive Environments.....	198
Anchoring and Fastening Applications by Market.....	204
Length Identification Head Marks.....	220

Important Information and General Notes

Limited Warranty

Simpson Strong-Tie Company Inc. warrants catalog products to be free from defects in material or manufacturing. Simpson Strong-Tie Company Inc. products are further warranted for adequacy of design when used in accordance with design limits in this catalog and when properly specified, installed and maintained. This warranty does not apply to uses not in compliance with specific applications and installations set forth in this catalog, or to non-catalog or modified products, or to deterioration due to environmental conditions.

Simpson Strong-Tie® anchors, fasteners and connectors are designed to enable structures to resist the movement, stress and loading that results from impact events such as earthquakes and high-velocity winds. Other Simpson Strong-Tie products are designed to the load capacities and uses listed in this catalog. Properly installed Simpson Strong-Tie products will perform in accordance with the specifications set forth in the applicable Simpson Strong-Tie catalog. Additional performance limitations for specific products may be listed on the applicable catalog pages.

Due to the particular characteristics of potential impact events, the specific design and location of the structure, the building materials used, the quality of construction, and the condition of the soils involved, damage may nonetheless result to a structure and its contents even if the loads resulting from the impact event do not exceed Simpson Strong-Tie catalog specifications and Simpson Strong-Tie connectors are properly installed in accordance with applicable building codes.

All warranty obligations of Simpson Strong-Tie Company Inc. shall be limited, at the discretion of Simpson Strong-Tie Company Inc., to repair or replacement of the defective part. These remedies shall constitute the sole obligation of Simpson Strong-Tie Company Inc. and the sole remedy of purchaser under this warranty. In no event will Simpson Strong-Tie Company Inc. be responsible for incidental, consequential, or special loss or damage, however caused.

This warranty is expressly in lieu of all other warranties, expressed or implied, including warranties of merchantability or fitness for a particular purpose, all such other warranties being hereby expressly excluded. This warranty may change periodically — consult our website strongtie.com for current information.

Important Information and General Notes

Terms and Conditions of Sale

Product Use

Products in this catalog are designed and manufactured for the specific purposes shown, and should not be used with other connectors not approved by a qualified Designer. Modifications to products or changes in installations should only be made by a qualified Designer. The performance of such modified products or altered installations is the sole responsibility of the Designer.

Indemnity

Customers or Designers modifying products or installations, or designing non-catalog products for fabrication by Simpson Strong-Tie Company Inc. shall, regardless of specific instructions to the user, indemnify, defend and hold harmless Simpson Strong-Tie Company Inc. for any and all claimed loss or damage occasioned in whole or in part by non-catalog or modified products.







Non-Catalog and Modified Products

Consult Simpson Strong-Tie Company Inc. for applications for which there is no catalog product, or for connectors for use in hostile environments, with excessive wood shrinkage, or with abnormal loading or erection requirements.

Non-catalog products must be designed by the customer and will be fabricated by Simpson Strong-Tie in accordance with customer specifications.

Simpson Strong-Tie cannot and does not make any representations regarding the suitability of use or load-carrying capacities of non-catalog products. Simpson Strong-Tie provides no warranty, express or implied, on non-catalog products. F.O.B. Shipping Point unless otherwise specified.

Product Selection Guide







Product	Page No.	Tested Base Materials and Code Listings								Other Listings
		Concrete		Concrete on Metal Deck	CMU		Unreinforced Clay Brick Masonry	Other		
		Cracked	Uncracked		Grout-Filled	Hollow				
  SET-3G™	18	ESR-4057 (City of L.A. Report within ESR)	—	—	—	—	—	—	—	NSF/ANSI Std 61 ASTM C881/ AASHTO M-235, DOT
 SET-XP®	20	ESR-2508, RR25744, FL-17449.2	—	ER-265, RR25965, FL-16230.3	ER-265, RR25965, FL-16230.3	—	—	—	—	NSF/ANSI Std 61 ASTM C881/ AASHTO M-235, DOT
 ET-HP®	22	ESR-3372, FL-17449.1	—	—	ER-241 FL-16230.2	—	—	—	—	ASTM C881/ AASHTO M-235, DOT
 SET	24	—	Non-IBC	—	—	Non-IBC	—	—	—	NSF/ANSI Std 61 ASTM C881/ AASHTO M-235, DOT
 AT-XP®	26	ER-263, RR25960, FL-16230.1	—	—	ER-281, RR25966, FL-16230.1	—	—	—	—	NSF/ANSI Std 61 ASTM C881/ AASHTO M-235, DOT
Adhesive Anchors										

Product Selection Guide

ASTM C881/ AASHTO M-235	NSF/ANSI Std 61 ASTM C881/ AASHTO M-235	ASTM C881/ AASHTO M-235	ASTM C881/ AASHTO M-235	ASTM C881/ AASHTO M-235	—
—	—	—	—	—	Wood Metal Stud
—	—	—	—	—	Non-IBC
—	—	—	—	—	Non-IBC
—	—	—	—	—	Non-IBC
—	—	—	—	—	—
—	—	—	—	—	Non-IBC
—	—	—	—	—	—
142	142	142	144	146	160
					
ETI-SLV	ETI-LV	ETI-GV	Crack-Pac®	Crack-Pac® Flex H ₂ O	Heil-Tie™
Restoration Solutions					

Refer to footnotes on page 13.





Product Selection Guide

Product	Page No.	Tested Base Materials and Code Listings										Other Listings
		Concrete		Concrete on Metal Deck	CMU		Unreinforced Clay Brick Masonry	Other	Concrete		Other	
		Cracked	Uncracked		Grout-Filled	Hollow			Cracked	Uncracked		
 Titan HD® (THD)	52	ESR-2713, RR25741, FL-15730.6			ESR-1056, RR25560, FL-15730.6		IBC				FM, DOT	
		ER-493			ESR-1056, RR25560, FL-15730.6							IBC
 Titan HD® Stainless-Steel (THD-SS)	56	ER-493			ESR-1056, RR25560, FL-15730.6		IBC				FM, DOT	
		ESR-2713, RR25741, FL-15730.6			ESR-1056, RR25560, FL-15730.6							IBC
 Titan HD® Countersunk Screw Anchor	58	ESR-2713, RR25741, FL-15730.6			ESR-1056, RR25560, FL-15730.6		IBC				FM, DOT	
		Non-IBC			ESR-1056, RR25560, FL-15730.6							
 Titan HD® Rod Coupler (THD-RC)	60	Non-IBC									—	
		ESR-3037, RR25891, FL-15731.2			ESR-3037, RR25891, FL-15731.2							
 Strong-Bolt® 2 (STB2)	62	ESR-3037, RR25891, FL-15731.2			ESR-3037, RR25891, FL-15731.2						UL, FM, DOT	
		Non-IBC			Non-IBC							
 Wedge-All® (WA)	66	Non-IBC			ESR-1396, FL-15730.7						UL, FM, DOT	
					ESR-1396, FL-15730.7							
Mechanical Anchors												

Product Selection Guide

Product	Page No.	Tested Base Materials and Code Listings										Other Listings
		Concrete		Concrete on Metal Deck	CMU		Unreinforced Clay Brick Masonry	Other				
		Cracked	Uncracked		Grout-Filled	Hollow						
 Steel Rod Hanger (RSH, RSV)	85	—	—	—	—	—	IBC (Steel)	UL, FM				
 Wood Rod Hanger (RWH, R WV)	88	—	—	—	—	—	IBC (Wood)	UL, FM				
 Drop-In (DIAB)	90	—	Non-IBC	—	—	—	Non-IBC (Hollow Core Panel)	UL, FM				
 Stainless Steel Drop-In (DIA-SS) (DIAS - Shorts)	96	—	Non-IBC	—	—	—	—	UL, FM, DOT				
 Hollow Drop-In (HDIA)	98	—	Non-IBC	—	—	IBC	—	UL, FM				
 Zinc Nalton™ (ZN)	102	—	Non-IBC	—	—	—	—	—				
Mechanical Anchors												

Product Selection Guide

Mechanical Anchors	Crimp Drive® (CD)		104	—	Non-IBC	Non-IBC	—	—	—	—	—	FM
	Split Drive (CSD, DSD)		107	—	Non-IBC	—	—	—	—	—	—	—
	Sure Wall (SWN, SWZ)		109	—	—	—	—	—	—	—	Drywall	—
	Powder-Actuated Fasteners		133	—	ESR-2138, RR25469, FL-15730.3, FL-15730.4	ESR-2138, RR25469, FL-15730.3, FL-15730.4	ESR-2138, RR25469, FL-15730.3, FL-15730.4	ESR-2138, RR25469, FL-15730.3, FL-15730.4	—	—	Steel ESR-2138, RR25469, FL-15730.3, FL-15730.4	FM
			118	—	ESR-2811, RR25837, FL-15730.1, FL-15730.2	ESR-2811, RR25837, FL-15730.1, FL-15730.2	ESR-2811, RR25837, FL-15730.1, FL-15730.2	ESR-2811, RR25837, FL-15730.1, FL-15730.2	—	—	Steel ESR-2811, FL-15730.1, FL-15730.2	—
Direct Fastening	Gas-Actuated Fasteners		118	—	—	—	—	—	—	—	—	—

Non-IBC — Load data is available in this catalog, but it is outside the scope of the current IBC. May be permitted for non-IBC applications.

UL — Underwriters Laboratories listing available.

FM — Factory Mutual listing available.

DOT — Various departments of transportation listings available.

See strongtie.com/DOT for details.

ESR — ICC-ES code report available at icc-es.org.

ER — IAPMO UES code report available at iapmoes.org.

RR — City of Los Angeles research report available.

FL — Florida building code approval available.

IBC — Load data is available in this catalog intended for use under IBC, but code listings are not available.

Consult the code listings for more detailed information on which models of each product are covered by the listing.

Rebar Development Length Calculator

Rebar Development Length Calculator is a web application that supports the design of post-installed rebar in concrete applications by calculating the necessary tension and compression development lengths required in accordance with ACI 318-14 / ACI 318-11.

Splice Information

Lap Splice Application: No
Splice Class: Class 3

Concrete Information

Concrete Type: NWC
Concrete Compressive Strength, f'_c (psi): 2,500

Rebar Information

Rebar Coating: Uncoated / Zinc coated
Rebar Spacing (Center-to-Center), S (in): 8
Minimum Clear Cover, C_{min} (in): 3

Seismic Design Category

Seismic Design Category: A-B

Buttons: RESTART, CALCULATE

Diagrams: Lap Splice Application (Existing cast-in-place reinforcing bar, Existing concrete, New concrete, Post-installed reinforcing bar, Development length)

Visit: strongtie.com/softwareandwebapplications/category.



Anchor Designer Software for ACI318, ETAG and CSA

Simpson Strong-Tie Anchor Designer software accurately analyzes existing design or suggests anchor solutions based on user-defined design elements in cracked and uncracked concrete conditions.

Visit strongtie.com/softwareandwebapplications/category for links to our Solutions Apps and Calculators.

Adhesive Cartridge Estimator

If you need to know how much adhesive to use for your next project, the Adhesive Cartridge Estimator makes it easy to estimate just how much is required. All you have to do is input the size and number of adhesive anchors to get the number of adhesive cartridges necessary for the job. And you can print the results for future reference.

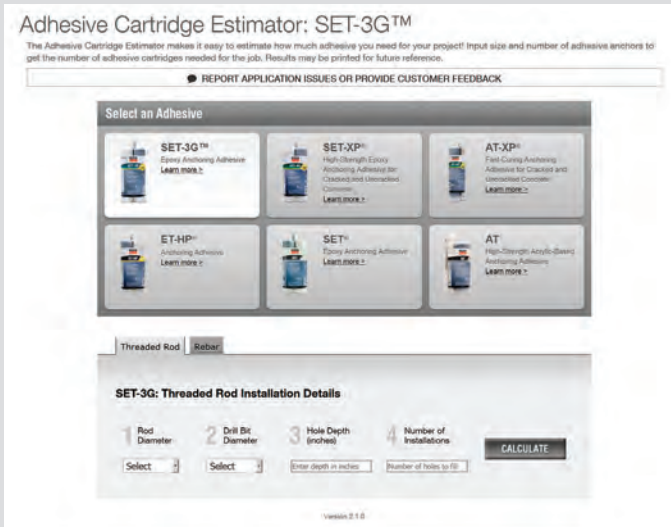

Visit: strongtie.com/softwareandwebapplications/category.

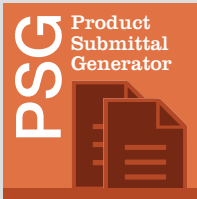

Product Submittal Generator

For our Product Submittal Generator, please visit: strongtie.com/resources/product-submittal-generator.



SIMPSON
Strong-Tie

Crack
Concrete
SET-3G

High-Strength
Anchoring Epoxy
Adhesive for
Rebar

Adhesive Anchors



SET-3G™ High-Strength Epoxy Adhesive

SET-3G is a 1:1 ratio, two-component, high-strength, epoxy-based anchoring adhesive for cracked and uncracked concrete. SET-3G installs and performs in a variety of environmental conditions and temperature extremes.

Features

- Jobsite versatility — can be installed in dry, water-saturated or water-filled holes in base materials with temperatures between 40°F (4°C) and 100°F (38°C)
- Two-year shelf life for unopened cartridges stored between 45°F (7°C) and 90°F (32°C)
- When properly mixed, SET-3G will be a uniform gray color
- Hole-cleaning wire brushes with blow-brush-blow method or Speed Clean™ DXS drill bits without any further cleaning

Applications

- Threaded rod anchor and rebar dowel installations in cracked and uncracked concrete
- Installation in downward, horizontal and upwardly inclined (including overhead) orientations

Codes

ICC-ES ESR-4057 (concrete); City of Los Angeles (see ICC-ES ESR-4057); AASHTO M235 and ASTM C881, Types I and IV, Grade 3, Class C; NSF/ANSI Standard 61 (300 in.²/1,000 gal.)

Chemical Resistance

Contact Simpson Strong-Tie for information.

Installation and Application Instructions

- Surfaces to receive epoxy must be clean per approved hole cleaning method.
- Base-material temperatures must be 40°F (4°C) or above at the time of installation. For best results, adhesive should be conditioned to a temperature between 70°F (21°C) and 80°F (37°C) at the time of installation.
- To warm cold adhesive, store cartridges in a warm, uniformly heated area or storage container. Do not immerse cartridges in water or use microwave to facilitate warming.
- Mixed material can harden in the dispensing nozzle within 30 minutes at 70°F (21°C).

Note: For full installation instructions, see product packaging or visit strongtie.com/set3g.



SET-3G Adhesive

SET-3G™ High-Strength Epoxy Adhesive

SET-3G Adhesive Cartridge System

Model No.	Capacity (ounces)	Cartridge Type	Carton Quantity	Dispensing Tool(s)	Mixing Nozzle
SET3G10 ¹	8.5	Coaxial	12	CDT10S	EMN22I
SET3G22-N ¹	22	Side-by-side	10	EDT22S, EDTA22P, EDTA22CKT	EMN22I

1. One EMN22I mixing nozzle and one extension are supplied with each cartridge.
2. Cartridge estimation guidelines are available at strongtie.com/apps.
3. Use only Simpson Strong-Tie® mixing nozzles in accordance with Simpson Strong-Tie instructions. Modification or improper use of mixing nozzle may impair SET-3G adhesive performance.

SET-3G Cure Schedule^{1,2}

Concrete Temperature		Gel Time	Cure Time
(°F)	(°C)	(min.)	(hr.)
40	4	120	192
50	10	75	72
60	16	50	48
70	21	35	24
90	32	25	24
100	38	15	24

For SI: 1°F = (°C x 9/5) + 32.

1. For water-saturated concrete and water-filled holes, the cure times should be doubled.
2. For installation of anchors in concrete where the temperature is below 70°F (21°C), the adhesive must be conditioned to a minimum temperature of 70°F (21°C).

SET-XP® High-Strength Epoxy Adhesive

SET-XP is a 1:1 ratio, two-component, high-strength, epoxy-based anchoring adhesive for anchoring and doweling in cracked and uncracked concrete and masonry applications.

Features

- Suitable for use in dry or water-saturated concrete
- For best results, store between 45°F (7°C) and 90°F (32°C)
- Hole-cleaning nylon brushes with blow-brush-blow method or Speed Clean™ DXS drill bits without any further cleaning

Applications

- Threaded rod anchoring and rebar doweling into concrete and masonry
- Recognized per AC308 to be used for rebar development and splice length design provisions of ACI 318
- Suitable for horizontal, vertical and overhead applications

Codes

ICC-ES ESR-2508 (concrete); IAPMO UES ER-265 (masonry); City of L.A. RR25744 (concrete), RR25965 (masonry); Florida FL-17449.2 (concrete), FL-16230.3 (masonry); AASHTO M-235 and ASTM C881 (Type I and IV, Grade 3, Class C); NSF/ANSI Standard 61 (216 in.²/1,000 gal.)

Installation and Application Instructions

- Surfaces to receive epoxy must be clean.
- Base material temperature must be 50°F (10°C) or above at the time of installation. For best results, material should be between 70°F (21°C) and 80°F (27°C) at time of application.
- To warm cold material, store cartridges in a warm, uniformly heated area or storage container. Do not immerse cartridges in water or use microwave to facilitate warming.
- Mixed material in nozzle can harden in 30 minutes at temperatures of 70°F (21°C) and above.

Suggested Specifications

See strongtie.com for more information.



SET-XP Adhesive

SET-XP® High-Strength Epoxy Adhesive

SET-XP Cartridge System

Model No.	Capacity (ounces)	Cartridge Type	Carton Quantity	Dispensing Tool(s)	Mixing Nozzle
SET-XP10 ⁴	8.5	Single	12	CDT10S	EMN22I
SET-XP22	22	Side-by-Side	10	EDT22S, EDTA22P, EDTA22CKT	
SET-XP22-N ⁴	22	Side-by-Side	10	EDT22S, EDTA22P, EDTA22CKT	
SET-XP56	56	Side-by-Side	6	EDTA56P	

1. Cartridge estimation guidelines are available at strongtie.com/apps.
2. Detailed information on dispensing tools, mixing nozzles and other adhesive accessories is available at strongtie.com.
3. Use only Simpson Strong-Tie mixing nozzles in accordance with Simpson Strong-Tie instructions. Modification or improper use of mixing nozzle may impair SET-XP adhesive performance.
4. One EMN22I mixing nozzle and one nozzle extension are supplied with each cartridge.

Cure Schedule

Base Material Temperature		Gel Time (minutes)	Cure Time (hrs.)
°F	°C		
50	10	75	72
60	16	60	48
70	21	45	24
90	32	35	24
110	43	20	24

For water-saturated concrete, the cure times must be doubled.

ET-HP® Epoxy Adhesive

ET-HP is a two-component, high-solids, epoxy-based system for use as a high-strength, non-shrink anchor-grouting material. Resin and hardener are dispensed and mixed simultaneously through the static mixing nozzle. ET-HP is formulated for anchoring threaded rod and rebar into concrete (cracked/uncracked) and masonry.

Features

- Suitable for use under static and seismic loading conditions in cracked and uncracked concrete and masonry
- Suitable for use in dry or water-saturated concrete
- When properly mixed, adhesive will be a uniform gray color
- Hole-cleaning nylon brushes with blow-brush-blow method

Applications

- Threaded rod anchoring and rebar doweling into concrete and unreinforced masonry
- Suitable for horizontal, vertical and overhead applications

Codes

ICC-ES ESR-3372 (concrete); ICC-ES ESR-3638 (unreinforced masonry); IAPMO UES ER-241 (masonry); City of L.A. RR25120 (unreinforced masonry); AASHTO M-235 and ASTM C881 (Type IV, Grade 3, Class C); multiple DOT listings; FL-17449.1; FL-16230.2

Installation and Application Instructions

- Surfaces to receive epoxy must be clean.
- Base material temperature must be 50°F (10°C) or above at the time of installation. For best results, material should be between 70°F (21°C) and 80°F (27°C) at time of application.
- To warm cold material, store cartridges in a warm, uniformly heated area or storage container. Do not immerse cartridges in water or use microwave to facilitate warming.
- Mixed material in nozzle can harden in 30 minutes at temperatures of 70°F (21°C) and above.

Suggested Specifications

See strongtie.com for more information.



ET-HP Adhesive

ET-HP® Epoxy Adhesive

ET-HP Package Systems

Model No.	Capacity (ounces)	Package Type	Carton Quantity	Dispensing Tools	Mixing Nozzle
ET-HP22-N [†]	22	Side-by-side	10	EDT22S	EMN22i
ET-HP22	22	Side-by-side	10	EDT22CKT	EMN22i

1. Cartridge estimation guidelines are available at strongtie.com/apps.
2. Detailed information on dispensing tools, mixing nozzles and other adhesive accessories is available at strongtie.com.
3. Use only Simpson Strong-Tie® mixing nozzles in accordance with Simpson Strong-Tie instructions. Modification or improper use of mixing nozzle may impair ET-HP adhesive performance.
4. One EMN22i mixing nozzle and one nozzle extension are supplied with each cartridge.

Cure Schedule

Base Material Temperature		Gel Time (minutes)	Cure Time ¹ (hrs.)
°F	°C		
50	10	45	72
60	16	30	24
80	27	20	24
100	38	15	24

1. For water-saturated concrete, the cure times must be doubled.

SET Epoxy Adhesive

SET is a high-strength, non-shrink, epoxy-based adhesive formulated for anchoring and doweling threaded rod and rebar. Resin and hardener are dispensed and mixed simultaneously through the mixing nozzle.

Features

- Suitable for use in damp or wet anchor sites
- When properly mixed, adhesive will be a uniform gray color
- Hole-cleaning nylon brushes with blow-brush-blow method

Applications

- Threaded rod anchoring and rebar doweling into concrete, masonry and URM (red brick)
- Pick-proof sealant around doors, windows and fixtures
- Paste-over for crack injection preparation
- Bonding hardened concrete to hardened concrete
- Caltrans listing

Codes

ICC-ES ESR-1772 (unreinforced masonry); Florida FL15730.5; AASHTO M-235 and ASTM C881 (Type I and IV, Grade 3, Class C); CalTrans Approved; Multiple DOT listings; NSF/ANSI Standard 61 (216 in.²/1,000 gal.)

Installation and Application Instructions

- Surfaces to receive epoxy must be clean.
- Base material temperature must be 40°F (4°C) or above at the time of installation. For best results, material should be between 70° (21°C) and 80°F (27°C) at time of application.
- To warm cold material, store cartridges in a warm, uniformly heated area or storage container. Do not immerse cartridges in water or use microwave to facilitate warming.
- Mixed material in nozzle can harden in 30 minutes at temperatures of 70°F (21°C) and above.

Suggested Specifications

See strongtie.com for more information.



SET Adhesive

SET Epoxy Adhesive

SET Cartridge System

Model No.	Capacity (ounces)	Cartridge Type	Carton Quantity	Dispensing Tools	Mixing Nozzle
SET22	22	Side-by-side	10	EDT22S, EDTA22CKT EDTA22P	EMN22I
SET22-N ⁴	22	Side-by-side	10		EMN22I

1. Cartridge estimation guidelines are available at strongtie.com/apps.
2. Detailed information on dispensing tools, mixing nozzles and other adhesive accessories is available at strongtie.com.
3. Use only Simpson Strong-Tie mixing nozzles in accordance with Simpson Strong-Tie instructions. Modification or improper use of mixing nozzle may impair SET adhesive performance.
4. One EMN22I mixing nozzle and one nozzle extension are supplied with each cartridge.

Cure Schedule

Base Material Temperature		Cure Time (hrs.)
°F	°C	
40	4	72
65	18	24
85	29	20
90	32	16

For water-saturated concrete (including damp and water-filled holes), the cure times must be doubled.

In-Service Temperature Sensitivity

Base Material Temperature		Percent Allowable Load
°F	°C	
40	4	100%
70	21	100%
110	43	100%
135	57	75%
150	66	44%
180	82	20%

1. Percent allowable load may be linearly interpolated for intermediate base material temperatures.
2. $^{\circ}\text{C} = (^{\circ}\text{F} - 32) / 1.8$

AT-XP® High-Strength Acrylic Adhesive

AT-XP is a 10:1 ratio, two-component, high-strength acrylic-based anchoring adhesive for use in threaded rod and rebar into cracked and uncracked concrete and masonry under a wide range of conditions. AT-XP adhesive dispenses easily in cold or warm environments and in below-freezing temperatures with no need to warm the cartridge.

Features

- Suitable for use in dry or water-saturated concrete.
- Tested per ACI 355.4 and AC308.
- For best results, store between 14°F (-10°C) and 80°F (27°C).
- Cures in substrate temperatures as low as 14°F in 24 hours or less. Cures in 15 minutes at 86°F.
- Hole-cleaning nylon brushes with blow-brush-blow method or Speed Clean™ DXS drill bits without any further cleaning.

Applications

- Threaded rod anchoring and rebar doweling into concrete and masonry
- Suitable for horizontal, vertical and overhead applications

Codes

IAPMO UES ER-263 (concrete); IAPMO UES ER-281 (masonry); City of L.A. RR25960 (concrete), RR25966 (masonry); FL-16230.1; NSF/ANSI Standard 61 (43.2 in.²/1,000 gal.); AASHTO M-235 and ASTM C881 (Type I and IV, Grade 3, Class C — except AT-XP is a non-epoxy formulated for fast cure time)

Installation and Application Instructions

- Surfaces to receive adhesive must be clean.
- Base material temperature must be 14°F or above at the time of installation. For best results, material should be between 14°F (-10°C) and 80°F (27°C) at time of application.
- To warm cold material, store cartridges in a warm, uniformly heated area or storage container. Do not immerse cartridges in water or use microwave to facilitate warming.
- Mixed material in nozzle can harden in 3–4 minutes at temperatures of 70°F (21°C) and above.

Suggested Specifications

See strongtie.com for more information.



AT-XP Adhesive

AT-XP® High-Strength Acrylic Adhesive

AT-XP Adhesive Cartridge System

Model No.	Capacity ounces (cubic in.)	Cartridge Type	Carton Qty.	Dispensing Tool	Mixing Nozzle
AT-XP10 ⁴	9.4 (16.9)	Coaxial	6	CDT10S	AMN19Q
AT-XP13 ⁴	12.5 (22.5)	Side-by-side	10	ADT813S	
AT-XP30 ⁴	30 (54)	Side-by-side	5	ADT30S ADTA30P or ADTA30CKT	

1. Cartridge estimation guidelines are available at strongtie.com/apps.
2. Detailed information on dispensing tools, mixing nozzles and other adhesive accessories is available at strongtie.com.
3. Use only Simpson Strong-Tie® mixing nozzles in accordance with Simpson Strong-Tie instructions. Modification or improper use of mixing nozzle may impair AT-XP adhesive performance.
4. One AMN19Q mixing nozzle and one nozzle extension are supplied with each cartridge.

Cure Schedule

Base Material Temperature		Gel Time (minutes)	Cure Time (hrs.)
°F	°C		
14	-10	30	24
32	0	15	8
50	10	7	3
68	20	4	1
86	30	1½	30 min.
100	38	1	20 min.

For water-saturated concrete, the cure times must be doubled.

Adhesive Accessories

Adhesive Dispensing Tools

Our heavy-duty tools are designed to work with our cartridges for trouble-free dispensing. Each manual tool provides a 26:1 drive mechanism for easier dispensing of high-viscosity adhesive.

CDT10S**Manual Dispensing Tool for Single Cartridge Adhesives**

The CDT10S features a steel carriage for ultimate durability and is engineered for continuous, high-volume use, as well as double-gripping plates that help extend tool life.



CDT10S

EDT22S**Manual Dispensing Tool for 22 oz. Adhesive Cartridges**

The EDT22S epoxy adhesive tool features a steel carriage and is engineered for high-volume, continuous use. The tool can be easily converted (conversion parts included) from dispensing a 22 oz., 1:1 ratio cartridge to a 16.5 oz., 2:1 ratio cartridge.



EDT22S

EDTA22CKT**Battery-Powered Dispensing Tool for 22 oz. Cartridges**

The EDTA22C offers power dispensing of 22 oz., 1:1 ratio, dual-cartridge adhesives without the need for a hose or compressor. The 18V lithium-ion battery is 50% lighter than NiCad and offers 40% longer run time and 30-minute recharging. Tool converts to dispense 16.5 oz., 2:1 ratio dual-cartridge adhesives (conversion parts included). The EDTA22CKT comes with the dispensing tool, two 18V lithium-ion battery packs and a charger.

EDTA22CKT
Tool and Charger**EDTA22P****Pneumatic Dispensing Tool for 22 oz. Cartridges**

The EDTA22P tool features an optional suitcase handle adapter for the ultimate in tool configuration and dispensing convenience, enabling easier and time-saving ground-level doweling. The heavy-duty tool comes with a custom, blow-molded plastic carrying case.



EDTA22P

EDTA56P**Pneumatic Dispensing Tool for 56 oz. Cartridges**

The EDTA56P tool features an optional suitcase handle adapter for the ultimate in tool configuration and dispensing convenience, enabling easier and time-saving ground-level doweling. The heavy-duty tool comes with a custom, blow-molded plastic carrying case.



EDTA56P

Description	Model No.
Premium tool for single-tube cartridges	CDT10S
Manual tool for 22 oz. cartridges	EDT22S
Replacement 14.4V battery (ea.)	EDT14B
Battery-powered tool for 22 oz. cartridges	EDTA22CKT
Pneumatic tool for 22 oz. cartridges ^{1,2}	EDTA22P
Pneumatic tool for 56 oz. cartridges ^{1,2}	EDTA56P

1. Air supply attachment is ¼–18 NPT (male) thread.
2. Recommended operating air pressure is between 80 and 100 psi.

Maintenance tips, troubleshooting and repair parts schematics available at strongtie.com.

Adhesive Accessories

ADT813S Manual Dispensing Tool for 12.5 oz. Cartridges

The ADT813S features a steel carriage for ultimate durability. The ADT813S also features double-gripping plates that help extend tool life.



ADT813S

ADT30S Manual Dispensing Tool for 30 oz. Adhesive Cartridges

The ADT30S features a steel carriage for ultimate durability and is engineered for continuous, high-volume use, as well as double-gripping plates that help extend tool life. The tool can be easily converted from 30 oz. 10:1 cartridges to 32 oz. 2:1 cartridges.



ADT30S

ADTA30CKT Battery-Powered Dispensing Tool for 30 oz. Cartridges

The ADTA30C offers power dispensing of 30 oz., 10:1 ratio, dual-cartridge adhesives without the need for a hose or compressor. The tool features dosage and rate control for maximum efficiency on the job. The 18V lithium-ion battery is 50% lighter than NiCad and offers 40% longer run time. Recharging takes only 30 minutes. The ADTA30CKT comes with the dispensing tool, two 18V Lithium-ion battery packs and a charger.



ADTA30CKT

ADTA30P Pneumatic Dispensing Tool for 30 oz. Cartridges

The ADTA30P tool features an optional suitcase handle adapter for flexible tool configuration and dispensing convenience. The suitcase option enables easier and time-saving ground-level doweling. The heavy-duty tool comes with a custom, blow-molded plastic carrying case. The tool can be easily converted from 30 oz. 10:1 cartridges to 32 oz. 2:1 cartridges.



ADTA30P

Description	Model No.
Manual tool for 12.5 oz. cartridges	ADT813S
Manual tool for 30 oz. cartridges	ADT30S
Battery-powered tool for 30 oz. cartridges	ADTA30CKT
Pneumatic tool for 30 oz. cartridges ^{1,2}	ADTA30P

1. Air supply attachment is ¼-18 NPT (male) thread.
2. Recommended operating air pressure is between 80 and 120 psi .

Maintenance tips, troubleshooting and repair parts schematics available at strongtie.com.

Adhesive Nozzle Accessories

EMN22i

An 18-element mixing nozzle with integrated nut for use with 22 oz. and 56 oz. epoxy adhesive cartridges.

**EMN22i**

Model No.	Option	Package Quantity	Carton Quantity
EMN22i	18-element nozzle for 22 oz. and 56 oz. epoxy adhesive. Includes integrated threaded nut for attachment to cartridges.	1	12
EMN22i-RP10	18-element nozzle for 22 oz. and 56 oz. epoxy adhesive. Includes integrated threaded nut for attachment to cartridges.	10	3
EMN22i-RP5	18-element nozzle for 22 oz. and 56 oz. epoxy adhesive. Includes integrated threaded nut for attachment to cartridges.	5	6
EMN22iB	18-element nozzle for 22 oz. and 56 oz. epoxy adhesive. Includes integrated threaded nut for attachment to cartridges.	500	500

EMN50

A high-volume nozzle for 22 oz. and 56 oz. epoxy cartridges.

**EMN50**

Model No.	Option	Package Quantity
EMN50	Hi-volume nozzle for 22 oz. and 56 oz. cartridges (separate retaining nut not required), 17" long, major diameter 7/8"	10

AMN19Q

A 19-element high-strength static mixing nozzle for use with all acrylic adhesive products.

**AMN19Q**

Model No.	Option	Package Quantity	Carton Quantity
AMN19Q-RP5	Five mixing nozzles for AT-XP® product.	5 nozzles per pack	10

Adhesive Accessories

Hole-Cleaning Brushes

Brushes are used for cleaning drilled holes prior to adhesive installation.

Note: The standard hole-cleaning method (blow-brush-blow) can be avoided by using the Speed Clean™ vacuum dust extraction system (DXS) with SET-XP®, AT-XP® and SET-3G™. See p. 43 for details.

Nylon Brush – Standard

(For use with SET-XP, AT-XP, ET-HP® and SET)



Model No.	Hole Diameter (in.)	Anchor Diameter (in.)	Rebar Size	Usable Length (in.)	Carton Qty.
ETB4	3/8 – 7/16	1/4 – 5/16	—	7	24
ETB6	1/2 – 3/4	3/8 – 5/8	#3 – #5	15	24
ETB8	13/16 – 7/8	3/4	#6	15	24
ETB8L	13/16 – 7/8	3/4	#6	23	24
ETB10	1 – 1 1/8	7/8 – 1	#7 – #8	28	24
ETB12	1 3/16 – 1 3/8	1 1/4	#10	33	24

1. All standard nylon brushes are one-piece which includes a twisted wire handle.

Nylon Brush – Rebar

(For use with SET-XP)



Model No.	Hole Diameter (in.)	Rebar Size	Usable Length (in.)	Carton Qty.
ETB6R	1/2 – 3/4	#3 – #5	6	25
ETB8R	7/8	#6	6	25
ETB10R	1 – 1 1/8	#7 – #8	8	25
ETB12R	1 3/8	#10	8	25
ETB14R	1 3/4	#11	7	25
ETBR-EXT	T-handle and extension		35 1/4	25

1. ETBR-EXT is required for use with all sizes of rebar nylon brushes.
2. To obtain total usable length, add the usable length for each part used.

Wire Brush – Standard

(For use with SET-3G)



Model No.	Hole Diameter (in.)	Anchor Diameter (in.)	Rebar Size	Usable Length (in.)	Carton Qty.
ETB43S	7/16	3/8	—	5	25
ETB50S	1/2	—	#3	5	25
ETB56S	9/16	1/2	—	5	25
ETB62S	5/8	—	#4	5	25
ETB68S	11/16	5/8	—	5	25
ETB75S	3/4	—	#5	5	25
ETB87S	7/8	3/4	#6	5	25
ETB100S	1	7/8	#7	5	25
ETB112S	1 1/8	1	#8	5	25
ETB137S	1 3/8	1 1/4	#10	5	25
ETBS-TH	T-handle			8 1/2	25
ETBS-EXT	Extension			11 1/2	25

1. T-handle is required for use with all sizes of standard wire brush.
2. To obtain total usable length, add the usable length for each part used.

Adhesive Accessories

Piston Plug Delivery System

The piston plug delivery system for adhesives is an easy-to-use, reliable and less time-consuming means to dispense adhesive into drilled holes for threaded rod and rebar dowel installations in overhead, upwardly inclined and horizontal orientations. The matched tolerance design between the piston plug and drilled hole virtually eliminates the formation of voids and air pockets during adhesive dispensing.

The piston plug delivery system consists of three components: piston plug, flexible extension tubing, and adhesive retaining cap.



Features

- Designed for dispensing adhesive into drilled holes in overhead, upwardly inclined and horizontal orientations, as well as deep embedments
- Suitable for use with all Simpson Strong-Tie® anchoring adhesives
- Adhesive piston plugs are sized to fit each drilled hole diameter
- A barbed end provides a reliable connection to the flexible extension tubing
- Flexible extension tubing is available in 25'-long rolls to be cut to required lengths



Use the piston plug delivery system with all Simpson Strong-Tie adhesive products:



SET-3G™



SET-XP®



SET



AT-XP®



ET-HP®

Adhesive Accessories

Piston Plugs

Model No.	Hole Size (in.)	Package Quantity	Carton Quantity*
PP56-RP10	9/16	10	100
PP62-RP10	5/8	10	100
PP68-RP10	11/16	10	100
PP75-RP10	3/4	10	100
PP81-RP10	13/16	10	100
PP87-RP10	7/8	10	100
PP100-RP10	1	10	100
PP112-RP10	1 1/8	10	100
PP137-RP10	1 3/8	10	100
PP175-RP10	1 3/4	10	100

*10 packages of 10.



Tubing

Model No.	Description	Package Qty.
PPFT25	Piston plug flexible extension tubing — 25 ft. roll	1



Adhesive Retaining Caps

Adhesive retaining caps make overhead and horizontal installation easier by preventing the adhesive from running out of the hole. They also center the rod in the hole, making them ideal for applications where precise anchor placement is required. It may be necessary to provide support for the anchor during cure time. Adhesive retaining caps are not designed to support the weight of the anchor in overhead installations. Adhesive retaining caps should be used for horizontal and overhead adhesive installations.

ARCs may be used in conjunction with the piston plug delivery system.



Material: Plastic

Retaining Caps

Model No.	Hole Size (in.)	Anchor Dia. (in.)	Rebar Size	Cap Depth (in.)	Package Qty.	Carton Qty.* (ea.)
ARC37A-RP25	7/16	3/8	#3	7/16	25	200
ARC37-RP25	1/2	3/8		7/16	25	200
ARC50A-RP25	9/16	1/2	#4	1/2	25	200
ARC50-RP25	5/8	1/2		1/2	25	200
ARC62A-RP25	11/16	5/8	#5	9/16	25	200
ARC62-RP25	3/4	5/8		9/16	25	200
ARC75A-RP25	13/16	3/4	#6	9/16	25	200
ARC75-RP25	7/8	3/4		9/16	25	200
ARC87-RP25	1	7/8	#7	11/16	25	200
ARC100A-RP25	1 1/16	1	#8	11/16	25	200
ARC100-RP25	1 1/8	1		11/16	25	200
ARC125-RP25	1 3/8	1 1/4	#10	7/8	25	200
ARC137-RP25	1 3/4	—	#11	11/16	25	200

*Cartons contain 8 packages of 25.

Adhesive Accessories

Opti-Mesh Adhesive-Anchoring Screen Tubes

Screen tubes are vital to the performance of adhesive anchors in base materials that are hollow or contain voids, such as hollow block and brick. The Opti-Mesh screen tube with woven mesh insert provides the advantages of a plastic screen tube while providing superior performance to steel screen tubes and competitive plastic screen tubes.

Material: Plastic



Caution: Screen tubes are designed for a specific adhesive type. Epoxy screen tubes must be used with SET-XP® formulations. Acrylic screen tubes must be used with AT-XP®.



Epoxy Adhesive Screen Tube
(mesh is black)

U.S. Patent 6,837,018



The integral cap centers the rod and displays drill bit and rod diameter.



Adhesive Accessories

Screen Tubes — Plastic

For Rod Diameter (in.)	Hole Size (in.)	Length (in.)	Epoxy Model No. SET-XP®	Acrylic Model No. AT-XP®	Carton Quantity
3/8	9/16	3 1/2	EWS373P	AWS373P	150
		6	EWS376P	AWS376P	150
		10	EWS3710P	AWS3710P	100
1/2	3/4	3 1/2	EWS503P	AWS503P	100
		6	EWS506P	AWS506P	100
		10	EWS5010P	AWS5010P	50
5/8	7/8	3 1/2	EWS623P	AWS623P	50
		6	EWS626P	AWS626P	50
		10	EWS6210P	AWS6210P	25
3/4	1	8	EWS758P	AWS758P	25
		13	EWS7513P	AWS7513P	25



Specially sized holes in Opti-Mesh screens allow for adhesive to seep out at the appropriate location at the hollow portion of the CMU to create a better bond to the face shell.

Adhesive Accessories

Steel Adhesive-Anchoring Screen Tubes

Screen tubes are used in hollow base material applications to contain adhesive around the anchor and prevent it from running into voids. Simpson Strong-Tie® screen tubes are specifically designed to work with AT-XP®, SET and ET-HP® adhesives in order to precisely control the amount of adhesive that passes through the mesh. This results in thorough coating and bonding of the rod to the screen tube and base material. Order screen tubes based upon rod diameter and adhesive type. The actual outside diameter of the screen tube is larger than the rod diameter.

Material: Acrylic screen tubes: 50 mesh stainless steel
Epoxy screen tubes: 60 mesh carbon steel



Caution: Screen tubes are designed for a specific adhesive type. Epoxy screen tubes must be used with SET or ET-HP® formulations and acrylic screen tubes must be used with AT-XP®.



Epoxy Screen Tube

(acrylic screen tubes similar)

Screen tubes are for use in hollow CMU, hollow brick and unreinforced masonry applications. Contact Simpson Strong-Tie for information on special-order sizes.

Adhesive Accessories

Screen Tubes

For Rod Diameter (in.)	Hole Size (in.)	Acrylic Stainless Steel Screen Tubes for AT-XP		Epoxy Carbon Steel Screen Tubes for SET and ET-HP		Carton Qty.
		Actual Screen Size O.D./Length (in.)	Model No.	Actual Screen Size O.D./Length (in.)	Model No.	
3/8	9/16	1 ⁵ / ₃₂ X 3 1/2	ATS373	—	—	175
		1 ⁵ / ₃₂ X 6	ATS376	1 ⁵ / ₃₂ X 6	ETS376	150
		—	—	1 ⁵ / ₃₂ X 10	ETS3710	100
1/2	1 ¹ / ₁₆	1 ⁹ / ₃₂ X 3 1/2	ATS503	—	—	100
		1 ⁹ / ₃₂ X 6	ATS506	1 ⁹ / ₃₂ X 6	ETS506	100
		1 ⁹ / ₃₂ X 10	ATS5010	1 ⁹ / ₃₂ X 10	ETS5010	50
5/8	7/8	2 ⁵ / ₃₂ X 3	ATS623	—	—	50
		2 ⁵ / ₃₂ X 6	ATS626	2 ⁵ / ₃₂ X 6	ETS626	50
		2 ⁵ / ₃₂ X 10	ATS6210	2 ⁵ / ₃₂ X 10	ETS6210	25
		2 ⁵ / ₃₂ X 13	ATS6213	2 ⁵ / ₃₂ X 13	ETS6213	25
3/4	1	3 ¹ / ₃₂ X 8	ATS758	3 ¹ / ₃₂ X 8	ETS758	25
		3 ¹ / ₃₂ X 13	ATS7513	3 ¹ / ₃₂ X 13	ETS7513	25
		3 ¹ / ₃₂ X 17	ATS7517	3 ¹ / ₃₂ X 17	ETS7517	25
		—	—	3 ¹ / ₃₂ X 21	ETS7521	25

Adhesive Accessories

Retrofit Bolts

RFBs are pre-cut threaded rod, supplied with nut and washer (except stainless steel). For use with Simpson Strong-Tie® adhesives to anchor into existing concrete and masonry. Each end of the threaded rod is stamped with rod length in inches and our "No-Equal" symbol for easy identification after installation.

Material: ASTM F1554 Grade 36; 316 stainless steel

Coating: Zinc-plated; hot-dip galvanized



RFB
Retrofit Bolts

Description Dia. x Length (in.)	Model No.	Carton Quantity	Retail Pack Model No.	Retail Pack
Zinc-Plated				
1/2 x 4	RFB#4x4	50	—	—
1/2 x 5	RFB#4x5	50	—	—
1/2 x 6	RFB#4x6	50	—	—
1/2 x 7	RFB#4x7	50	RFB#4x7-R	10
1/2 x 10	RFB#4x10	25	RFB#4x10-R	10
5/8 x 5	RFB#5x5	50	—	—
5/8 x 8	RFB#5x8	50	—	—
5/8 x 10	RFB#5x10	25	—	—
5/8 x 16	RFB#5x16	25	—	—
3/4 x 10 1/2	RFB#6x10.5	25	—	—
Hot-Dip Galvanized				
1/2 x 4	RFB#4x4HDG	50	—	—
1/2 x 5	RFB#4x5HDG	50	RFB#4x5HDG-R	10
1/2 x 6	RFB#4x6HDG	50	RFB#4x6HDG-R	10
1/2 x 7	RFB#4x7HDG	50	RFB#4x7HDG-R	10
1/2 x 8	—	—	RFB#4x8HDG-R	10
1/2 x 10	RFB#4x10HDG	25	—	—
5/8 x 5	RFB#5x5HDG	50	RFB#5x5HDG-R	10
5/8 x 8	RFB#5x8HDG	50	RFB#5x8HDG-R	10
5/8 x 10	RFB#5x10HDG	50	—	—
5/8 x 12	—	—	RFB#5x12HDG-R	10
5/8 x 16	RFB#5x16HDG	25	RFB#5x16HDG-R	10
3/4 x 10 1/2	RFB#6x10.5HDG	25	—	—

1. Stainless-steel washers not included.

Adhesive Accessories

All Thread Rod

ATRs are pre-cut threaded rod for use with Simpson Strong-Tie® adhesives.

Material: ASTM F1554 Grade 36

Coating: Uncoated, zinc-plated; hot-dip galvanized

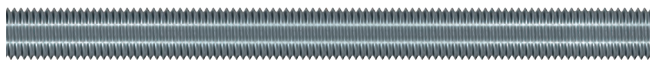

ATR
All Thread Rod

Description Dia. x Length (in.)	Uncoated Model No.	Zinc-Plated Model No.	Hot-Dip Galvanized Model No.	Carton Quantity
3/8 x 12	ATR3/8x12	—	—	1
3/8 x 24	ATR3/8x24	—	—	1
3/8 x 36	ATR3/8x36	—	ATR3/8x36HDG	1
1/2 x 12	ATR1/2x12	ATR1/2x12ZP	ATR1/2x12HDG	1
1/2 x 18	ATR1/2x18	—	ATR1/2x18HDG	1
1/2 x 24	ATR1/2x24	ATR1/2x24ZP	ATR1/2x24HDG	1
1/2 x 36	ATR1/2x36	ATR1/2x36ZP	ATR1/2x36HDG	1
5/8 x 12	ATR5/8x12	ATR5/8x12ZP	ATR5/8x12HDG	1
5/8 x 18	ATR5/8x18	ATR5/8x18ZP	ATR5/8x18HDG	1
5/8 x 24	ATR5/8x24	ATR5/8x24ZP	ATR5/8x24HDG	1
5/8 x 30	ATR5/8x30	—	—	1
5/8 x 36	ATR5/8x36	ATR5/8x36ZP	ATR5/8x36HDG	1
3/4 x 12	ATR3/4x12	ATR3/4x12ZP	ATR3/4x12HDG	1
3/4 x 18	ATR3/4x18	ATR3/4x18ZP	ATR3/4x18HDG	1
3/4 x 24	ATR3/4x24	ATR3/4x24ZP	ATR3/4x24HDG	1
3/4 x 36	ATR3/4x36	ATR3/4x36ZP	ATR3/4x36HDG	1
7/8 x 12	ATR7/8x12	ATR7/8x12ZP	ATR7/8x12HDG	1
7/8 x 18	ATR7/8x18	ATR7/8x18ZP	ATR7/8x18HDG	1
7/8 x 20	ATR7/8x20	—	—	1
7/8 x 24	ATR7/8x24	ATR7/8x24ZP	ATR7/8x24HDG	1
7/8 x 26	ATR7/8x26	—	—	1
7/8 x 36	ATR7/8x36	ATR7/8x36ZP	ATR7/8x36HDG	1
1 x 12	ATR1x12	ATR1x12ZP	ATR1x12HDG	1
1 x 18	ATR1x18	ATR1x18ZP	ATR1x18HDG	1
1 x 24	ATR1x24	ATR1x24ZP	ATR1x24HDG	1
1 x 36	ATR1x36	ATR1x36ZP	ATR1x36HDG	1

Adhesive Accessories

Speed Clean™
Dust Extraction System

Save time and money by drilling faster and cleaner. "Drill and Fill" while complying with OSHA silica-dust regulations.

Features

- Drills holes 20% faster than standard bits
- Eliminates "blow-brush-blow" cleaning — greatly reducing dust and cutting installation time by up to 50%

The Speed Clean DXS dust extraction system is a drilling system that reduces health risks from airborne silica dust caused by the hole-drilling and cleaning processes. The Speed Clean DXS system simultaneously drills and cleans holes using a hollow-centered bit for rebar doweling or anchoring threaded rod and is code listed for use with Simpson Strong-Tie® AT-XP®, SET-XP® and SET-3G™.

For more information on the OSHA silica-dust regulation:

go.strongtie.com/oshasilica.



Solid carbide cutters embedded in a steel head

Internal dust extraction channel

Drill bit sizes available to fit SDS-plus and SDS-Max rotohammers

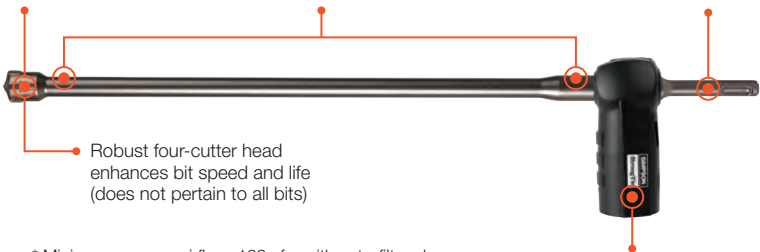

Robust four-cutter head enhances bit speed and life (does not pertain to all bits)

Rubber adapter connects drill bit shaft to vacuum hose

* Minimum vacuum airflow: 129 cfm with auto-filter cleaner. Maximum hammer no-load rpm: 760.

** Does not apply to 7/16", 1/2" and 9/16" drill bits.

Adhesive Accessories

Speed Clean™ DXS Dust Extraction Drill Bits
Code Tested with AT-XP®, SET-XP® and SET-3G™ Adhesives

Model No.	Description	Size (in.)	Drilling Depth (in.)	Threaded Rod Anchor (in.)	Rebar Anchor	Threaded Rod Anchor Products	Rebar Anchor Products	Carton Qty.
DXS-PL04313	SDS-plus®, 2 cutter	7/16 x 13	7 1/2	3/8	—	AT-XP and SET-3G	—	10
DXS-PL05013	SDS-plus, 2 cutter	1/2 x 13	7 1/2	3/8	#3	SET-XP	SET-XP, AT-XP and SET-3G	8
DXS-PL05615	SDS-plus, 2 cutter	9/16 x 15	10	1/2	—	AT-XP and SET-3G	—	8
DXS-PL06215Q	SDS-plus, 4 cutter	5/8 x 15	10	1/2	#4	SET-XP	SET-XP, AT-XP and SET-3G	8
DXS-PL06818Q	SDS-plus, 4 cutter	1 1/16 x 18	12 1/2	5/8	—	AT-XP and SET-3G	—	8
DXS-PL07518Q	SDS-plus, 4 cutter	3/4 x 18	12 1/2	5/8	#5	SET-XP	SET-XP, AT-XP and SET-3G	8
DXS-MX07521Q	SDS-max®, 4 cutter	3/4 x 21	12 1/2	5/8	#5	SET-XP	SET-XP, AT-XP and SET-3G	6
DXS-MX08125Q	SDS-max, 4 cutter	1 3/16 x 25	15	3/4	—	AT-XP	—	6
DXS-MX08725Q	SDS-max, 4 cutter	7/8 x 25	15	3/4	#6	SET-XP and SET-3G	SET-XP, AT-XP and SET-3G	6
DXS-MX10027Q	SDS-max, 4 cutter	1 x 27	17 1/2	7/8	#7	SET-XP, AT-XP and SET-3G	SET-XP, AT-XP and SET-3G	6
DXS-MX11229Q	SDS-max, 4 cutter	1 1/8 x 29	20	1	#8	SET-XP, AT-XP and SET-3G	SET-XP, AT-XP and SET-3G	6
DXS-MX13734Q	SDS-max, 4 cutter	1 3/8 x 34	25	1 1/4	#10	SET-XP, AT-XP and SET-3G	SET-XP, AT-XP and SET-3G	6

Speed Clean DXS Dust Extraction Adapters

Model No.	Description	Retail Package	Carton Quantity
DXS-MXADP	SDS-max adapter	1 adapter	10
DXS-PLADP	SDS-plus adapter	1 adapter	10

Adhesive Anchoring Installation Instructions



NOTE: Always check expiration date on product label. Do not use expired product.



WARNING: When drilling and cleaning hole, use eye and lung protection. When installing adhesive, use eye and skin protection.

1A Hole Preparation — Horizontal, Vertical and Overhead Applications (SET-XP®, AT-XP®, ET-HP® and SET)

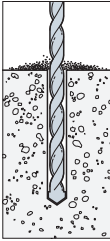

1. Drill.
Drill hole to specified diameter and depth.

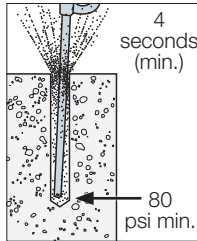

2. Blow.
Remove dust from hole with oil-free compressed air for a minimum of four seconds. Compressed air nozzle must reach the bottom of the hole.

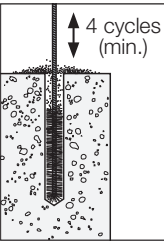

3. Brush.
Clean with a nylon brush for a minimum of four cycles. Brush should provide resistance to insertion. If no resistance is felt, the brush is worn and must be replaced.

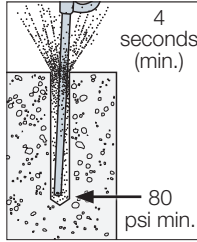

4. Blow.
Remove dust from hole with oil-free compressed air for a minimum of four seconds. Compressed air nozzle must reach the bottom of the hole.

Visit strongtie.com for proper brush part number.

Hole Preparation — Horizontal, Vertical and Overhead Applications (SET-3G™)

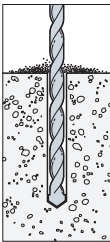

1. Drill.
Drill hole to specified diameter and depth.

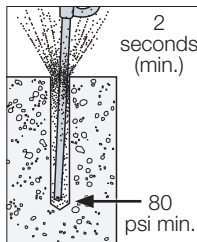

2. Blow.
Remove dust from hole with oil-free compressed air for a minimum of two seconds. Compressed air nozzle must reach the bottom of the hole..

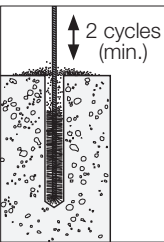

3. Brush.
Clean with a steel wire brush for a minimum of two cycles. Brush should provide resistance to insertion. If no resistance is felt, the brush is worn and must be replaced.

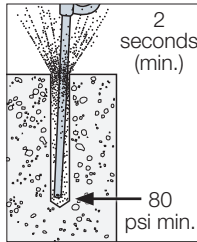

4. Blow.
Remove dust from hole with oil-free compressed air for a minimum of two seconds. Compressed air nozzle must reach the bottom of the hole.

Visit strongtie.com for proper brush part number.

Adhesive Anchoring Installation Instructions

1B Hole Preparation Vacuum Dust Extraction System with Bosch / Simpson Strong-Tie® DXS Hollow Carbide Drill Bit – Horizontal, Vertical and Overhead Applications

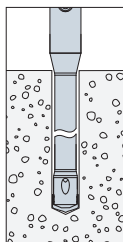

1. Drill.

Drill hole to specified diameter and depth using a Bosch / Simpson Strong-Tie DXS hollow carbide drill bit and vacuum dust extraction system.



Bosch / Simpson Strong-Tie DXS drill bit used with the vacuum dust extraction system.

2 Cartridge Preparation

1. Check.

Check expiration date on product label. **Do not use expired product.** Product is usable until end of printed expiration month.

2. Open.

Open cartridge per package instructions.

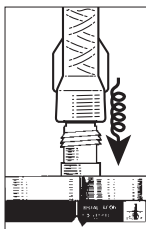

3. Attach.

Attach proper Simpson Strong-Tie® nozzle and extension to cartridge. Do not modify nozzle.

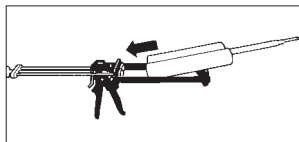

4. Insert.

Insert cartridge into dispensing tool.

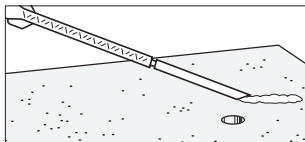

5. Dispense.

Dispense adhesive to the side until properly mixed (uniform color).

Refer to strongtie.com for proper mixing nozzle and dispensing tool part number.

Adhesive Anchoring Installation Instructions

FOR SOLID BASE MATERIALS

3A Filling the Hole — Vertical Anchorage

Prepare the hole per “Hole Preparation” instructions on product label.

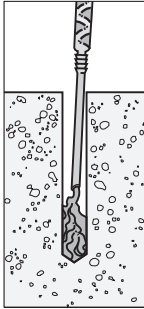
Dry and Damp Holes:**1. Fill.**

Fill hole $\frac{1}{2}$ to $\frac{2}{3}$ full, starting from bottom of hole to prevent air pockets. Withdraw nozzle as hole fills up.

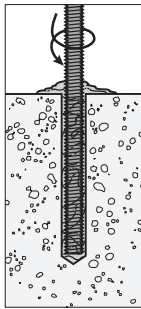
**2. Insert.**

Insert clean, oil-free anchor, turning slowly until the anchor contacts the bottom of the hole.

Threaded rod or rebar

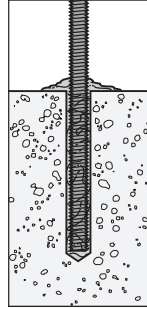
**3. Do not disturb.**

Do not disturb anchor until fully cured. (See cure schedule for specific adhesive.)

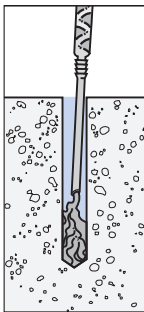
Water-Filled Holes:**1. Fill.**

Fill hole completely full, starting from bottom of hole to prevent water pockets. Withdraw nozzle as hole fills up.

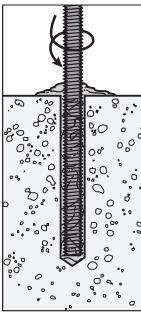
**2. Insert.**

Insert clean, oil-free anchor, turning slowly until the anchor contacts the bottom of the hole.

Threaded rod or rebar

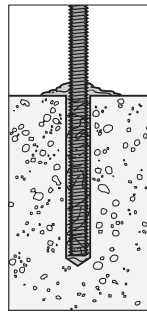
**3. Do not disturb.**

Do not disturb anchor until fully cured. (See cure schedule.)

Note: Nozzle extensions may be needed for deep holes.

Adhesive Anchoring Installation Instructions

3B Filling the Hole — Horizontal and Overhead Anchorage

Prepare the hole per "Hole Preparation" instructions on product label.

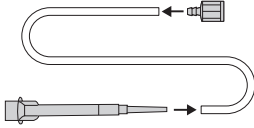
**Step 1:**

- Attach the piston plug to one end of the flexible tubing (PPFT25).
- Cut tubing to the length needed for the application, mark tubing as noted below and attach other end of tubing to the mixing nozzle.
- If using a pneumatic dispensing tool, regulate air pressure to 80–100 psi.

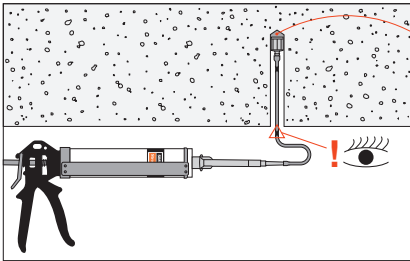
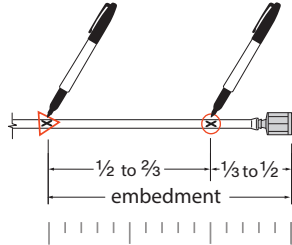
**Step 2:**

Insert the piston plug to the back of the drilled hole and dispense adhesive.

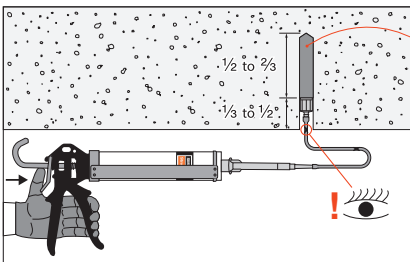
**Step 3:**

- Fill the hole $\frac{1}{2}$ to $\frac{2}{3}$ full
- **Note:** as adhesive is dispensed into the drilled hole, the piston plug will slowly displace out of the hole due to back pressure, preventing air gaps.

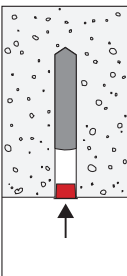

Step 4:
Install the appropriate Simpson Strong-Tie adhesive retaining cap.

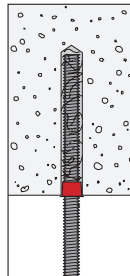
**Step 5:**

- Place either threaded rod or rebar through the adhesive retaining cap and into adhesive-filled hole.
- Turn rod/rebar slowly until the insert bottoms out.
- Do not disturb until fully cured.

Adhesive Anchoring Installation Instructions

FOR HOLLOW BASE MATERIALS

3C Filling the Hole —

When Anchoring with Screens — For AT-XP®, SET-XP® and SET Adhesives

Prepare the hole per "Hole Preparation" instructions on product label

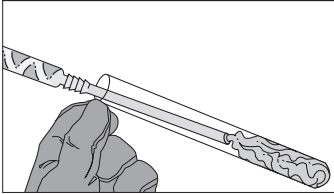
**1. Fill.**

Fill screen completely. Fill from the bottom of the screen and withdraw the nozzle as the screen fills to prevent air pockets. (Opti-Mesh screens: close integral cap after filling.)

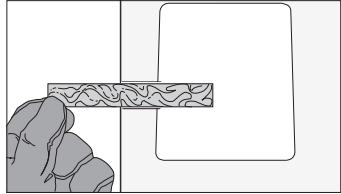
**2. Insert.**

Insert adhesive-filled screen into hole.

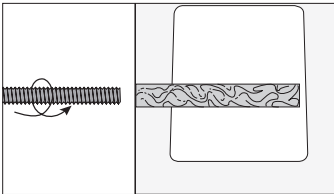
**3. Insert.**

Insert clean, oil-free anchor, turning slowly until the anchor contacts the bottom of the screen.

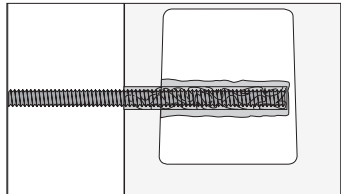
**4. Do not disturb.**

Do not disturb anchor until fully cured. (See cure schedule for specific adhesive.)

Adhesive Anchoring Installation Instructions

FOR UNREINFORCED BRICK MASONRY

1A Hole Preparation —

For Configurations A and C (Horizontal) and B (22½° Downward) Installations with a Carbide-Tipped Drill Bit.

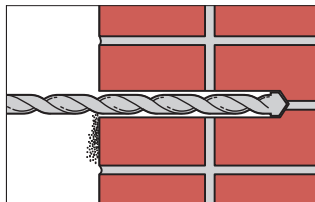
**1. Drill.**

Drill 1"-diameter hole to specified depth with a carbide-tipped drill bit, using rotation only mode. For Configurations A and C, drill 8" deep. For Configuration B, drill to within 1" of the opposite side of wall (minimum 13" deep).

**2. Blow.**

Remove dust from hole with oil-free compressed air for a minimum of four seconds. Compressed air nozzle **MUST** reach the bottom of the hole.

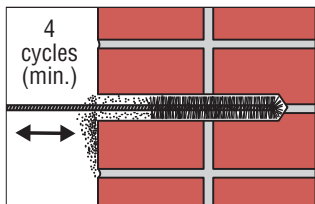
**3. Brush.**

Clean with a nylon brush for a minimum of four cycles. Brush **MUST** reach the bottom of the hole. Brush should provide resistance to insertion. If no resistance is felt, the brush is worn and must be replaced.

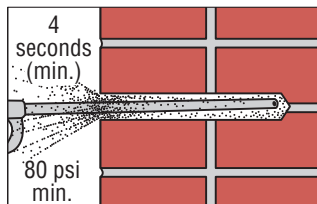
**4. Blow.**

Remove dust from hole with oil-free compressed air for a minimum of four seconds. Compressed air nozzle **MUST** reach the bottom of the hole.

Adhesive Anchoring Installation Instructions

1B Hole Preparation —

For using SET Adhesive Configurations A and C (Horizontal) and B (22½° Downward) Installations with a Wet Diamond Core-Drill Bit.

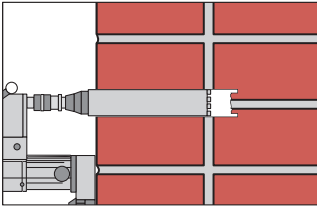
**1. Drill.**

Drill hole to specified depth with 1"-diameter wet diamond core-drill bit. For Configurations A and C, drill 8" deep. For Configuration B, drill to within 1" of the opposite side of wall (minimum 13" deep).

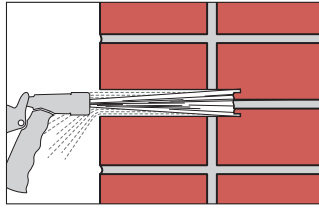
**2. Flush.**

Flush out hole with pressurized water until water runs clear.

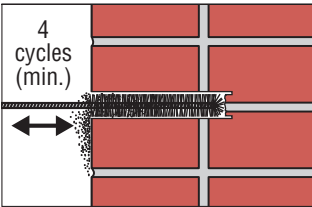
**3. Brush.**

Clean with a nylon brush (Simpson Strong-Tie part number ETB10) for a minimum of four brush strokes. Brush MUST reach the bottom of the hole. Brush should provide resistance to insertion. If no resistance is felt, the brush is worn and must be replaced.

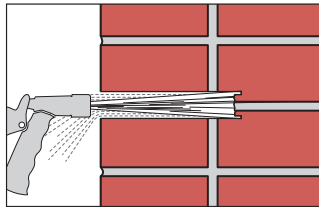
**4. Flush.**

Flush out hole with pressurized water until water runs clear.

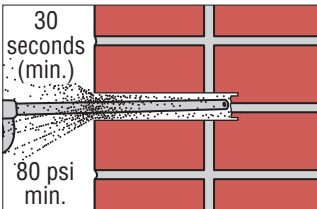
**5. Blow.**

Remove free standing water from hole with oil-free compressed air and blow out hole for a minimum of 30 seconds. Compressed air nozzle MUST reach the bottom of the hole.

Adhesive Anchoring Installation Instructions

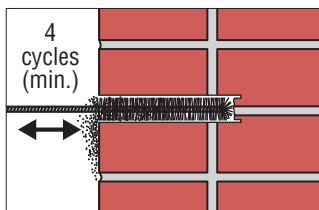
**6. Brush.**

Clean with a nylon brush (Simpson Strong-Tie part number ETB10) for a minimum of four brush strokes. Brush MUST reach the bottom of the hole. Brush should provide resistance to insertion. If no resistance is felt, the brush is worn and must be replaced.

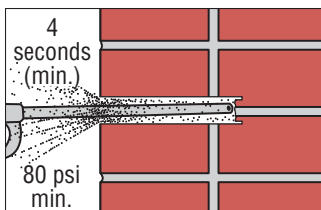
**7. Blow.**

Blow hole with oil-free compressed air for a minimum of four seconds. Compressed air nozzle MUST reach the bottom of the hole.

2 Cartridge Preparation

Reference p. 43 for cartridge preparation.

3 Filling the Hole —

For Configurations A (Horizontal) and B (22½° Downward) Installations.

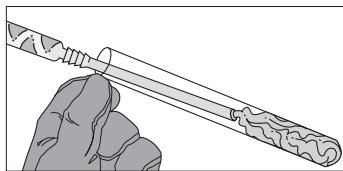
**1. Fill.**

Fill screen completely. Fill from the bottom of the screen and withdraw the nozzle as the screen fills to prevent air pockets.

**2. Insert.**

Insert adhesive filled screen into hole.

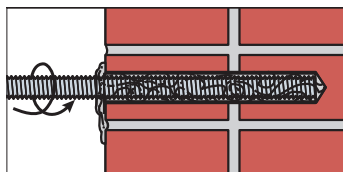
**3. Insert.**

Insert clean, oil-free anchor, turning slowly until the anchor contacts the bottom of the screen.

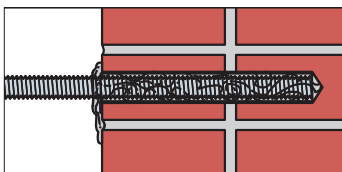
**4. Do not disturb.**

Do not disturb anchor until fully cured. (See cure schedule for specific adhesive.)

Note: Steel wire mesh screens may be used for Configurations A and B.



Mechanical Anchors

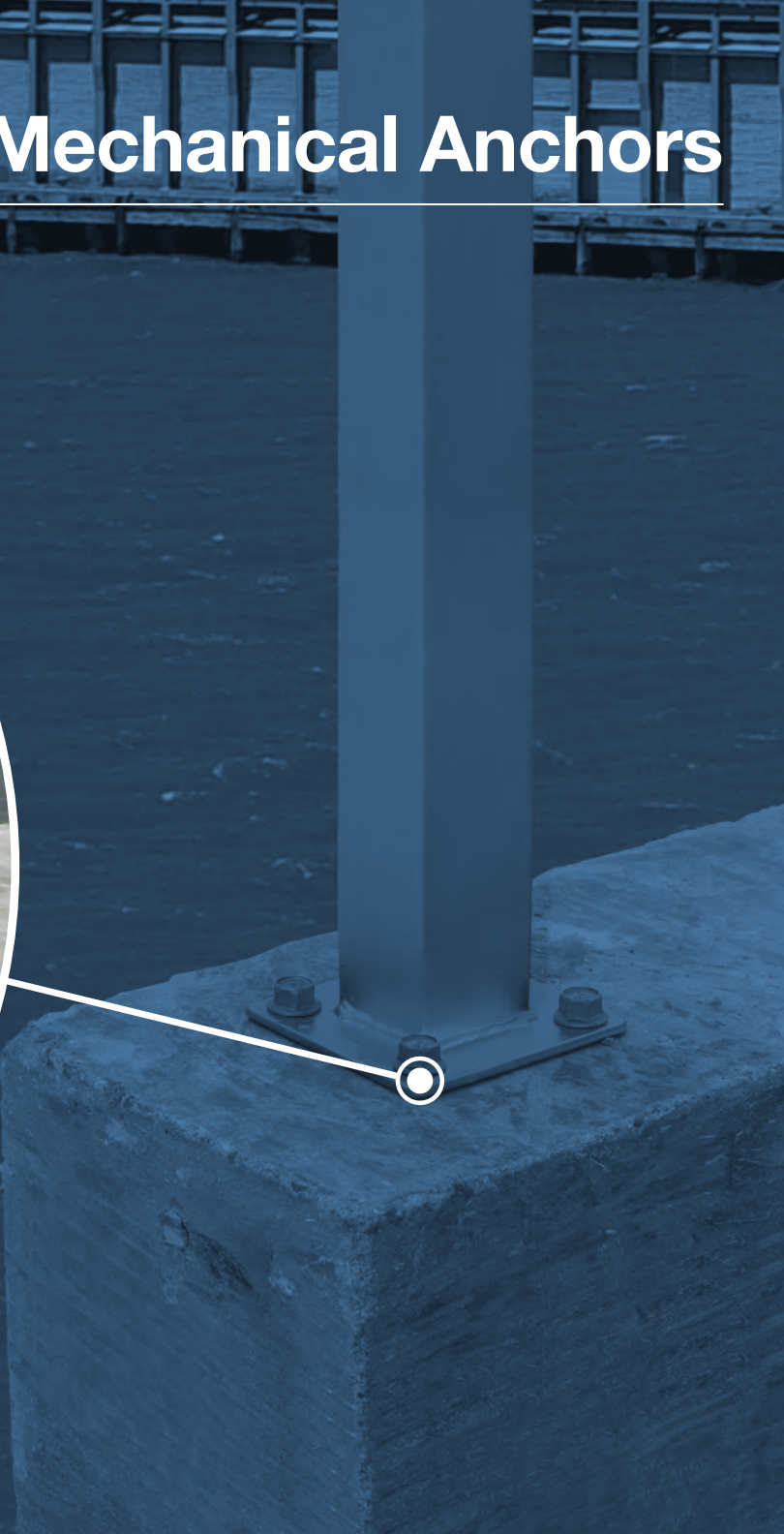

Titen HD® Heavy-Duty Screw Anchor

A high-strength screw anchor for use in cracked and uncracked concrete, as well as uncracked masonry. The Titen HD offers low installation torque and outstanding performance. Suitable in dry, interior, non-corrosive environments or temporary outdoor applications.



Features

- Qualified for static and seismic loading conditions.
- Standard fractional sizes.
- Specialized heat-treating process creates tip hardness for better cutting without compromising the ductility.
- No special drill bit required — designed to install using standard-sized ANSI tolerance drill bits.
- Hex-washer head requires no separate washer, unless required by code, and provides a clean installed appearance.
- Removable — ideal for temporary anchoring (e.g., formwork, bracing) or applications where fixtures may need to be moved. Reuse of the anchor to achieve listed load values is not recommended.



Codes: ICC-ES ESR-2713 (concrete); ICC-ES ESR-1056 (masonry); City of L.A. RR25741 (concrete), RR25560 (masonry); Florida FL-15730.6; FM 3017082, 3035761 and 3043442; Multiple DOT listings

Material: Carbon steel

Coating: Zinc plated or mechanically galvanized.

Not recommended for permanent exterior use or highly corrosive environments.

Installation

-  Holes in metal fixtures to be mounted should match the diameter specified in the table on p. 53. Use a Titen HD screw anchor one time only — installing the anchor multiple times may result in excessive thread wear and reduce load capacity.
 -  Do not use impact wrenches to install into hollow CMU.
 -  **Caution:** Oversized holes in base material will reduce or eliminate the mechanical interlock of the threads with the base material and reduce the anchor's load capacity.
1. Drill a hole in the base material using a carbide drill bit the same diameter as the nominal diameter of the anchor to be installed. Drill the hole to the specified embedment depth plus minimum hole depth overall (see table on p. 53) to allow the thread tapping dust to settle, and blow it clean using compressed air. (Overhead installations need not be blown clean.) Alternatively, drill the hole deep enough to accommodate embedment depth and the dust from drilling and tapping.
 2. Insert the anchor through the fixture and into the hole.
 3. Tighten the anchor into the base material until the hex-washer head contacts the fixture.



**Titen HD
Screw Anchor**

US Patent
6,623,228



Serrated teeth on the tip of the Titen HD® screw anchor facilitate cutting and reduce installation torque.

Titen HD® Heavy-Duty Screw Anchor

Installation Sequence

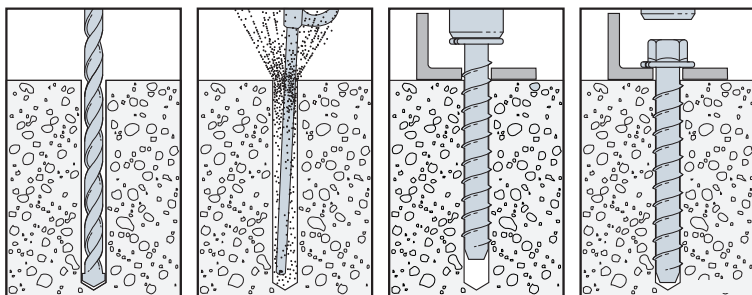

Additional Installation Information for Structural Steel

Titen HD® Diameter (in.)	Wrench Size (in.)	Recommended Steel Fixture Hole Size (in.)	Minimum Hole Depth Overdrill (in.)
1/4	3/8	3/8 to 7/16	1/8
3/8	9/16	1/2 to 9/16	1/4
1/2	3/4	5/8 to 11/16	1/2
5/8	15/16	3/4 to 13/16	1/2
3/4	1 1/8	7/8 to 15/16	1/2

Suggested fixture hole sizes are for structural steel thicker than 12 gauge only. Larger holes are not required for wood or cold-formed steel members.

Titen HD Anchor Product Data — Mechanically Galvanized

Size (in.)	Model No.	Drill Bit Diameter (in.)	Wrench Size (in.)	Quantity	
				Box	Carton
3/8 x 3	THD37300HMG	3/8	9/16	50	200
3/8 x 4	THD37400HMG			50	200
3/8 x 5	THD37500HMG			50	100
3/8 x 6	THD37600HMG			50	100
1/2 x 4	THD50400HMG	1/2	3/4	20	80
1/2 x 5	THD50500HMG			20	80
1/2 x 6	THD50600HMG			20	80
1/2 x 6 1/2	THD50612HMG			20	40
1/2 x 8	THD50800HMG			20	40
5/8 x 5	THDB62500HMG	5/8	15/16	10	40
5/8 x 6	THDB62600HMG			10	40
5/8 x 6 1/2	THDB62612HMG			10	40
5/8 x 8	THDB62800HMG			10	20
3/4 x 6	THDT75600HMG	3/4	1 1/8	5	20
3/4 x 8 1/2	THD75812HMG			5	10
3/4 x 10	THD75100HMG			5	10

Mechanical galvanizing meets ASTM B695, Class 65, Type 1 and is not covered under ICC-ES ESR-2713. Intended for some pressure-treated wood sill plate applications. Not for use in other corrosive or outdoor environments. Visit strongtie.com/info for more corrosion information.

Titen HD® Heavy-Duty Screw Anchor

Titen HD Anchor Product Data — Zinc Plated

Size (in.)	Model No.	Drill Bit Diameter (in.)	Wrench Size (in.)	Quantity	
				Box	Carton
¼ x 1½	THDB25178H	¼	¾	100	500
¼ x 2¾	THDB25234H	¼	¾	50	250
¼ x 3	THDB25300H	¼	¾	50	250
¼ x 3½	THDB25312H	¼	¾	50	250
¼ x 4	THDB25400H	¼	¾	50	250
¾ x 1¾	THD37134H†	¾	9/16	50	250
¾ x 2½	THD37212H†	¾	9/16	50	200
¾ x 3	THD37300H	¾	9/16	50	200
¾ x 4	THD37400H	¾	9/16	50	200
¾ x 5	THD37500H	¾	9/16	50	100
¾ x 6	THD37600H	¾	9/16	50	100
½ x 3	THD50300H	½	¾	25	100
½ x 4	THD50400H	½	¾	20	80
½ x 5	THD50500H	½	¾	20	80
½ x 6	THD50600H	½	¾	20	80
½ x 6½	THD50612H	½	¾	20	40
½ x 8	THD50800H	½	¾	20	40
½ x 12	THD501200H	½	¾	5	25
½ x 13	THD501300H	½	¾	5	25
½ x 14	THD501400H	½	¾	5	25
½ x 15	THD501500H	½	¾	5	25
⅝ x 4	THDB62400H	⅝	15/16	10	40
⅝ x 5	THDB62500H	⅝	15/16	10	40
⅝ x 6	THDB62600H	⅝	15/16	10	40
⅝ x 6½	THDB62612H	⅝	15/16	10	40
⅝ x 8	THDB62800H	⅝	15/16	10	20
⅝ x 10	THDB62100H	⅝	15/16	10	20
¾ x 4	THD75400H	¾	1 ⅛	10	40
¾ x 5	THD75500H	¾	1 ⅛	5	20
¾ x 6	THDT75600H	¾	1 ⅛	5	20
¾ x 7	THD75700H	¾	1 ⅛	5	10
¾ x 8½	THD75812H	¾	1 ⅛	5	10
¾ x 10	THD75100H	¾	1 ⅛	5	10

† These models do not meet minimum embedment depth requirements for strength design and require maximum installation torque of 25 ft.-lb. using a torque wrench, driver drill or cordless ¼" impact driver with a maximum permitted torque rating of 100 ft.-lb.



THDT75600H



THD75700H

Titen HD® Heavy-Duty Screw Anchor

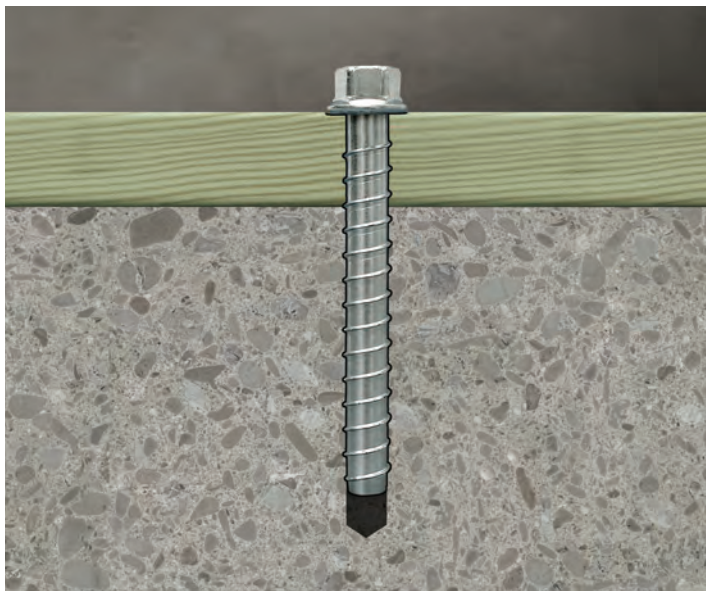

Mechanical Anchors



Stainless-Steel Titen HD® Heavy-Duty Screw Anchor

The Titen HD stainless-steel screw anchor for concrete and masonry sets the standard for when the job calls for installation in multiple types of environments. It is the ultimate choice to provide fast and efficient installation, combined with long-lasting corrosion resistance for an unsurpassed peace-of-mind.

Innovative — The serrated carbon-steel threads on the tip of the stainless-steel Titen HD are vital because they undercut the concrete as the anchor is driven into the hole, making way for the rest of the threads to interlock with the concrete.

Corrosion Resistant — For dry, interior applications, carbon-steel corrosion is not a risk, but in any kind of exterior, coastal or chemical environment the anchor would be susceptible to corrosion.

Features

- Ideal for exterior or corrosive environments
- Less carbon steel, less expansion
- Installs with an impact wrench or by hand tool

Codes: Code listed in IAPMO UES ER-493 (concrete) and ICC-ES ESR-1056 (masonry); tested per ACI355.2 and AC193

Material: Type 316 and Type 304 stainless steel with carbon-steel lead threads

Installation

Caution: Holes in steel fixtures to be mounted should match the diameter specified in the table on p. 57 if steel is thicker than 12 gauge.

Caution: Use a Titen HD screw anchor one time only — installing the anchor multiple times may result in excessive thread wear and reduce load capacity.

Do not use impact wrenches to install into hollow CMU.

Caution: Oversized holes in base material will reduce or eliminate the mechanical interlock of the threads with the base material and reduce the anchor's load capacity.

1. Drill a hole in the base material using a carbide drill bit (complying with ANSI B212.15) with the same diameter as the nominal diameter of the anchor to be installed. Drill the hole to the specified minimum hole depth overdrill (see table on p. 57) to allow the thread tapping dust to settle, and blow it clean using compressed air. (Overhead installations need not be blown clean.) Alternatively, drill the hole deep enough to accommodate embedment depth and the dust from drilling and tapping.
2. Insert the anchor through the fixture and into the hole.
3. Tighten the anchor into the base material until the hex-washer head contacts the fixture.

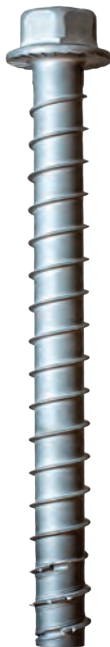

**Stainless-Steel
Titen HD
Screw Anchor**
US Patent 8,747,042 B2



Innovative carbon-steel thread effectively cuts the concrete while significantly limiting the amount of carbon steel in the anchor, minimizing the amount of corrosion potential that can occur in a exterior corrosive environment.

Stainless-Steel Titen HD® Heavy-Duty Screw Anchor

Installation Sequence

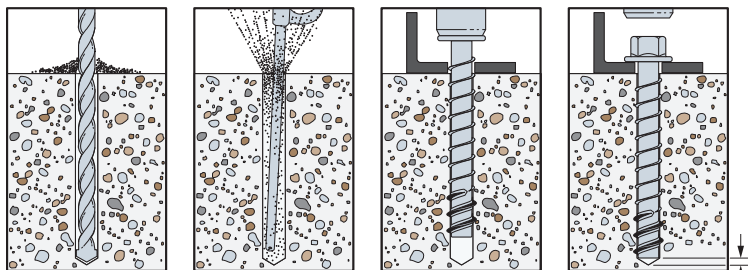

Additional Installation Information

Titen HD® Diameter (in.)	Wrench Size (in.)	Recommended Steel Fixture Hole Size (in.)	Minimum Hole Depth Overdrill (in.)
1/4	3/8	3/8 to 7/16	1/8
3/8	9/16	1/2 to 9/16	1/4
1/2	3/4	5/8 to 11/16	1/2
5/8	15/16	3/4 to 13/16	1/2
3/4	1 1/8	7/8 to 15/16	1/2

1/4" dia. = 1/8"
 3/8" dia. = 1/4"
 1/2", 5/8", 3/4" dia. = 1/2"

Suggested fixture hole sizes are for structural steel thicker than 12 gauge only. Larger holes are not required for wood or cold-formed steel members.

Stainless-Steel Titen HD Anchor Product Data

Size (in.)	Model No. (Type 316)	Model No. (Type 304)	Drill Bit Dia. (in.)	Wrench Size (in.)	Quantity	
					Box	Carton
1/4 x 2	THDC25200H6SS	—	1/4	3/8	50	250
1/4 x 2 3/8	THDC25238H6SS	—	1/4	3/8	50	250
1/4 x 3	THDC25300H6SS	—	1/4	3/8	50	250
1/4 x 4	THDC25400H6SS	—	1/4	3/8	50	250
3/8 x 3	THD37300H6SS	THD37300H4SS	3/8	9/16	50	200
3/8 x 4	THD37400H6SS	THD37400H4SS	3/8	9/16	50	200
3/8 x 5	THD37500H6SS	THD37500H4SS	3/8	9/16	50	100
3/8 x 6	THD37600H6SS	THD37600H4SS	3/8	9/16	50	100
1/2 x 3	THD50300H6SS	THD50300H4SS	1/2	3/4	25	100
1/2 x 4	THD50400H6SS	THD50400H4SS	1/2	3/4	20	80
1/2 x 5	THD50500H6SS	THD50500H4SS	1/2	3/4	20	80
1/2 x 6	THD50600H6SS	THD50600H4SS	1/2	3/4	20	80
1/2 x 6 1/2	THD50612H6SS	THD50612H4SS	1/2	3/4	20	40
1/2 x 8	THD50800H6SS	THD50800H4SS	1/2	3/4	20	40
5/8 x 4	THDB62400H6SS	THDB62400H4SS	5/8	15/16	10	40
5/8 x 5	THDB62500H6SS	THDB62500H4SS	5/8	15/16	10	40
5/8 x 6	THDB62600H6SS	THDB62600H4SS	5/8	15/16	10	40
5/8 x 6 1/2	THDB62612H6SS	THDB62612H4SS	5/8	15/16	10	40
5/8 x 8	THDB62800H6SS	THDB62800H4SS	5/8	15/16	10	20
3/4 x 4	THD75400H6SS	THD75400H4SS	3/4	1 1/8	10	40
3/4 x 5	THD75500H6SS	THD75500H4SS	3/4	1 1/8	5	20
3/4 x 6	THD75600H6SS	THD75600H4SS	3/4	1 1/8	5	20
3/4 x 7	THD75700H6SS	THD75700H4SS	3/4	1 1/8	5	10
3/4 x 8 1/2	THD75812H6SS	THD75812H4SS	3/4	1 1/8	5	10

Titen HD® Countersunk Screw Anchor

The countersunk head style is for applications that require a flush-mount profile. Countersinking also leaves a cleaner surface appearance for exposed through-set applications. The anchor head's 6-lobe drive eases driving and is less prone to stripping than traditional recessed anchor heads.

Features

- 6-lobe drive reduces driver-bit cam-outs, resulting in easier installation
- Countersunk head allows screw anchor applications incompatible with a hex head
- Qualified for static and seismic loading conditions
- Standard fractional sizes, hole size same as anchor size
- No special drill bit required — designed to install using standard-sized ANSI tolerance drill bits
- Removable — ideal for temporary anchoring or applications where fixtures may need to be moved
- Available in many of the same lengths as standard THD in ¼" and ⅜" diameters
- Driver bit included in each box



Codes: ICC-ES ESR-2713 (concrete);
ICC-ES ESR-1056 (masonry)

Material: Carbon steel

Coating: Zinc plated

Not recommended for permanent exterior use or highly corrosive environments.

Installation

-  Holes in metal fixtures to be mounted should match the diameter specified in the table on p. 59. Use a Titen HD screw anchor one time only — installing the anchor multiple times may result in excessive thread wear and reduce load capacity.
 -  Do not use impact wrenches to install into hollow CMU.
 -  **Caution:** Oversized holes in base material will reduce or eliminate the mechanical interlock of the threads with the base material and reduce the anchor's load capacity.
1. Drill a hole in the base material using a carbide drill bit the same diameter as the nominal diameter of the anchor to be installed. Drill the hole to the specified embedment depth plus minimum hole depth overall (see table on p. 59) to allow the thread tapping dust to settle, and blow it clean using compressed air. (Overhead installations need not be blown clean.) Alternatively, drill the hole deep enough to accommodate embedment depth and the dust from drilling and tapping.
 2. Insert the anchor through the fixture and into the hole.
 3. Tighten the anchor into the base material until the countersunk head contacts the fixture.



**Titen HD
Countersunk
Screw Anchor**

US Patent
6,623,228



6-lobe drive reduces driver-bit cam-outs, resulting in easier installation

Titen HD® Countersunk Screw Anchor

Installation Sequence

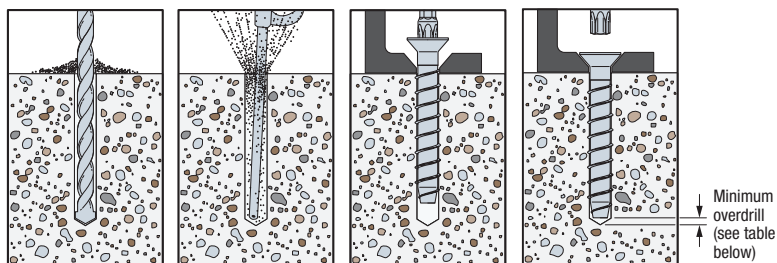

Additional Installation Information for Structural Steel

Titen HD Diameter (in.)	Bit Size	Recommended Steel Fixture Hole Size (in.)	Minimum Hole Depth Overdrill (in.)
1/4	T30	3/8 – 7/16	1/8
3/8	T50	1/2 – 9/16	1/4

Suggested fixture hole sizes are for structural steel thicker than 12 gauge only. Larger holes are not required for wood or cold-formed steel members.

Titen HD Screw Anchor Product Data — Countersunk Head

Size (in.)	Model No.	Drill Bit Diameter (in.)	Bit Size	Box Quantity	Carton Quantity
1/4 x 1 1/8	THDB25178CS	1/4	T30	100	500
1/4 x 2 3/4	THDB25234CS	1/4	T30	50	250
1/4 x 3 1/2	THDB25312CS	1/4	T30	50	250
1/4 x 4 1/2	THDB25412CS	1/4	T30	50	250
3/8 x 2 1/2	THD37212CS†	3/8	T50	50	200
3/8 x 3	THD37300CS	3/8	T50	50	200
3/8 x 4	THD37400CS	3/8	T50	50	200
3/8 x 5	THD37500CS	3/8	T50	50	100

† This model does not meet minimum embedment depth requirements for strength design and requires a maximum installation torque of 25 ft.-lb. using a torque wrench, driver drill or cordless 1/4" impact driver with a maximum permitted torque rating of 100 ft.-lb.

For additional load information, see strongtie.com.

Titen HD® Rod Coupler

The Titen HD rod coupler is designed to be used in conjunction with a single or multi-story rod tie-down system. This anchor provides a fast and simple way to attach threaded rod to a concrete stem wall or thickened slab footing. Unlike adhesive anchors, the installation requires no special tools, cure time or secondary setting process; just drill a hole and drive the anchor.

Features

- The serrated cutting teeth and patented thread design enable the Titen HD rod coupler to be installed quickly and easily. Less installation time translates to lower installed cost.
- The specialized heat treating process creates tip hardness to facilitate cutting while the body remain ductile.
- No special setting tools required. ANSI size bits and standard sockets.
- Compatible with threaded rods in $\frac{3}{8}$ " and $\frac{1}{2}$ " diameters.

Material: Carbon steel

Coating: Zinc plated

Installation

Caution: Oversized holes in the base material will reduce or eliminate the mechanical interlock of the threads with base material and will reduce the anchor's load capacity. Use a Titen HD Rod Coupler one time only. Installing the anchor multiple times may result in excessive thread wear and reduce load capacity.

1. Drill a hole using the specified diameter carbide bit into the base material to a depth of at least $\frac{1}{2}$ " deeper than the required embedment.
2. Blow the hole clean of dust and debris using compressed air. Overhead application need not be blown clean.
3. Tighten the anchor with appropriate size socket until the head sits flush against base material.



**Titen HD
Rod Coupler**
US Patent
6,623,228

Titen HD® Rod Coupler

Installation Sequence

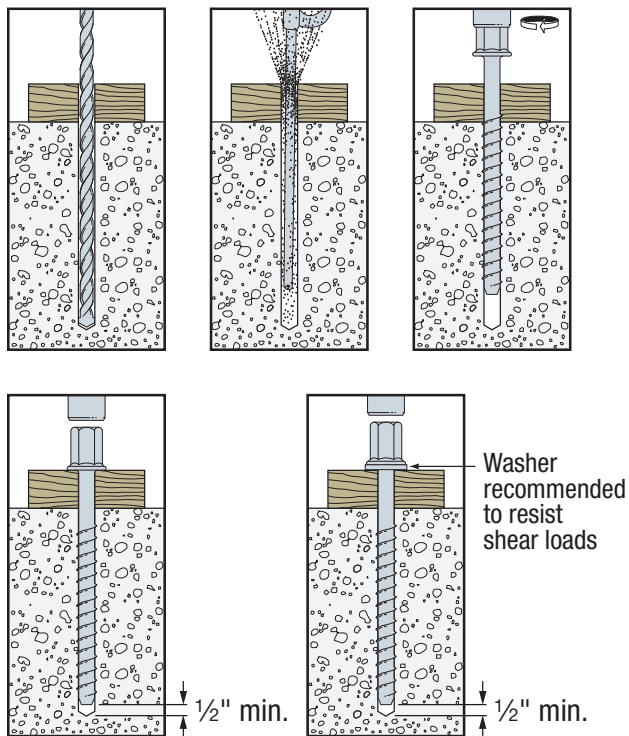

Titen HD Rod Coupler Product Data

Size (in.)	Model No.	Accepts Rod Diameter (in.)	Drill Bit Diameter (in.)	Wrench Size (in.)	Quantity	
					Box	Carton
3/8 x 6 3/4	THD37634RC	3/8	3/8	9/16	50	100
1/2 x 9 3/4	THD50934RC	1/2	1/2	3/4	20	40

Strong-Bolt® 2 Wedge Anchor

Code listed for cracked and uncracked concrete, and masonry applications, the STB2 wedge-type expansion anchor is an optimal choice for high-performance even in seismic and high-wind conditions. Dual undercutting embossments on each clip segment enable secondary expansion should a crack form and intersect the anchor location; this feature significantly increases the ability of the STB2 to carry load if the hole expands. The STB2 has a chamfered top designed to prevent mushrooming during installation, and to ensure the nut can be easily installed/removed.

Features

- Suitable for horizontal, vertical and overhead applications
- Qualified for minimum concrete thickness of 3¼", and lightweight concrete-over-metal deck thickness of 2½" and 3¼"
- Fits standard (ANSI) fixtures and installs with common drill bit and tool sizes

Codes: Code listed under IBC/IRC for cracked and uncracked concrete per ICC-ES ESR-3037; Code listed under IBC/IRC for masonry per IAPMO UES ER-240; Qualified for static and seismic loading conditions (seismic design categories A through F); ICC-ES ESR-3037 (concrete); IAPMO UES ER-240 (carbon steel in CMU); City of L.A. RR25891 (concrete), RR25936 (carbon steel in CMU); Florida FL-15731.2; FL-16230.4; UL File Ex3605; FM 3043342 and 3047639; Multiple DOT listings; meets the requirements of Federal Specifications A-A-1923A, Type 4

Material: Carbon steel, Type 304 and Type 316 stainless steel



Head Stamp

The head is stamped with the length identification letter, bracketed top and bottom by horizontal lines.





Strong-Bolt 2 Wedge Anchor

Material Specifications

Anchor Body	Nut	Washer	Clip
Carbon steel	Carbon steel, ASTM A 563, Grade A	Carbon steel, ASTM F844	Carbon steel, ASTM A 568
Type 304 stainless steel	Type 304 stainless steel	Type 304 stainless steel	Type 304 or 316 stainless steel
Type 316 stainless steel	Type 316 stainless steel	Type 316 stainless steel	Type 316 stainless steel

Strong-Bolt® 2 Wedge Anchor

Installation

-  Do not use an impact wrench to set or tighten the Strong-Bolt 2 anchor.
-  **Caution:** Oversized holes in the base material will make it difficult to set the anchor and will reduce the anchor's load capacity.

1. Drill a hole in the base material using a carbide drill bit the same diameter as the nominal diameter of the anchor to be installed. Drill the hole to the specified minimum hole depth, and blow it clean using compressed air. (Overhead installations need not be blown clean.) Alternatively, drill the hole deep enough to accommodate embedment depth and dust from drilling.
2. Assemble the anchor with nut and washer so the top of the nut is flush with the top of the anchor. Place the anchor in the fixture, and drive it into the hole until the washer and nut are tight against the fixture.
3. Tighten to the required installation torque.

Installation Sequence

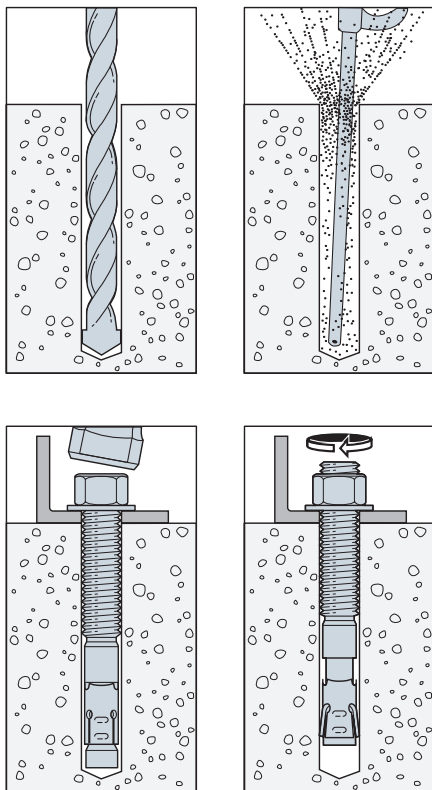

Strong-Bolt® 2 Wedge Anchor

Strong-Bolt 2 Anchor Installation Data

Strong-Bolt 2 Diameter (in.)	¼	⅜	½	⅝	¾	1
Drill bit size (in.)	¼	⅜	½	⅝	¾	1
Min. fixture hole (in.)	⅝	⅞	⅞	1⅛	⅞	1⅛
Wrench size (in.)	⅞	⅞	¾	1⅝	1⅞	1½
Concrete installation torque (ft.-lbf.) Carbon steel	4	30	60	90	150	230
Concrete installation torque (ft.-lbf.) Stainless steel	4	30	65	80	150	—

Length Identification Head Marks on Strong-Bolt 2 Wedge Anchors
(corresponds to length of anchor — inches)

Mark	Units	A	B	C	D	E	F	G	H	I	J	K	L	M
From	in.	1½	2	2½	3	3½	4	4½	5	5½	6	6½	7	7½
Up To But Not Including	in.	2	2½	3	3½	4	4½	5	5½	6	6½	7	7½	8

Mark	Units	N	O	P	Q	R	S	T	U	V	W	X	Y	Z
From	in.	8	8½	9	9½	10	11	12	13	14	15	16	17	18
Up To But Not Including	in.	8½	9	9½	10	11	12	13	14	15	16	17	18	19

Strong-Bolt® 2 Wedge Anchor

Strong-Bolt 2 Anchor Product Data

Size (in.)	Carbon Steel Model No.	Type 304 Stainless Steel Model No.	Type 316 Stainless Steel Model No.	Drill Bit Diameter (in.)	Thread Length (in.)	Quantity	
						Box	Carton
¼ x 1¾	STB2-25134	STB2-251344SS	STB2-251346SS	¼	1½	100	500
¼ x 2¼	STB2-25214	STB2-252144SS	STB2-252146SS	¼	17/16	100	500
¼ x 3¼	STB2-25314	STB2-253144SS	STB2-253146SS	¼	27/16	100	500
⅜ x 2¾	STB2-37234	STB2-372344SS	STB2-372346SS	⅜	1½	50	250
⅜ x 3	STB2-37300	STB2-373004SS	STB2-373006SS	⅜	1½	50	250
⅜ x 3½	STB2-37312	STB2-373124SS	STB2-373126SS	⅜	21/16	50	250
⅜ x 3¾	STB2-37334	STB2-373344SS	STB2-373346SS	⅜	25/16	50	250
⅜ x 5	STB2-37500	STB2-375004SS	STB2-375006SS	⅜	39/16	50	200
⅜ x 7	STB2-37700	STB2-377004SS	STB2-377006SS	⅜	59/16	50	200
½ x 3¾	STB2-50334	STB2-503344SS	STB2-503346SS	½	21/16	25	125
½ x 4¼	STB2-50414	STB2-504144SS	STB2-504146SS	½	29/16	25	100
½ x 4¾	STB2-50434	STB2-504344SS	STB2-504346SS	½	31/16	25	100
½ x 5½	STB2-50512	STB2-505124SS	STB2-505126SS	½	313/16	25	100
½ x 7	STB2-50700	STB2-507004SS	STB2-507006SS	½	59/16	25	100
½ x 8½	STB2-50812	STB2-508124SS	STB2-508126SS	½	6	25	50
½ x 10	STB2-50100	STB2-501004SS	STB2-501006SS	½	6	25	50
⅝ x 4½	STB2-62412	STB2-624124SS	STB2-624126SS	⅝	27/16	20	80
⅝ x 5	STB2-62500	STB2-625004SS	STB2-625006SS	⅝	215/16	20	80
⅝ x 6	STB2-62600	STB2-626004SS	STB2-626006SS	⅝	315/16	20	80
⅝ x 7	STB2-62700	STB2-627004SS	STB2-627006SS	⅝	415/16	20	80
⅝ x 8½	STB2-62812	STB2-628124SS	STB2-628126SS	⅝	6	20	40
⅝ x 10	STB2-62100	STB2-621004SS	STB2-621006SS	⅝	6	10	20
¾ x 5½	STB2-75512	STB2-755124SS	STB2-755126SS	¾	39/16	10	40
¾ x 6¼	STB2-75614	STB2-756144SS	STB2-756146SS	¾	315/16	10	40
¾ x 7	STB2-75700	STB2-757004SS	STB2-757006SS	¾	411/16	10	40
¾ x 8½	STB2-75812	STB2-758124SS	STB2-758126SS	¾	6	10	20
¾ x 10	STB2-75100	—	—	¾	6	10	20
1 x 7	STB2-100700	—	—	1	3½	5	20
1 x 10	STB2-1001000	—	—	1	3½	5	10
1 x 13	STB2-1001300	—	—	1	3½	5	10

Wedge-All® Wedge Anchor

The Wedge-All wedge-style expansion anchor is intended for use in solid concrete or grout-filled masonry. This anchor is best suited in installations where a building code approval for seismic and cracked/uncracked concrete is not required. Threaded studs are set by tightening the nut to the specified torque.

Features

- One-piece, wrap-around clip ensures uniform holding capacity
- Threaded end is chamfered for ease of starting nut

Codes: ICC-ES ESR-1396 (CMU); Florida FL-15730.7; FM 3017082 and 3131136; UL File Ex3605; Multiple DOT listings; meets the requirements of Federal Specification A-A-1923A, Type 4

Material: Carbon or stainless steel (Types 303/304; Type 316)

Coating: Carbon steel anchors are available zinc plated or mechanically galvanized

Installation

 Do not use an impact wrench to set or tighten anchors.

 **Caution:** Oversized holes in the base material will make it difficult to set the anchor and will reduce the anchor's load capacity.

1. Drill a hole in base material using a carbide drill bit the same diameter as the nominal diameter of the anchor to be installed. Drill the hole to the specified embedment depth, and blow it clean using compressed air. (Overhead installations need not be blown clean.) Alternatively, drill the hole deep enough to accommodate the embedment depth and the dust from drilling.
2. Assemble the anchor with nut and washer so the top of the nut is flush with the top of the anchor. Place the anchor in the fixture, and drive it into the hole until the washer and nut are tight against the fixture.
3. Tighten to the required installation torque.

Installation Sequence

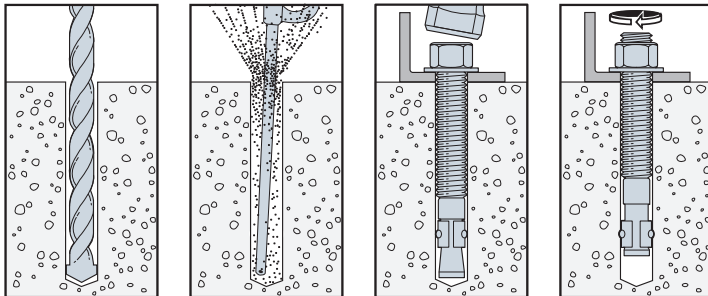

Head Stamp

The head is stamped with the length identification letter.



Wedge-All
Anchor

Wedge-All® Wedge Anchor

Wedge-All Anchor Installation Data

Wedge-All Diameter (in.)	¼	⅜	½	⅝	¾	⅞	1	1¼
Drill bit size (in.)	¼	⅜	½	⅝	¾	⅞	1	1¼
Min. fixture hole (in.)	⅝ ₁₆	7 ₁₆	9 ₁₆	11 ₁₆	7 ₈	1	1 1 ₈	1 3 ₈
Wrench size (in.)	7 ₁₆	9 ₁₆	¾	15 ₁₆	1 1 ₈	1 5 ₁₆	1 1 ₂	1 7 ₈

Material Specifications

Carbon Steel — Zinc Plated			
Component Materials			
Anchor Body	Nut	Washer	Clip
Material meets minimum 70,000 psi tensile strength	Carbon steel ASTM A 563, Grade A	Carbon steel	Carbon steel

Material Specifications

Carbon Steel — Mechanically Galvanized ¹			
Component Materials			
Anchor Body	Nut	Washer	Clip
Material meets minimum 70,000 psi tensile strength	Carbon steel ASTM A 563, Grade A	Carbon steel	Carbon steel

1. Mechanical galvanizing meets ASTM B695, Class 55, Type 1.

Material Specifications

Type 303/304 Stainless Steel ¹			
Component Materials			
Anchor Body	Nut	Washer	Clip
Type 303 or 304 stainless steel	Type 304 stainless steel	Type 304 stainless steel	Type 304 or 316 stainless steel

1. Types 303 and 304 stainless steels perform equally well in certain corrosive environments. Larger sizes are manufactured from Type 303.

Material Specifications

Type 316 Stainless Steel ¹			
Component Materials			
Anchor Body	Nut	Washer	Clip
Type 316 stainless steel	Type 316 stainless steel	Type 316 stainless steel	Type 316 stainless steel

1. Type 316 stainless steel provides the greatest degree of corrosion resistance offered by Simpson Strong-Tie.

Length Identification Head Marks on Wedge-All Anchors
(corresponds to length of anchor — inches)

Mark	A	B	C	D	E	F	G	H	I	J	K	L	M	N	O	P	Q	R	S	T	U	V	W	X	Y	Z
From	1½	2	2½	3	3½	4	4½	5	5½	6	6½	7	7½	8	8½	9	9½	10	11	12	13	14	15	16	17	18
Up To But Not Including	2	2½	3	3½	4	4½	5	5½	6	6½	7	7½	8	8½	9	9½	10	11	12	13	14	15	16	17	18	19

Wedge-All® Wedge Anchor

Wedge-All Anchor Product Data — Carbon Steel:
Zinc Plated and Mechanically Galvanized

Size (in.)	Zinc Plated Model No.	Mechanically Galvanized Model No.	Drill Bit Dia. (in.)	Thread Length (in.)	Quantity	
					Box	Carton
¼ x 2¼	—	WA25214MG	¼	1 ⁷ / ₁₆	100	500
¼ x 3¼	—	WA25314MG		2 ⁷ / ₁₆	100	500
⅜ x 2¼	WA37214	WA37214MG	⅜	1 ¹ / ₈	50	250
⅜ x 2¾	WA37234	WA37234MG		1 ⁵ / ₈	50	250
⅜ x 3	WA37300	WA37300MG		1 ⁷ / ₈	50	250
⅜ x 3½	WA37312	WA37312MG		2 ¹ / ₂	50	250
⅜ x 3¾	WA37334	WA37334MG		2 ⁵ / ₈	50	250
⅜ x 5	WA37500	WA37500MG		3 ⁷ / ₈	50	200
⅜ x 7	WA37700	WA37700MG		5 ⁷ / ₈	50	200
½ x 2¾	WA50234	WA50234MG		½	1 ⁵ / ₁₆	25
½ x 3¾	WA50334	WA50334MG	2 ⁵ / ₁₆		25	125
½ x 4¼	WA50414	WA50414MG	2 ¹³ / ₁₆		25	100
½ x 5½	WA50512	WA50512MG	4 ¹ / ₁₆		25	100
½ x 7	WA50700	WA50700MG	4 ⁹ / ₁₆		25	100
½ x 8½	WA50812	WA50812MG	6		25	50
½ x 10	WA50100	WA50100MG	6		25	50
½ x 12	WA50120	WA50120MG	6		25	50
⅝ x 3½	WA62312	WA62312MG	⅝	1 ⁷ / ₈	20	80
⅝ x 4½	WA62412	WA62412MG		2 ⁷ / ₈	20	80
⅝ x 5	WA62500	WA62500MG		3 ³ / ₈	20	80
⅝ x 6	WA62600	WA62600MG		4 ³ / ₈	20	80
⅝ x 7	WA62700	WA62700MG		5 ³ / ₈	20	80
⅝ x 8½	WA62812	WA62812MG		6	20	40
⅝ x 10	WA62100	WA62100MG		6	10	20
⅝ x 12	WA62120	WA62120MG		6	10	20
¾ x 4¼	WA75414	WA75414MG	¾	2 ³ / ₈	10	40
¾ x 4¾	WA75434	WA75434MG		2 ⁷ / ₈	10	40
¾ x 5½	WA75512	WA75512MG		3 ³ / ₈	10	40
¾ x 6¼	WA75614	WA75614MG		4 ³ / ₈	10	40
¾ x 7	WA75700	WA75700MG		5 ¹ / ₈	10	40
¾ x 8½	WA75812	WA75812MG		6	10	20
¾ x 10	WA75100	WA75100MG		6	10	20
¾ x 12	WA75120	WA75120MG		6	5	10
7⁄8 x 6	WA87600	WA87600MG	7⁄8	2 ¹ / ₈	5	20
7⁄8 x 8	WA87800	WA87800MG		2 ¹ / ₈	5	10
7⁄8 x 10	WA87100	WA87100MG		2 ¹ / ₈	5	10
7⁄8 x 12	WA87120	WA87120MG		2 ¹ / ₈	5	10
1 x 6	WA16000	WA16000MG	1	2 ¹ / ₄	5	20
1 x 9	WA19000	WA19000MG		2 ¹ / ₄	5	10
1 x 12	WA11200	WA11200MG		2 ¹ / ₄	5	10
1¼ x 9	WA12590	—		2 ³ / ₄	5	10
1¼ x 12	WA12512	—	1¼	2 ³ / ₄	5	10

1. The published length is the overall length of the anchor. Allow one anchor diameter for the nut and washer thickness plus the fixture thickness when selecting the minimum length.

Wedge-All® Wedge Anchor

Wedge-All Anchor Product Data — Stainless Steel

Size (in.)	Type 303/304 Stainless Model No. ²	Type 316 Stainless Model No.	Drill Bit Dia. (in.)	Thread Length (in.)	Quantity	
					Box	Carton
3/8 x 2 1/4	WA372144SS	WA372146SS	3/8	1 1/8	50	250
3/8 x 2 3/4	WA372344SS	WA372346SS		1 5/8	50	250
3/8 x 3	WA373004SS	WA373006SS		1 7/8	50	250
3/8 x 3 1/2	WA373124SS	WA373126SS		2 1/2	50	250
3/8 x 3 3/4	WA373344SS	WA373346SS		2 5/8	50	250
3/8 x 5	WA375004SS	WA375006SS		3 3/8	50	200
3/8 x 7	WA377004SS	WA377006SS		5 7/8	50	200
1/2 x 2 3/4	WA502344SS	WA502346SS	1/2	1 9/16	25	125
1/2 x 3 3/4	WA503344SS	WA503346SS		2 5/16	25	125
1/2 x 4 1/4	WA504144SS	WA504146SS		2 13/16	25	100
1/2 x 5 1/2	WA505124SS	WA505126SS		4 1/16	25	100
1/2 x 7	WA507004SS	WA507006SS		5 9/16	25	100
1/2 x 8 1/2	WA508124SS	WA508126SS		2	25	50
1/2 x 10	WA50100SS	—		2	25	50
1/2 x 12	WA50120SS	—	2	25	50	
5/8 x 3 1/2	WA623124SS	WA623126SS	5/8	1 7/8	20	80
5/8 x 4 1/2	WA624124SS	WA624126SS		2 7/8	20	80
5/8 x 5	WA625004SS	WA625006SS		3 3/8	20	80
5/8 x 6	WA626004SS	WA626006SS		4 3/8	20	80
5/8 x 7	WA627004SS	WA627006SS		5 3/8	20	80
5/8 x 8 1/2	WA628124SS	WA628126SS		2	20	40
5/8 x 10	WA62100SS	WA621003SS		2	10	20
5/8 x 12	WA62120SS	WA621203SS	2	10	20	
3/4 x 4 1/4	WA754144SS	WA754146SS	3/4	2 3/8	10	40
3/4 x 4 3/4	WA754344SS	WA754346SS		2 7/8	10	40
3/4 x 5 1/2	WA755124SS	WA755126SS		3 3/8	10	40
3/4 x 6 1/4	WA756144SS	WA756146SS		4 3/8	10	40
3/4 x 7	WA757004SS	WA757006SS		5 1/8	10	40
3/4 x 8 1/2	WA758124SS	WA758126SS		2 1/4	10	20
3/4 x 10	WA75100SS	WA751003SS		2 1/4	10	20
3/4 x 12	WA75120SS	WA751203SS	2 1/4	5	10	
7/8 x 6	WA87600SS	WA876003SS	7/8	2 1/8	5	20
7/8 x 8	WA87800SS	WA878003SS		2 1/8	5	10
7/8 x 10	WA87100SS	WA871003SS		2 1/8	5	10
7/8 x 12	WA87120SS	—		2 1/8	5	10
1 x 6	WA16000SS	WA160003SS	1	2 1/4	5	20
1 x 9	WA19000SS	WA190003SS		2 1/4	5	10
1 x 12	WA11200SS	WA112003SS		2 1/4	5	10

1. The published length is the overall length of the anchor. Allow one anchor diameter for the nut and washer thickness plus the fixture thickness when selecting a length.
2. Anchors with the "SS" suffix in the model number are manufactured from Type 303 stainless steel; the remaining anchors (with the "4SS" suffix) are manufactured from Type 304 stainless steel. Types 303 and 304 stainless steel perform equally well in certain corrosive environments.

Sleeve-All® Sleeve Anchor

Sleeve-All expanding anchors are pre-assembled, expanding sleeve anchors for use in all types of solid base materials. This anchor is available in acorn, hex, rod coupler, flat or round head style for a wide range of applications.

Codes: Factory Mutual 3017082, 3026805 and 3029959 ($\frac{3}{8}$ " – $\frac{1}{2}$ " diameter); Underwriters Laboratories File Ex3605 ($\frac{3}{8}$ " – $\frac{3}{4}$ " diameter); Multiple DOT listings; meets the requirements of Federal Specification A-A-1922A

Material: Carbon steel or stainless steel

Coating: Carbon steel anchors are zinc plated

Installation

1. Drill a hole in the base material using a carbide drill bit the same diameter as the nominal diameter of the anchor to be installed.
2. Drill the hole to the specified embedment depth, and blow it clean using compressed air. (Overhead installations need not be blown clean.) Alternatively, drill the hole deep enough to accommodate embedment depth and the dust from drilling.
3. Place the anchor in the fixture, and drive it into the hole until the washer and nut are tight against the fixture.
4. Tighten to required installation torque.

Caution: Oversized holes will make it difficult to set the anchor and will reduce the anchor's load capacity.



Installation Sequence

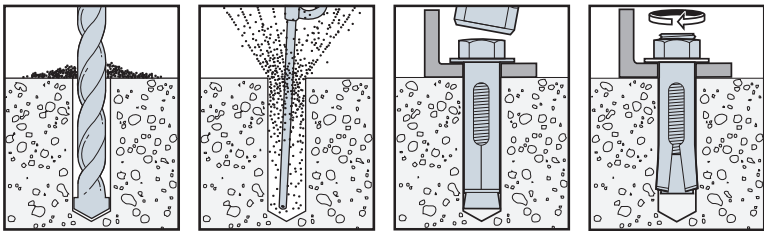

Sleeve-All® Sleeve Anchor

Material Specifications

Anchor Component	Zinc-Plated Carbon Steel	304 Stainless Steel
Anchor body	Material meets minimum 50,000 psi tensile	Type 304
Sleeve	SAE J403, Grade 1008 cold-rolled steel	Type 304
Nut	Commercial Grade, meets requirements of ASTM A563 Grade A	Type 304
Washer	SAE J403, Grade 1008/1010 cold-rolled steel	Type 304

Sleeve-All Anchor Installation Data

Sleeve-All Diameter (in.)	1/4	5/16	3/8	1/2	5/8	3/4
Installation torque (ft.-lb.)	5	8	15	25	50	90
Drill bit size (in.)	1/4	5/16	3/8	1/2	5/8	3/4
Wrench size ¹ (in.)	3/8	7/16	1/2	9/16	3/4	15/16
Wrench size for coupler nut (in.)			1/2	5/8	3/4	—

1. Applies to acorn- and hex-head configurations only.

Sleeve-All Anchor Product Data — Stainless Steel

Size (in.)	Model No.	Head Style	Bolt Diameter – Threads per inch	Max. Fixture Thickness (in.)	Quantity	
					Box	Carton
3/8 x 1 7/8	SL37178HSS	Hex head	5/16–18	3/8	50	250
3/8 x 3	SL37300HSS			1 1/2	50	200
1/2 x 3	SL50300HSS		3/8–16	3/4	25	100
1/2 x 4	SL50400HSS			1 3/4	25	100

Sleeve-All Anchor (with rod coupler) Product Data — Zinc-Plated Carbon Steel

Size (in.)	Model No.	Accepts Rod Diameter (in.)	Wrench Size (in.)	Quantity	
				Box	Carton
3/8 x 1 7/8	SL37178C	3/8	1/2	50	200
1/2 x 2 1/4	SL50214C	1/2	5/8	25	100
5/8 x 2 1/4	SL62214C	5/8	3/4	20	80

Sleeve-All® Sleeve Anchor

Sleeve-All Anchor Product Data — Zinc-Plated Carbon Steel

Size (in.)	Model No.	Head Style	Bolt Diameter – Threads per inch	Max. Fixture Thickness (in.)	Quantity		
					Box	Carton	
¼ x 1¾	SL25138A	Acorn head	¾-24	¼	100	500	
¼ x 2¼	SL25214A			1½	100	500	
⅝ ₁₆ x 1½	SL31112H	Hex head	¼-20	⅜	100	500	
⅝ ₁₆ x 2½	SL31212H			1⅛	50	250	
⅜ x 1⅞	SL37178H		⅝-18	⅜	50	250	
⅜ x 3	SL37300H			1½	50	200	
⅜ x 4	SL37400H			2¼	50	200	
½ x 2¼	SL50214H		¾-16	½	50	200	
½ x 3	SL50300H			¾	25	100	
½ x 4	SL50400H			1¾	25	100	
½ x 6	SL50600H			3¾	20	80	
⅝ ₈ x 2¼	SL62214H		½-13	½	25	100	
⅝ ₈ x 3	SL62300H			¾	20	80	
⅝ ₈ x 4¼	SL62414H			1½	10	40	
⅝ ₈ x 6	SL62600H			3¼	10	40	
¾ x 2½	SL75212H			⅝-11	½	10	40
¾ x 4¼	SL75414H				⅞	10	40
¾ x 6¼	SL75614H		2⅞		5	20	
¼ x 2	SL25200PF		Phillips flat head	¾-24	⅞	100	500
¼ x 3	SL25300PF				1⅞	50	250
⅝ ₁₆ x 2½	SL31212PF			¼-20	1⅛	50	250
⅝ ₁₆ x 3½	SL31312PF				2⅛	50	250
⅜ x 2¾	SL37234PF	⅝-18		1¼	50	200	
⅜ x 4	SL37400PF			2½	50	200	
⅜ x 5	SL37500PF			3½	50	200	
⅜ x 6	SL37600PF			4½	50	200	
¼ x 2¾	SL25234R			Round head	¾-24	⅞	50

Length Identification Head Marks on Sleeve-All Anchors
(corresponds to length of anchor — inches)

Mark	A	B	C	D	E	F	G	H	I	J	K	L	M	N	O	P	Q	R	S	T	U	V	W	X	Y	Z
From	1½	2	2½	3	3½	4	4½	5	5½	6	6½	7	7½	8	8½	9	9½	10	11	12	13	14	15	16	17	18
Up To But Not Including	2	2½	3	3½	4	4½	5	5½	6	6½	7	7½	8	8½	9	9½	10	11	12	13	14	15	16	17	18	19

Easy-Set Pin-Drive Expansion Anchor

The Easy-Set is a pin-drive expansion anchor for medium- and heavy-duty fastening applications into concrete and grout-filled block. Integrated nut and washer help keep track of parts.

Material: Carbon steel

Coating: Yellow zinc dichromate plated

Installation

 **Caution:** Oversized holes in the base material will make it difficult to set the anchor and will reduce the anchor's load capacity.

1. Drill a hole in the base material using a carbide drill bit the same diameter as the nominal diameter of the anchor to be installed. Drill the hole to the specified embedment depth plus $\frac{1}{4}$ " to allow for pin extension and blow it clean using compressed air. (Overhead installations need not be blown clean.) Alternatively, drill the hole deep enough to accommodate embedment depth and the dust from drilling.
2. Adjust the nut for required embedment. Place the anchor through the fixture and into the hole.
3. Hammer the center pin until the bottom of the head is flush with top of anchor.



Easy-Set
(EZAC)

Installation Sequence

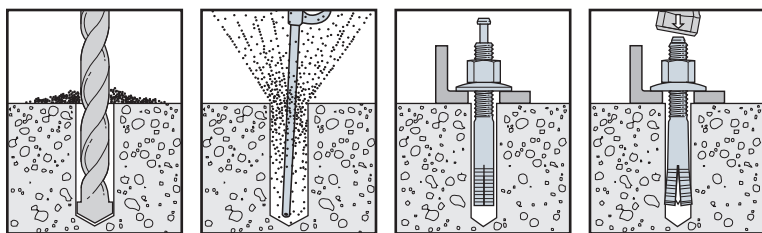

Easy-Set Anchor Installation Data

Easy-Set Diameter (in.)	$\frac{3}{8}$	$\frac{1}{2}$	$\frac{5}{8}$
Drill bit size (in.)	$\frac{3}{8}$	$\frac{1}{2}$	$\frac{5}{8}$
Min. fixture hole size (in.)	$\frac{7}{16}$	$\frac{9}{16}$	$\frac{11}{16}$
Wrench size (in.)	$\frac{9}{16}$	$\frac{3}{4}$	$\frac{15}{16}$

Easy-Set Pin-Drive Expansion Anchor

EZAC Product Data

Size (in.)	Model No.	Thread Length (in.)	Quantity	
			Box	Carton
$\frac{3}{8}$ x 2 $\frac{3}{8}$	EZAC37238	1	50	250
$\frac{3}{8}$ x 3 $\frac{1}{2}$	EZAC37312	1 $\frac{1}{8}$	50	250
$\frac{3}{8}$ x 4 $\frac{3}{4}$	EZAC37434	1 $\frac{1}{2}$	50	200
$\frac{1}{2}$ x 2 $\frac{3}{4}$	EZAC50234	1	25	125
$\frac{1}{2}$ x 3 $\frac{1}{2}$	EZAC50312	1 $\frac{1}{8}$	25	125
$\frac{1}{2}$ x 4 $\frac{3}{4}$	EZAC50434	1 $\frac{1}{2}$	25	100
$\frac{1}{2}$ x 6	EZAC50600	2	25	100
$\frac{5}{8}$ x 4	EZAC62400	1 $\frac{5}{8}$	15	60
$\frac{5}{8}$ x 4 $\frac{3}{4}$	EZAC62434	1 $\frac{5}{8}$	15	60
$\frac{5}{8}$ x 6	EZAC62600	2	15	60

Tie-Wire Wedge Anchor

The tie-wire anchor is a wedge-style expansion anchor for use in normal-weight concrete or in concrete over metal deck. With a tri-segmented, dual-embossed clip, the tie-wire anchor is ideal for the installation of acoustic ceiling grid and is easily set with the claw of a hammer.

Features

- ¼" eyelet for easy threading of wire
- Sets with claw of hammer
- Tri-segmented clip — each segment adjusts independently to hole irregularities
- Dual embossments on each clip segment enable the clip to undercut into the concrete, increasing follow-up expansion
- Wedge-style expansion anchor for use in normal-weight concrete or concrete over metal deck

Material: Carbon steel

Coating: Zinc plated

Installation

1. Drill a hole at least 1½" deep using a ¼"-diameter carbide tipped bit.
2. Drive the anchor into the hole until the bottom of the head is flush with the base material.
3. Set the anchor by prying/pulling the head with the claw end of the hammer.



Tie-Wire
Wedge Anchor

Installation Sequence

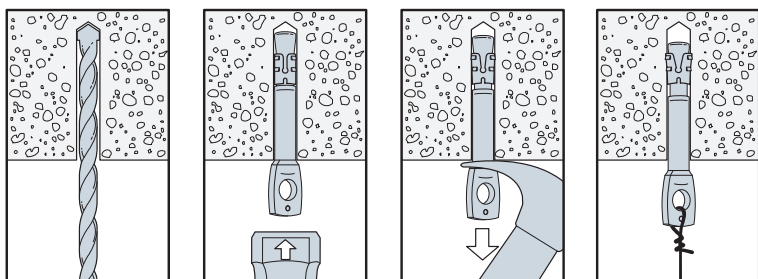

Size (in.)	Model No.	Drill Bit Diameter (in.)	Eyelet Hole Size (in.)	Quantity	
				Box	Carton
¼" x 1½"	TW25112	¼	¼	100	500

Titen® 2 Concrete and Masonry Screw

The Titen 2 concrete and masonry screw is ideal for attaching all types of components to concrete and masonry. The improved thread design undercuts the base material more efficiently, reducing installation torque and making it easier to drive without binding, snapping or stripping, even during installation into hard base material.

Features

- Patented undercutting threads reduce installation torque
- Innovative design increases load capacity
- Suitable for near-edge concrete installations without expansion forces and cracking
- Installs with Standard ANSI drill bits (bit included in larger count boxes)
- Preservative-treated wood applications: suited for use in non-ammonia formulations of CCA, ACQ-C, ACQ-D, CA-B, BX/DOT and zinc borate
- Use in dry interior environments only
- Installs using the TTN2 Installation Kit

Codes: Code listed in accordance with ICC-ES AC193 for concrete application (IAPMO UES ER-449) and ICC-ES AC106 for masonry application (IAPMO UES ER-466); IAPMO UES ER-449 (concrete); IAPMO UES ER-466 (masonry)

Material: Carbon steel

Coating: Zinc plated with baked-on ceramic coating

Installation Sequence

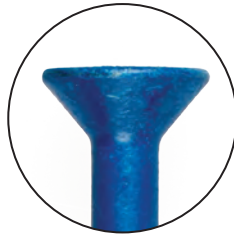
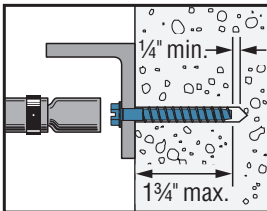
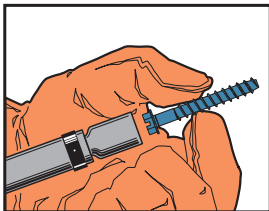
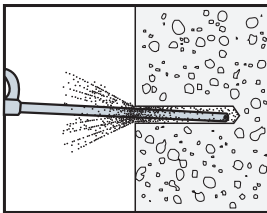
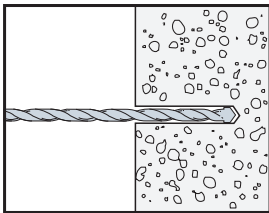

Phillips flat head for flush or countersunk applications

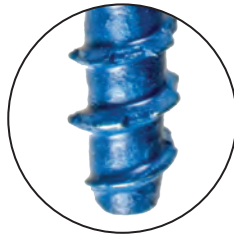

Serrated cutting teeth reduce torque for reliable installations



Titen 2
Hex-Head
Screw

US Patent
9,523,393

Titen® 2 Concrete and Masonry Screw

Blue Titen 2 Product Data

Size (in.)	Head Style	Model No.	Drill Bit Diameter (in.)	Quantity	
				Box	Carton
3/16 x 1 1/4	1/4" hex	TTN2-18114H	5/32	100	1,600
3/16 x 1 3/4		TTN2-18134H		100	500
3/16 x 2 1/4		TTN2-18214H		100	500
3/16 x 2 3/4		TTN2-18234H		100	500
3/16 x 3 1/4		TTN2-18314H		100	400
3/16 x 3 3/4		TTN2-18334H		100	400
3/16 x 4		TTN2-18400H		100	400
1/4 x 1 1/4	5/16" hex	TTN2-25114H	3/16	100	1,600
1/4 x 1 3/4		TTN2-25134H		100	500
1/4 x 2 1/4		TTN2-25214H		100	500
1/4 x 2 3/4		TTN2-25234H		100	500
1/4 x 3 1/4		TTN2-25314H		100	400
1/4 x 3 3/4		TTN2-25334H		100	400
1/4 x 4		TTN2-25400H		100	400
1/4 x 5		TTN2-25500H		100	400
1/4 x 6		TTN2-25600H		100	400
3/16 x 1 1/4	#2 Phillips flat	TTN2-18114PF	5/32	100	500
3/16 x 1 3/4		TTN2-18134PF		100	500
3/16 x 2 1/4		TTN2-18214PF		100	500
3/16 x 2 3/4		TTN2-18234PF		100	400
3/16 x 3 1/4		TTN2-18314PF		100	400
3/16 x 3 3/4		TTN2-18334PF		100	400
3/16 x 4		TTN2-18400PF		100	400
1/4 x 2 1/4	#3 Phillips flat	TTN2-25214PF	3/16	100	400
1/4 x 2 3/4		TTN2-25234PF		100	400
1/4 x 3 1/4		TTN2-25314PF		100	400
1/4 x 3 3/4		TTN2-25334PF		100	400
1/4 x 4		TTN2-25400PF		100	400
1/4 x 5		TTN2-25500PF		100	400
1/4 x 6		TTN2-25600PF		100	400



Mechanical Anchors

Titen® 2 Concrete and Masonry Screw

White Titen 2 Product Data (Phillips Flat-Head)

Size (in.)	Head Style	Model No.	Drill Bit Diameter (in.)	Quantity	
				Box	Carton
3/16 x 1 1/4	#2 Phillips flat	TTN2W18114PF	5/32	100	1,600
3/16 x 1 3/4		TTN2W18134PF		100	500
3/16 x 2 1/4		TTN2W18214PF		100	500
3/16 x 2 3/4		TTN2W18234PF		100	500
3/16 x 3 1/4		TTN2W18314PF		100	400
1/4 x 2 1/4	#3 Phillips flat	TTN2W25214PF	3/16	100	500
1/4 x 2 3/4		TTN2W25234PF		100	500
1/4 x 3 1/4		TTN2W25314PF		100	400
1/4 x 3 3/4		TTN2W25334PF		100	400



Titen® Stainless-Steel Concrete and Masonry Screw

Stainless-steel Titen screws are ideal for attaching various types of components to concrete and masonry, such as fastening electrical boxes or light fixtures. They offer the versatility of our standard Titen screws with enhanced corrosion protection.

Features

- Available in hex and Phillips flat head
- Suitable for concrete, brick, grout-filled CMU and hollow-block applications
- Preservative-treated wood applications: suited for use in non-ammonia formulations of CCA, ACQ-C, ACQ-D, CA-B, BX/DOT and zinc borate
- Acceptable for exterior use
- Titen drill bits included in each box
- Available in lengths from 1 ¼"–4"

Material: Type 410 stainless steel

Coating: Zinc plated with a protective overcoat

Installation

 **Caution:** Industry studies show that hardened fasteners can experience performance problems in wet or corrosive environments. Steps must be taken to prevent inadvertent sustained loads above the listed allowable loads. Overtightening and bending moments can initiate cracks detrimental to the hardened screw's performance. Use the Simpson Strong-Tie Titen installation tool kit as it has a bit that is designed to reduce the potential for overtightening the screw.

 **Caution:** Oversized holes in the base material will reduce or eliminate the mechanical interlock of the threads with the base material and will reduce the anchor's load capacity.

1. Drill a hole in the base material using the appropriate diameter carbide drill bit as specified in the table. Drill the hole to the specified embedment depth plus ½" to allow the thread tapping dust to settle and blow it clean using compressed air. Overhead installations need not be blown clean. Alternatively, drill the hole deep enough to accommodate embedment depth and dust from drilling and tapping.
2. Position fixture, insert screw and tighten using drill and Titen screw installation tool fitted with a hex socket or phillips bit.

Use caution not to damage coating during installation. The 410 stainless-steel Titen with top coat provides "medium" corrosion protection. Recommendations are based on testing and experience at time of publication and may change. Simpson Strong-Tie cannot provide estimates on service life of screws.



Titen
Stainless-Steel
Phillips Flat-
Head Screw
(PFSS)

Titen
Stainless-Steel
Hex-Head
Screw
(HSS)

Titen® Stainless-Steel Concrete and Masonry Screw

Installation Sequence

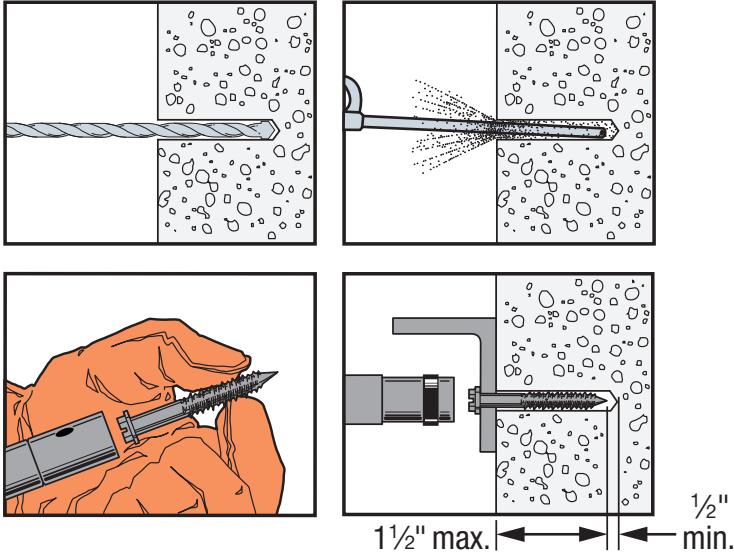

Stainless-Steel Titen Product Data

Size (in.)	Head Style	Model No.	Drill Bit Diameter (in.)	Quantity	
				Box	Carton
1/4 x 1 1/4	Hex head	TTN25114HSS	3/16	100	1600
1/4 x 1 3/4		TTN25134HSS		100	500
1/4 x 2 1/4		TTN25214HSS		100	500
1/4 x 2 3/4		TTN25234HSS		100	500
1/4 x 3 1/4		TTN25314HSS		100	400
1/4 x 3 3/4		TTN25334HSS		100	400
1/4 x 4		TTN25400HSS		100	400
1/4 x 1 1/4	Phillips flat head	TTN25114PFSS	3/16	100	1600
1/4 x 1 3/4		TTN25134PFSS		100	500
1/4 x 2 1/4		TTN25214PFSS		100	500
1/4 x 2 3/4		TTN25234PFSS		100	500
1/4 x 3 1/4		TTN25314PFSS		100	400
1/4 x 3 3/4		TTN25334PFSS		100	400
1/4 x 4		TTN25400PFSS		100	400

One drill bit is included in each box.

Titen® Screw — Installation Accessories

Titen Screw — Installation Tool

The Simpson Strong-Tie® Titen screw installation kit makes installation of Titen screws quick and easy. Accessories are compatible with a standard three-jaw style chuck, and the sockets have been designed to prevent over-torquing, which can lead to fastener failure. Comes packaged in a rugged plastic box ideal for storage of the installation kit and Titen screws.

Eight-piece kit includes:

- Drill bit holder
- 5¾" sleeve
- ¼" and ⅝" hex sockets
- Phillips bit socket
- #2 and #3 Phillips bits
- Allen wrench

Titen Installation Tool

Model No.	Quantity	
	Box	Carton
TTN2INSTALLKIT	1	4



Titen 2 Screw Installation Kit
(Model TTN2INSTALLKIT)



Special hex adapter (included with the Titen Screw Installation Kit) allows the Titen Installation Tool to slide over the bit and lock in, ready to drive screws.

Titen® Screw – Installation Accessories

Titen Screw – Drill Bits

The same bits that come included with boxes of Titen screws are also available separately. They work with the Titen Installation Tool as well as drills with a standard three-jaw style chuck.



Titen Screw Drill Bit

Titen Drill Bits

Size (in.)	Model No.	Use With		Quantity	
		Screw	Length	Box	Carton
5/32 x 3 1/2	MDB15312	3/16" diameter	To 1 3/4	12	48
5/32 x 4 1/2	MDB15412		To 3 1/4		
5/32 x 5 1/2	MDB15512		To 4		
3/16 x 3 1/2	MDB18312	1/4" diameter	To 1 3/4	12	48
3/16 x 4 1/2	MDB18412		To 3 1/4		
3/16 x 5 1/2	MDB18512		To 4		

Titen Screw – SDS-plus® Drill Bit/Driver

This SDS-plus shank bit works with the Titen Installation Tool to allow pre-drilling and installation of Titen screws using a rotohammer. Rotohammer must be in rotation-only mode before driving screws.



Titen Screw SDS-plus Drill Bit/Driver

Titen Drill Bit/Driver Product Data

Size (in.)	Model No.	For Screw Diameter (in.)	Drilling Depth (in.)	Overall Length (in.)
5/32 x 6	MDPL01506H	3/16	3 1/8	6
5/32 x 7	MDPL01507H		4 1/8	7
3/16 x 5	MDPL01805H	1/4	2 3/8	5
3/16 x 6	MDPL01806H		3 1/8	6
3/16 x 7	MDPL01807H		4 1/8	7

Titen drivers are sold individually.

Titen HD® Threaded Rod Hanger

The Titen HD threaded rod hanger is a high-strength screw anchor designed to suspend threaded rod from concrete slabs, beams or concrete over metal in order to hang pipes, cable trays and other HVAC equipment. The anchor offers low installation torque with no secondary setting, and has been tested to offer industry-leading performance in cracked and uncracked concrete — even in seismic loading conditions.

Features

- Thread design undercuts to efficiently transfer the load to the base material
- Serrated cutting teeth and patented thread design enable quick and easy installation
- Specialized heat-treating process creates tip hardness to facilitate cutting while the anchor body remains ductile
- No special drill bit required — designed to install using standard-sized ANSI tolerance drill bits
- Installs with standard-sized sockets

Codes: Code listed for cracked and uncracked concrete applications under the 2015, 2012 and 2009 IBC/IRC, per ICC-ES ESR-2713; ICC-ES ESR-2713 (THD37212RH and THD50234RH); City of L.A. RR25741; Florida FL-15730.6; Factory Mutual 3031136 (THD50234RH and THD37218RH) and 3035761 (THD37212RH); UL/FM listed

Material: Carbon steel

Coating: Zinc plated

Installation

 **Caution:** Oversized holes in the base material will reduce or eliminate the mechanical interlock of the threads with base material and will reduce the anchor's load capacity.

 **Caution:** Use a Titen HD rod hanger one time only. Installing the anchor multiple times may result in excessive thread wear and reduce load capacity.

1. Drill a hole using the specified diameter carbide bit into the base material to the specified embedment depth plus minimum hole depth overdrill (see the product data table on the next page).
2. Blow the hole clean of dust and debris using compressed air.
3. Install the anchor into the hole.
4. Fully insert threaded rod.



THD50234RH
($\frac{3}{8}$ "-dia. shank)



THDB25158RH
($\frac{1}{4}$ "-dia. shank)



THDB37158RH
($\frac{1}{4}$ "-dia. shank)

US Patent 6,623,228



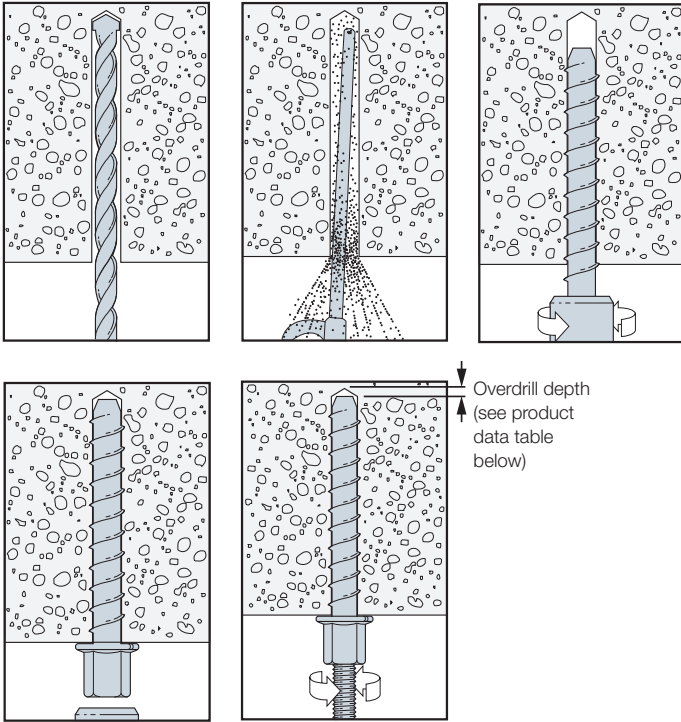

Titen HD® Threaded Rod Hanger

Mechanical Anchors

Installation Sequence



Titen HD Threaded Rod Hanger Product Data

Size (in.)	Model No.	Accepts Rod Dia. (in.)	Drill Bit Dia. (in.)	Wrench Size (in.)	Min. Embed. (in.)	Hole Depth Overdrill (in.)	Quantity	
							Box	Carton
 ¼ x 1½	THDB25158RH	¼	¼	¾	1½	⅞	100	500
  ¾ x 1½	THDB37158RH	¾	¼	½	1½	⅞	50	200
  ½ x 2¾	THD50234RH	½	¾	1⅞	2½	¼	50	100

Steel Rod Hanger Threaded Rod Anchor System

The Simpson Strong-Tie® steel rod hanger is a one-piece fastening system for suspending ¼" and ¾" threaded rod. Vertical rod hangers are designed to suspend threaded rod in overhead applications from steel joists and beams. Horizontal rod hangers are available for applications requiring installation into the side of joists, columns and overhead members. Both rod hangers provide attachment points for use in pipe hanging, fire protection, electrical conduit and cable-tray applications. Recommended for use in dry, interior, non-corrosive environments only.

Features

- Self-drilling, no predrilling required, easily installed with a drill or screw gun
- Custom-matched nut driver sets anchor to optimal depth
- UL / FM listed

Nut Driver

Custom-matched nut driver sets the rod hangers to optimal depth every time.

Model No.	Description	Quantity	
		Box	Carton
RND62	Nut driver	10	60



RSH
Horizontal Steel
Rod Hangers



RSV
Vertical Steel
Rod Hangers



RND62

Steel Rod Hanger Threaded Rod Anchor System

Steel Rod Hangers

Rod Diameter (in.)	Size	Model No.	Drill Point	Application	Steel Thickness Range	Quantity	
						Box	Carton
1/4	1/4" x 1" with nut	RSH25100N	#3	Horizontal	20 ga. – 12 ga.	25	250
1/4	#12–20 x 1 1/2"	RSH25112-5	#5		20 ga. – 1/4"		
3/8	1/4" x 1" with nut	RSH37100N	#3		20 ga. – 12 ga.		
3/8	#12–20 x 1 1/2"	RSH37112N-5	#5		20 ga. – 1/4"		
1/4	1/4" x 1"	RSV25100	#3	Vertical	20 ga. – 12 ga.	25	250
3/8	1/4" x 1" with nut	RSV37100N	#3		20 ga. – 12 ga.		
3/8	1/4" x 1 1/2"	RSV37112	#3		20 ga. – 14 ga.		
3/8	1/4" x 1 1/2" with nut	RSV37112N	#3		20 ga. – 14 ga.		
3/8	#12–20 x 1 1/2"	RSV37112N-5	#5		20 ga. – 1/4"		
3/8	1/4" x 2"	RSV37200	#3		20 ga. – 14 ga.		

Vertical Installation

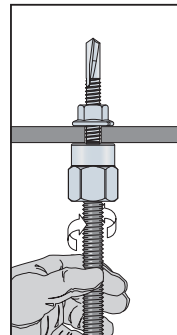
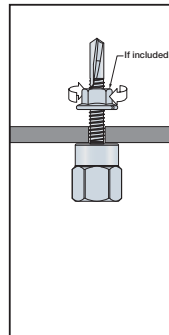
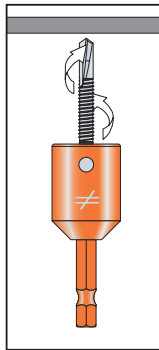
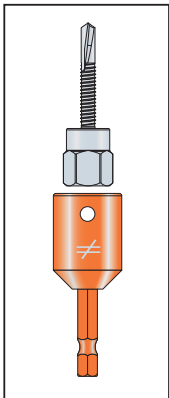

Steel Rod Hanger Threaded Rod Anchor System

Horizontal Installation

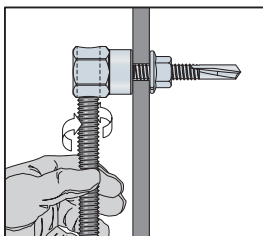
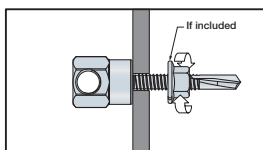
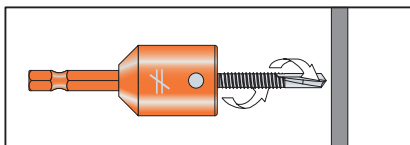
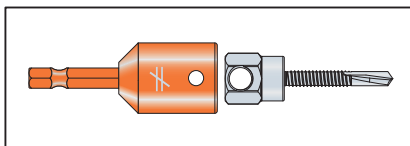

Wood Rod Hanger Threaded Rod Anchor System

The wood rod hanger from Simpson Strong-Tie is a one-piece fastening system for suspending $\frac{1}{4}$ " or $\frac{3}{8}$ " threaded rod. Vertical rod hangers are designed to suspend threaded rod in overhead applications from wood members. Horizontal rod hangers are available for applications requiring installation into the side of joists, columns and overhead members. Both rod hangers provide attachment points for use in pipe hanging, fire protection, electrical conduit and cable-tray applications. Recommended for use in dry, interior, non-corrosive environments only.

Features

- No predrilling required
- Easily installed with an impact driver or screw gun
- Type-17 point provides for fast starts
- UL/FM Listed

Material: Carbon steel

Coating: Zinc plated



RWV
Vertical Wood
Rod Hanger



RWH
Horizontal Wood
Rod Hanger



Type-17
point for
use in wood

Wood Rod Hangers

Rod Diameter (in.)	Size (in.)	Model No.	Application	Point Style	Quantity	
					Box	Carton
$\frac{1}{4}$	$\frac{1}{4} \times 2$	RWV25200	Vertical	Type 17	25	250
$\frac{3}{8}$	$\frac{1}{4} \times 1$	RWV37100				
$\frac{3}{8}$	$\frac{1}{4} \times 2$	RWV37200				
$\frac{3}{8}$	$\frac{5}{16} \times 2\frac{1}{2}$	RWV37212				
$\frac{1}{4}$	$\frac{1}{4} \times 1$	RWH25100	Horizontal	Type 17	25	250
$\frac{3}{8}$	$\frac{1}{4} \times 2$	RWH37200				
$\frac{3}{8}$	$\frac{5}{16} \times 2\frac{1}{2}$	RWH37212				

Wood Rod Hanger Threaded Rod Anchor System

Installation Sequence

1. Attach RND62 nut driver to a drill.
2. Insert rod hanger into the RND62 nut driver.
3. Using rotation-only mode, drive rod hanger until it contacts the surface. Do not over-tighten. RND62 nut driver will disengage the rod hanger at the appropriate depth to prevent over-driving.
4. Insert threaded rod. Minimum thread engagement should be equal to the nominal diameter of the threaded insert.

Vertical Wood Rod Hanger

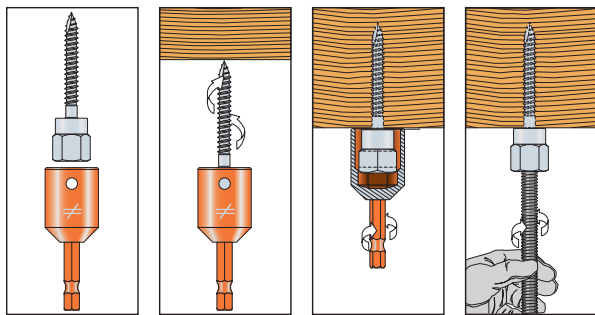

Horizontal Wood Rod Hanger

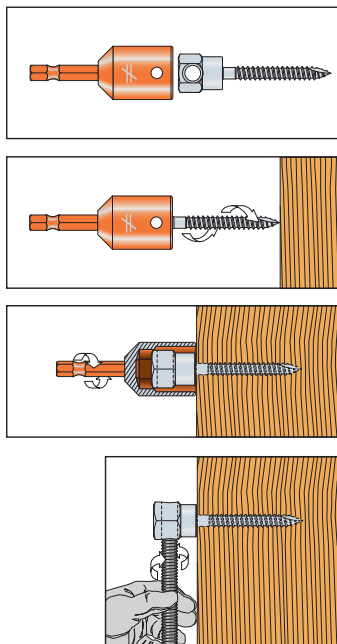

Drop-In Internally Threaded Anchor (DIAB)

Expansion shell anchors for use in solid base materials

Drop-In Anchors (DIAB) provide easier installation into base materials. These displacement-controlled expansion anchors are easily set by driving the plug toward the bottom of the anchor using either the hand- or power-setting tools. DIAB anchors feature a positive-set marking indicator at the top of the anchor — helping you see more clearly when proper installation has taken place.

Use a Simpson Strong-Tie fixed-depth stop bit to take the guesswork out of drilling to the correct depth. The fluted design of the tip draws debris away from the hole during drilling, allowing for a cleaner installation.

Features

- Positive-set marking system indicates when anchor is properly set
- Lipped drop-in version available for flush installation
- Hand- and power-setting tools available for fast, easy and economical installation
- Fixed-depth stop bit helps you drill to the correct depth every time
- Available in coil-thread version for ½" and ¾" coil-thread rod

Codes: Factory Mutual 3053987 (¾" – ¾"); Underwriters Laboratories File Ex3605. Meets requirements of Federal Specifications A-A-55614, Type 1

Material: Carbon steel

Coating: Zinc plated



Drop-In



Lipped
Drop-In



Coil-Thread
Drop-In

Drop-In Internally Threaded Anchor (DIAB)



Anchor being set with hand setting tool.



Anchor being set with SDS setting tool.



Positive set indicator.

Drop-In Internally Threaded Anchor (DIAB)

Drop-In Anchor

Rod Size (in.)	Model No.	Drill Bit Dia. (in.)	Bolt Threads (per in.)	Body Length (in.)	Thread Length (in.)	Quantity	
						Box	Carton
¼	DIAB25	¾	20	1	¾	100	500
¾	DIAB37	½	16	1⅞	⅝	50	250
½	DIAB50	⅝	13	2	¾	50	200
⅝	DIAB62	⅞	11	2½	1	25	100
¾	DIAB75	1	10	3⅞	1¼	20	80



Drop-In

Lipped Drop-In Anchor

Rod Size (in.)	Model No.	Drill Bit Dia. (in.)	Bolt Threads (per in.)	Body Length (in.)	Thread Length (in.)	Quantity	
						Box	Carton
¼	DIABL25	¾	20	1	¾	100	500
¾	DIABL37	½	16	1⅞	⅝	50	250
½	DIABL50	⅝	13	2	¾	50	200



Lipped Drop-In

Coil-Thread Drop-In Anchor

Rod Size (in.)	Model No.	Drill Bit Dia. (in.)	Bolt Threads (per in.)	Body Length (in.)	Thread Length (in.)	Quantity	
						Box	Carton
½	DIAB50C ¹	⅝	6	2	¾	50	200
¾	DIAB75C ¹	1	4½	3⅞	1¼	20	80

1. DIAB50C and DIAB75C accept ½" and ¾" coil-thread rod, respectively.



Coil-Thread Drop-In

Drop-In Internally Threaded Anchor (DIAB)

DIABST Drop-In Anchor Hand-Setting Tool

Hand-setting tool designed for use with the Simpson Strong-Tie® Drop-In anchor (DIAB), ensuring fast, easy and economical installation.



Hand Setting Tool

Model No.	Description	Box Quantity	Carton Qty.
DIABST25	Setting tool for use with Drop-In models DIAB25, DIABL25	10	50
DIABST37	Setting tool for use with Drop-In models DIAB37, DIABL37	10	50
DIABST50	Setting tool for use with Drop-In models DIAB50, DIABL50, DIAB50C	10	50
DIABST62	Setting tool for use with Drop-In model DIAB62	5	25
DIABST75	Setting tool for use with Drop-In models DIAB75, DIAB75C	5	20

1. Setting tools sold separately. Tools may be ordered by the piece.

DIABST (SDS-plus®) Drop-In Anchor Power-Setting Tool

Power-setting tool featuring an SDS-plus shank, designed for use with the Simpson Strong-Tie® Drop-In anchor (DIAB), ensuring fast, easy and economical installation.



Power Setting Tool

Model No.	Description	Box Quantity	Carton Qty.
DIABST25-SDS	Power-setting tool for use with Drop-In models DIAB25, DIABL25	10	50
DIABST37-SDS	Power-setting tool for use with Drop-In models DIAB37, DIABL37	10	50
DIABST50-SDS	Power-setting tool for use with Drop-In models DIAB50, DIABL50, DIAB50C	10	50

1. Setting tools sold separately. Tools may be ordered by the piece.

Drop-In Internally Threaded Anchor (DIAB)

DIAB Manual Installation

⚠ Caution: Oversized holes will reduce the anchors load capacity.

1. Drill a hole in the base material using the appropriate diameter carbide drill bit or fixed-depth bit as specified in the table. Drill the hole to the specified embedment. For fixed-depth bits drill the hole until the shoulder of the bit contacts the surface of the base material. Then blow the hole clean of dust and debris using compressed air. Overhead installations need not be blown clean.
2. Insert the anchor into the hole. Tap with hammer until flush against the surface.
3. Using the designated Drop-In setting tool, drive expander plug towards the bottom of the anchor until the shoulder of the setting tool makes contact with the top of the anchor. When properly set four indentations will be visible on the top of the anchor indicating full expansion.
4. Insert bolt or threaded rod. Minimum thread engagement should be equal to the nominal diameter of the threaded insert.

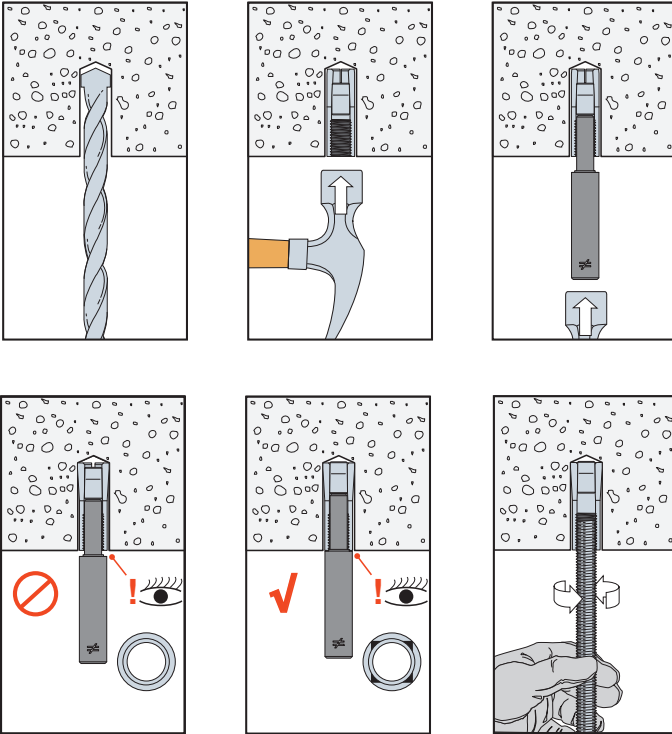

Drop-In Internally Threaded Anchor (DIAB)

DIAB SDS Installation



Caution: Oversized holes will reduce the anchors load capacity.

1. Drill a hole in the base material using the appropriate diameter carbide drill bit or fixed-depth drill bit as specified in the table. Drill the hole to the specified embedment. For fixed-depth bits drill the hole until the shoulder of the bit contacts the surface of the base material. Then blow the hole clean of dust and debris using compressed air. Overhead installations need not be blown clean.
2. Insert the anchor into the hole. Tap with hammer until flush against the surface.
3. Attach SDS Drop-In setting tool to a drill. Drive expander plug towards the bottom of the anchor using only hammer mode until the shoulder of the setting tool makes contact with the top of the anchor. When properly set four indentations will be visible on the top of the anchor indicating full expansion.
4. Insert bolt or threaded rod. Minimum thread engagement should be equal to the nominal diameter of the threaded insert.

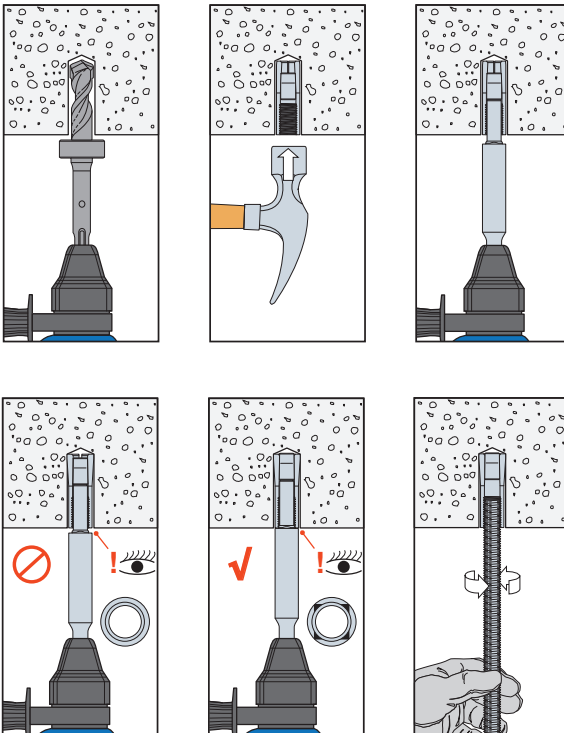

Drop-In Short / Drop-In Stainless Steel Internally Threaded Anchor (DIA)

Drop-in anchors are internally threaded drop-in expansion anchors for use in flush-mount applications in solid base materials. Available in stainless steel (DIA) or short (DIAS) version. Minimum thread engagement should be equal to the nominal diameter of the threaded insert.

Features

- Lipped edge (DIAS) eliminates need for precisely drilled hole depth
- Hand- and power-setting tools available for fast, easy and economical installation
- Fixed-depth stop bit helps you drill to the correct depth every time
- Short length (DIAS) enables shallow embedment to help avoid drilling into rebar or pre-stressed/post-tensioned cables
- Short drop-in anchors include a setting tool compatible with the anchor to ensure consistent installation

Codes: DOT; Factory Mutual 3017082; Underwriters Laboratories File Ex3605. Meets requirements of Federal Specifications A-A-55614, Type I.

Material: Stainless steel and carbon steel

Coating: Carbon steel; zinc plated

Installation

Caution: The load tables list values based upon results from the most recent testing and may not reflect those in current code reports. Where code jurisdictions apply, consult the current reports for applicable load values.

1. Drill a hole in the base material using the appropriate diameter carbide drill bit as specified in the table. Drill the hole to the specified embedment depth plus $\frac{1}{8}$ " for flush mounting. Blow the hole clean using compressed air. Overhead installations need not be blown clean.
2. Insert designated anchor into hole. Tap with hammer until flush against surface.
3. Using the designated drop-in setting tool, drive expander plug toward the bottom of the anchor until shoulder of setting tool makes contact with the top of the anchor.
4. Minimum thread engagement should be equal to the nominal diameter of the threaded insert.

Caution: Oversized holes will make it difficult to set the anchor and will reduce the anchor's load capacity.



**Drop-In
Stainless Steel**



Short Drop-In

Drop-In Short / Drop-In Stainless Steel Internally Threaded Anchor (DIA)

Installation Sequence

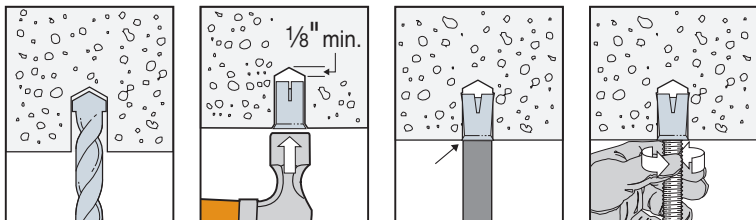

Drop-In Anchor Product Data — Stainless Steel

Rod Size (in.)	Type 303/304 Stainless Model No.	Type 316 Stainless Model No.	Drill Bit Diameter (in.)	Bolt Threads (per in.)	Body Length (in.)	Thread Length (in.)	Quantity	
							Box	Carton
1/4	DIA25SS	DIA256SS	3/8	20	1	3/8	100	500
3/8	DIA37SS	DIA376SS	1/2	16	1 9/16	5/8	50	250
1/2	DIA50SS	DIA506SS	5/8	13	2	3/4	50	200
5/8	DIA62SS	—	7/8	11	2 1/2	1	25	100
3/4	DIA75SS	—	1	10	3 1/8	1 1/4	20	80

Short Drop-In Anchor Product Data

Rod Size (in.)	Model No.	Drill Bit Diameter (in.)	Bolt Threads (per in.)	Body Length (in.)	Thread Length (in.)	Quantity	
						Box	Carton
3/8	DIA37S ¹	1/2	16	3/4	1/4	100	500
1/2	DIA50S ¹	5/8	13	1	5/16	50	200

1. A dedicated setting tool is included with each box of DIA37S and DIA50S.

Material Specifications

Anchor Component	Component Material		
	Zinc Plated Carbon Steel	Type 303/304 Stainless Steel	Type 316 Stainless Steel
Anchor body	Meets minimum 70,000 psi tensile	AISI 303. Meets chemical requirements of ASTM A582	Type 316
Expander plug	Meets minimum 50,000 psi tensile	AISI 303	Type 316
Thread	UNC/Coil-thread	UNC	UNC

Hollow Drop-In Internally Threaded Anchor

The Simpson Strong-Tie® Hollow Drop-In Anchor (HDIA) is an internally threaded, flush-mount expansion anchor for use in hollow materials such as CMU and hollow-core plank, as well as in solid base materials such as brick, normal-weight and lightweight concrete.

Features

- Suitable for suspending conduit, cable trays, pipe supports, fire sprinklers and suspended lighting into concrete
- Expansion design allows HDIA to anchor into CMU, hollow-core plank, brick, normal-weight concrete and lightweight concrete
- Internally threaded anchor allows for easy bolt removal

Codes: Factory Mutual 3053987 (3/8"–1/2" diameter); Underwriters Laboratories File Ex3605 (3/8"–1/2" diameter)

Material: Die-cast Zamac 3 alloy shell with carbon-steel cone or 304 stainless-steel cone



Hollow Drop-In Anchor

Size (in.)	Model No.	Drill Bit Diameter (in.)	Threads (per in.)	Overall Anchor Length (in.)	Quantity	
					Package Qty.	Carton Qty.
1/4	HDIA25	3/8	20	3/4	100	1,600
1/4	HDIA25SS	3/8	20	3/4	100	1,600
5/16	HDIA31	5/8	18	1 1/4	50	200
3/8	HDIA37	5/8	16	1 1/4	50	200
3/8	HDIA37SS	5/8	16	1 1/4	50	200
1/2	HDIA50	3/4	13	1 3/4	50	200
5/8	HDIA62	1	11	2	25	125

Hollow Drop-In Internally Threaded Anchor

HDIASTH Setting Tool for Hollow Materials

Setting tool designed to set the Hollow Drop-In internally threaded anchor in hollow materials such as CMU and hollow-core plank.

Model No.	Description	Size (in.)	Carton Qty.
HDIASTH25	Setting tool for use with Hollow Drop-In models HDIA25, HDIA25SS	¼	25
HDIASTH31	Setting tool for use with Hollow Drop-In model HDIA31	⅝	25
HDIASTH37	Setting tool for use with Hollow Drop-In models HDIA37, HDIA37SS	¾	25
HDIASTH50	Setting tool for use with Hollow Drop-In model HDIA50	½	25
HDIASTH62	Setting tool for use with Hollow Drop-In model HDIA62	⅝	10

1. Tools sold separately. Tools may be ordered by the piece.

HDIASTS Setting Tool for Solid Materials

Setting tool designed to set the Hollow Drop-In internally threaded anchor in solid materials such as brick, normal-weight and lightweight concrete.

Model No.	Description	Size (in.)	Box Qty.	Carton Qty.
HDIASTS25	Setting tool for use with Hollow Drop-In models HDIA25, HDIA25SS	¼	25	125
HDIASTS31-37	Setting tool for use with Hollow Drop-In models HDIA31, HDIA37, HDIA37SS	⅝ – ¾	10	50
HDIASTS50	Setting tool for use with Hollow Drop-In model HDIA50	½	10	50
HDIASTS62	Setting tool for use with Hollow Drop-In model HDIA62	⅝	5	20

1. Tools sold separately. Tools may be ordered by the piece.



Hollow Drop-In Internally Threaded Anchor

Installation Instructions:

Solid Base (using solid setting tool)

- Drill a hole in the base material using the appropriate diameter carbide drill bit as specified in the table. Drill the hole to the specified embedment depth.
- Blow the hole clean using compressed air. Overhead installations need not be blown clean.
- Insert the HDIA into hole. Tap with hammer until flush against surface.
- Using the designated setting tool, drive the anchor to the bottom of the drilled hole. After the anchor reaches the bottom of the drilled hole, perform an additional three hammer blows against the setting tool to drive the anchor body over the cone.
- Position fixture; insert fastener and tighten.

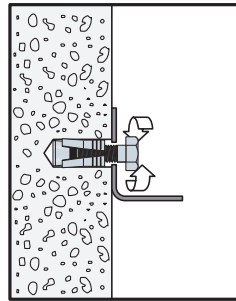
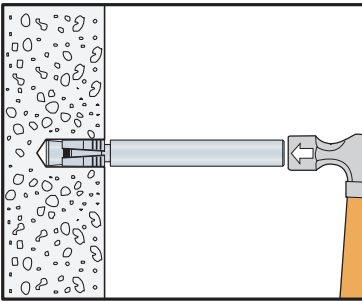
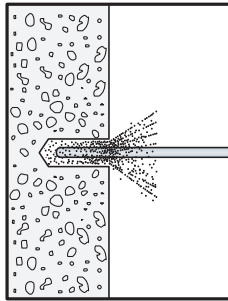
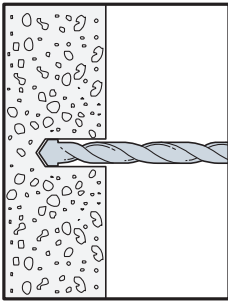

Hollow Drop-In Internally Threaded Anchor

Installation Instructions:

Hollow Base (using hollow setting tool)

- Drill a hole in the base material using the appropriate diameter carbide drill bit as specified in the table.
- Thread the HDIA onto the designated setting tool for hollow base materials.
- Insert the HDIA into the hole. Tap the setting tool until the face of the tool contacts the surface.
- Rotate the setting tool a minimum of two turns to set the anchor.
- Remove the setting tool.
- Position fixture; insert fastener and tighten.

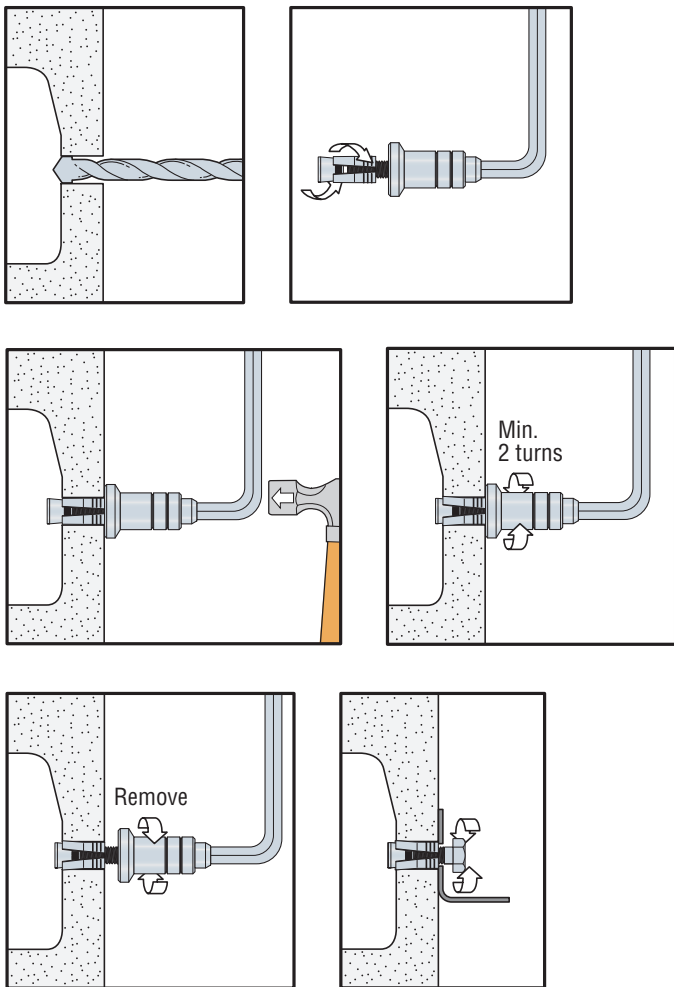

Zinc Nailon™ Pin Drive Anchors

Zinc Nailon anchors are low-cost, easy-to-install anchors for applications under static loads.

Features



- Available with carbon and stainless-steel pins
- Pin and head configuration designed to make anchor tamper-resistant

Code: Meets Federal Specification A-A-1925A, Type 1

Materials

- Body — Die-cast Zamac 3 alloy
- Pin — Carbon steel; Type 304 stainless steel

Installation

-  **Caution:** Not for use in overhead applications.
-  **Caution:** Nailon anchors are not recommended for eccentric tension (prying) loads — capacity will be greatly reduced in such applications

1. Drill a hole in base material using a carbide drill bit the same diameter as the nominal diameter of the anchor to be installed. Drill the hole to specified embedment depth, plus ¼" for pin extension, and blow hole clean using compressed air. Alternatively, drill the hole deep enough to accommodate embedment depth and dust from drilling.
2. Position fixture and insert Nailon anchor.
3. Tap with hammer until flush with fixture, then drive pin until flush with top of head.



Zinc Nailon Anchor
(mushroom)

Installation Sequence

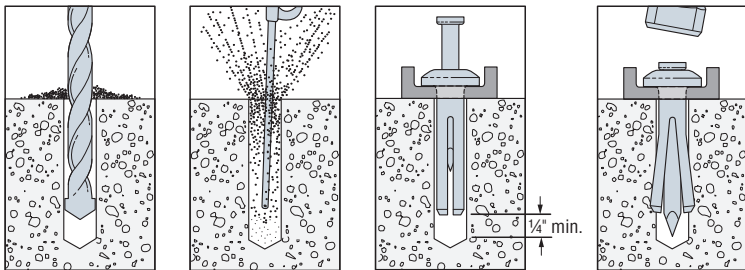

Zinc Nailon™ Pin Drive Anchors

Zinc Nailon™ Product Data

Size (in.)	Carbon-Steel Pin Model No.	Stainless-Steel Pin Model No.	Quantity		
			Box	Carton	Bulk
3/16 x 7/8	ZN18078	—	100	1,600	3,000
1/4 x 3/4	ZN25034	ZN25034SS	100	500	2,000
1/4 x 1	ZN25100	ZN25100SS	100	500	1,500
1/4 x 1 1/4	ZN25114	ZN25114SS	100	500	1,500
1/4 x 1 1/2	ZN25112	ZN25112SS	100	500	1,000
1/4 x 2	ZN25200	ZN25200SS	100	400	1,000
1/4 x 2 1/2	ZN25212	ZN25212SS	100	400	1,000
1/4 x 3	ZN25300	ZN25300SS	100	400	1,000

Crimp Drive® Anchor

The crimp anchor is an easy-to-install expansion anchor for use in concrete and grout-filled block. The pre-formed curvature along the shaft creates an expansion mechanism that secures the anchor in place and eliminates the need for a secondary tightening procedure. This speeds up anchor installation and reduces the overall cost.

Five crimp anchor head styles are available to handle different applications that include fastening wood or light-gauge steel, attaching concrete formwork, hanging overhead support for sprinkler pipes or suspended ceiling panels.

Codes: Factory Mutual 3031 136 for the $\frac{3}{8}$ " Rod Coupler.

Material: Carbon steel, stainless steel

Coating: Zinc plated and mechanically galvanized

Head Styles: Mushroom, rod coupler, countersunk, tie-wire and duplex

Installation

Warning: Industry studies show that hardened fasteners can experience performance problems in wet or corrosive environments. Accordingly, with the exception of the duplex anchor, use these products in dry, interior and non-corrosive environments only.

1. Drill a hole using the specified diameter carbide bit into the base material to a depth of at least $\frac{1}{2}$ " deeper than the required embedment.
2. Blow the hole clean of dust and debris using compressed air. Overhead application need not be blown clean. Where a fixture is used, drive the anchor through the fixture into the hole until the head sits flush against the fixture.
3. Be sure the anchor is driven to the required embedment depth. The rod coupler and tie-wire models should be driven in until the head is seated against the surface of the base material.



Mushroom
Head



Rod
Coupler



Countersunk
Head



Tie-Wire



Duplex

Crimp Drive® Anchor

Installation Sequence

Rod Coupler

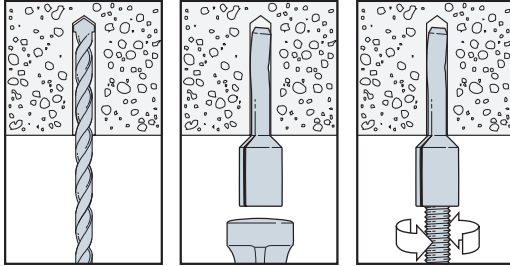

Tie-Wire

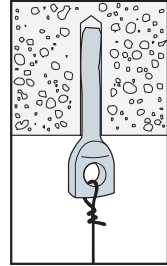

Mushroom Head

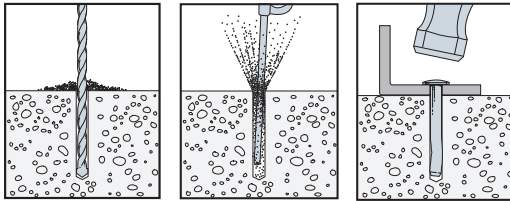

Duplex

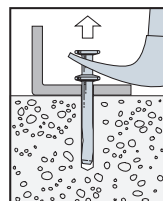

Duplex-head anchor may be removed with a claw hammer.

Countersunk Head Installation Sequence

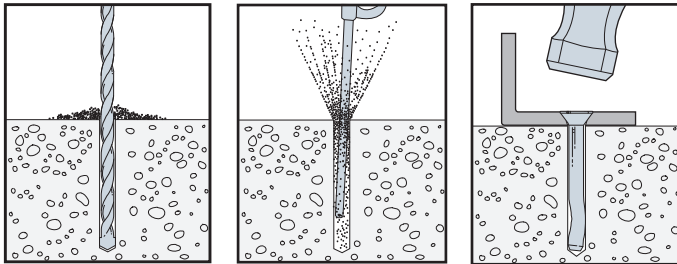

Length Identification Head Marks on Mushroom, Countersunk and Duplex-Head Crimp Drive Anchors (corresponds to length of anchor — inches)

Mark	□	A	B	C	D	E	F
From	1	1½	2	2½	3	3½	4
Up To But Not Including	1½	2	2½	3	3½	4	4½

Crimp Drive® Anchor

Crimp Drive Anchor Product Data

Size (in.)	Model No.	Head Style/Finish	Drill Bit Dia. (in.)	Min. Fixture Hole Size (in.)	Min. Embed. (in.)	Quantity		
						Pkg. Qty.	Carton Qty.	
3/16 x 1 1/4	CD18114M	Mushroom head / zinc plated	3/16	1/4	7/8	100	1,600	
3/16 x 2	CD18200M				1 1/4	100	500	
3/16 x 2 1/2	CD18212M				1 1/4	100	500	
3/16 x 3	CD18300M				1 1/4	100	500	
3/16 x 3 1/2	CD18312M				1 1/4	100	500	
3/16 x 4	CD18400M				1 1/4	100	500	
1/4 x 1	CD25100M		1/4	5/16	7/8	100	1,600	
1/4 x 1 1/4	CD25114M				7/8	100	1,600	
1/4 x 1 1/2	CD25112M				1 1/4	100	1,600	
1/4 x 2	CD25200M				1 1/4	100	500	
1/4 x 2 1/2	CD25212M				1 1/4	100	500	
1/4 x 3	CD25300M				1 1/4	100	500	
1/4 x 3 1/2	CD25312M				1 1/4	100	500	
1/4 x 4	CD25400M				1 1/4	100	500	
3/8 x 2	CD37200M	3/8			7/16	1 3/4	25	125
3/8 x 3	CD37300M					1 3/4	25	125
1/4 x 3	CD25300MG	Mushroom head / mechanically galvanized	1/4	5/16	1 1/4	100	500	
1/4" rod coupler	CD25114RC	Rod coupler / zinc plated	3/16	N/A	1 1/4	100	500	
3/8" rod coupler	CD37112RC		1/4	N/A	1 1/2	50	250	
3/16 x 2 1/2	CD18212C	Countersunk head / zinc plated	3/16	1/4	1 1/4	100	500	
3/16 x 3	CD18300C				1 1/4	100	500	
3/16 x 4	CD18400C				1 1/4	100	500	
1/4 x 1 1/2	CD25112C		1/4	5/16	1 1/4	100	500	
1/4 x 2	CD25200C				1 1/4	100	500	
1/4 x 2 1/2	CD25212C				1 1/4	100	500	
1/4 x 3	CD25300C				1 1/4	100	500	
1/4 x 3 1/2	CD25312C				1 1/4	100	400	
1/4 x 4	CD25400C				1 1/4	100	400	
1/4 x 3	CD25300CMG				Countersunk head / mechanically galvanized ¹	1/4	5/16	1 1/4
1/4 x 4	CD25400CMG	1 1/4	100	400				
1/4" Tie Wire	CD25118T	Tie Wire / zinc plated	1/4	N/A	1 1/8	100	500	
1/4" duplex	CD25234D	Duplex head / zinc plated	1/4	5/16	1 1/4	100	500	

1. Mechanical galvanizing meets ASTM B695, Class 55, Type 1. Intended for some pressure-treated wood sill plate applications. Not for use in other corrosive or outdoor environments. See strongtie.com for details.

CSD/DSD Split-Drive Anchors

The Split-Drive anchor is a one-piece expansion anchor that can be installed in concrete, grout-filled block and stone. As the anchor is driven in, the split-type expansion mechanism on the working end compresses and exerts force against the walls of the hole.

Features

- Available in countersunk (CSD) and duplex-head (DSD) styles
- DSD anchor can be removed with a claw hammer for temporary applications

Material: Carbon steel

Coating: Zinc plated; mechanically galvanized

Installation

Warning (CSD only): Industry studies show that hardened fasteners can experience performance problems in wet or corrosive environments. Accordingly, use these products in dry, interior and non-corrosive environments only.

Caution: Oversized holes in the base material will greatly reduce the anchor's load capacity. For CSD, embedment depths greater than 1 ½" may cause bending during installation.

1. Drill a hole in base material using a ¼"-diameter carbide-tipped drill. Drill hole to specified embedment depth and blow clean using compressed air. (Overhead installation need not be blown clean.) Alternatively, drill hole deep enough to accommodate embedment depth and dust from drilling. Position fixture and insert split-drive anchor through fixture hole.
2. For CSD, ⅜"-diameter fixture hole is recommended for hard fixtures such as steel. For DSD, ⅝"-diameter fixture hole is recommended.
3. Drive anchor until head is flush against fixture.



DSD
(duplex)



CSD
(countersunk)

CSD/DSD Split-Drive Anchors

Installation Sequence

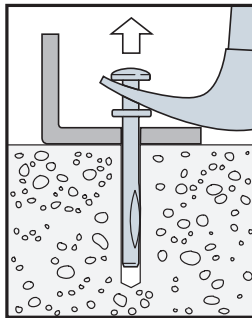
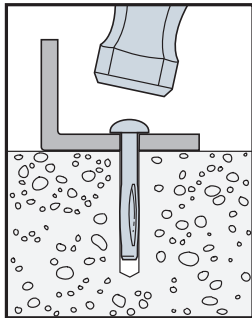
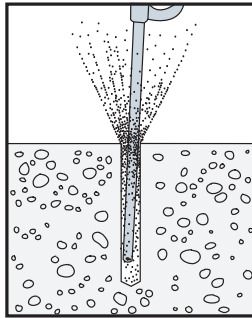
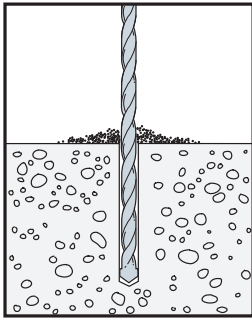

DSD anchor may be removed with a claw hammer.

CSD/DSD Product Data

Size (in.)	Model No.	Head Style / Finish	Drill Bit Diameter (in.)	Quantity	
				Box	Carton
¼ x 1½	CSD25112	Countersunk head – zinc plated	¼	100	500
¼ x 2	CSD25200			100	500
¼ x 2½	CSD25212			100	500
¼ x 3	CSD25300			100	400
¼ x 3½	CSD25312			100	400
¼ x 4	CSD25400			100	400
¼ x 3	CSD25300MG	Countersunk head – mechanically galvanized ¹	¼	100	400
¼ x 4	CSD25400MG			100	400
¼ x 3	DSD25300	Duplex head – zinc plated	¼	100	400

1. Mechanical galvanizing meets ASTM B695, Class 55, Type 1. Intended for some preservative-treated wood sill plate applications. Not for use in other corrosive or outdoor environments. See strongtie.com for details.

Sure Wall Drywall Anchor

Sure Wall anchors are self-drilling drywall anchors and provide excellent holding value and greater capacity than screws alone. This anchor cuts threads into drywall, greatly increasing the bearing surface and strength of the fastening.

Features

- Self-drilling — may be installed in gypsum board drywall with only a screwdriver
- Easy to remove and reinstall

Material: Die-cast zinc or reinforced nylon



Sure Wall
Nylon



Sure Wall
Zinc

Sure Wall Product Data

Screw Size	Model No.		Style	Quantity		Applications
	Packaged with Screws	Packaged without Screws		Box	Carton	
#8 x 1¼"	SWN08LS-R100	SWN08L-R100	Nylon	100	500	¾", ½" drywall, ceiling tile
#8 x 1¼"	SWZ08LS-R100	SWZ08L-R100	Zinc	100	500	¾", ½", ⅜" drywall, plaster

Installation Sequence

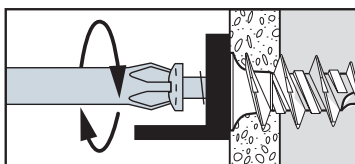
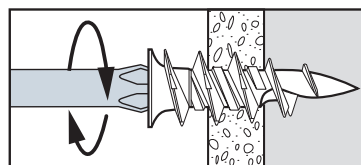
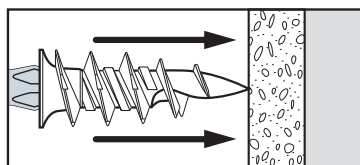



PTP-27L
Automatic
.27 Caliber
1/2 Spot
Made in Taiwan

SIMPSON
Strong-Tie

Direct Fastening Solutions

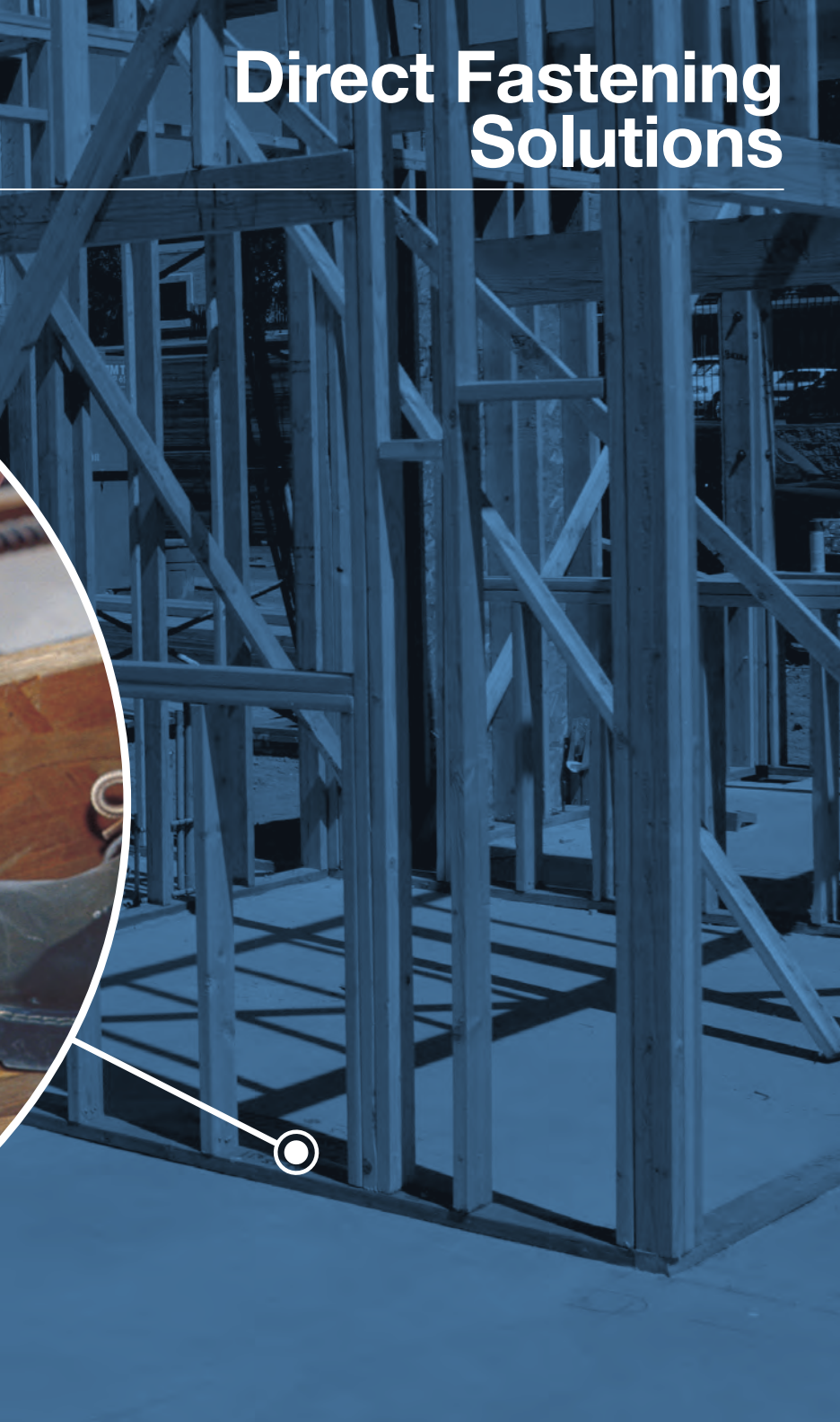







Powder-Actuated Tool / Fastener Suitability

Direct Fastening Solutions

This matrix matches Simpson Strong-Tie powder-actuated tools with the fasteners typically used with each tool.

Fasteners		General-Purpose Tools			
		PTP-27L	PT-27	PT-22A-RB	PT-22HA-RB
0.300"-Headed Fasteners with 0.157" Shank Diameter					
PDPA-XXX		Max. 2½"	Max. 2½"	Max. 2½"	Max. 2½"
PDPAWL-XXX		Max. 3"	Max. 3"	Max. 2½"	Max. 2½"
PDPAS-XXX					
PDPAT-XXX		✓	✓	✓	✓
PCLDPA-XXX		✓	✓	✓	✓
PECLDPA-XXX		✓	✓	✓	✓
PTRHA3-XXX		✓	✓	✓	✓

Powder-Actuated Tool / Fastener Suitability

0.300"-Headed Fasteners with 0.145" Shank Diameter						
PINW-XXX		✓	✓	✓	✓	✓
PINWP-XXX		✓	✓	✓	✓	✓
PHBC-XXX		✓	✓	✓	✓	✓
PCC-XXX		✓	✓	✓	✓	✓
PBXDP-100		✓	✓	✓	✓	✓
8 mm-Headed Fasteners						
PKP-250		✓	✓	✓	✓	✓
3/8"-Headed Fasteners / Threaded Studs						
PSLV3-XXX						

See strongtie.com for more tool and fastener product information.

Gas Tool / Fastener Suitability

Direct Fastening Solutions

Gas Tool
GCN-MEPMAGKT



Fuel Cell
GFCXX



0.106"- Diameter
Shank Pins
GDP
US Patent
605,016



0.118"- /
0.102"- Diameter
Stepped-Shank
Pins
GDPS



Gas Tool / Fastener Suitability

Spiral
Knurl Pins
GDPSK



Mechanical
Electrical
Plumbing Pins



GRH



GCL



GCT



GTS



GCC



GAC



GW



GTH

Direct Fastening Solutions

GCN-MEPMAGKT Gas-Actuated Concrete Nailer

The GCN-MEPMAGKT gas-actuated concrete nailer is a portable fastener tool for attaching light-duty fixtures to concrete, steel, concrete block (CMU), lightweight concrete over metal deck, and cold-formed steel. As a magazine tool, GCN-MEPMAGKT is ideal for attaching drywall track, furring strips, hat track and angle track using GDP and GDPS collated pins.

GCN-MEPMAGKT offers you the flexibility of having two tools in one convenient package — a magazine tool and a single-shot tool, since the magazine is easily removed without additional assembly tools. As a single-shot tool, the GCN-MEPMAGKT is great for attaching mechanical, electrical and plumbing fixtures with pre-assembled pins/accessories such as washer pins, ceiling clips, tophats and threaded studs. The pre-assembled pins for the single-shot tool use 0.300"-headed fasteners with 0.125"-diameter shanks for stronger fastening performance.

Both the single-shot and magazine tool offer portability without the need for cords or hoses, and are actuated with GFC34 gas fuel cells.

Features

- Power to drive 0.125"-diameter pins
- Flexibility to drive ½" to 1½" pins
- Flexibility to drive 0.250" and 0.300" diameter headed pins
- Pin-depth adjustment dial
- Battery charge indicator light
- Comfortable "sure-grip" rubber handle and ladder hook
- Easy start-up procedure: Insert fuel cell, insert battery, load pins, and begin use

**GCN-MEPMAGKT****Specifications**

- Tool dimensions:
 - Length 12.5" (317.5 mm), 17" (432.8 mm)
 - Tool weight: 6.6 lb. (3 kg), 8.3 lb. (3.7 kg) with magazine
 - Height 15.3" (389 mm)
- Compatible fasteners:
 - Length: ½" (12.7 mm) to 1½" (38 mm)
 - Head diameter: 0.250" and 0.300"
 - Shank diameter: 0.106" to 0.125"
- Average number of shots per battery charge: 3,300

- Average number of shots per fuel cell: 1,200
- Average cyclic firing rate: 2 shots per second
- Average battery charge time (6V NiMH): 2 hours
- Operation temperature range: 20°–120°F (–6°–49°C)
- Magazine capacity: 42
- Maximum fastenings before reloading: 40

The magazine is designed to retain two pins during use to prevent the tool from discharging without a fastener (which can damage the tool and possibly cause injury). The tool will resume normal operation when additional pins are loaded.

GCN-MEPMAGKT Gas-Actuated Concrete Nail

Minimum Cleaning Required

The GCN-MEPMAGKT has a very efficient ignition system that provides complete fuel combustion. This results in a cleaner operating tool, which, in turn, results in more tool energy and higher productivity. To maintain maximum level of productivity, periodic cleaning is recommended.

- Only requires cleaning every 20,000 shots
- Easy access to the air filter and piston chamber

The GCN-MEPMAGKT gas-actuated concrete nailer is ideal for fastening:

- Drywall track
- Lath wire for stucco
- Water-proofing membrane
- Furring strips



GCN-MEPMAGKT



Gas-Actuated Concrete Nailing

GDP Pins

GDP concrete pins are designed to work with the GCN-MEPMAGKT gas-actuated concrete nailer as well as with many major-brand gas-actuated concrete-nailer tools. The patented 10-fastener strip is designed with break-away plastic. The pins are designed for use in A36 and A572 steel, concrete, CMU block and sand-lightweight concrete over metal deck.



GDP
US Patent 605,016

Codes: ICC-ES ESR-2811; Florida FL-15730;
City of L.A. RR25837

0.106"-Diameter Shank Drive Pins

Model No.	Length (in.)	Qty. Pins / Pack +1 Fuel Cell	Packs/ Carton	Simpson Strong-Tie® Tool
GDP-50KT	½	1,000	5	GCN-MEPMAGKT
GDP-62KT	⅝	1,000	5	
GDP-75KT	¾	1,000	5	
GDP-100KT	1	1,000	5	
GDP-125KT	1¼	1,000	5	
GDP-150KT	1½	1,000	5	

GDPS Pins

The GDPS pins are also designed to work in the GCN-MEPMAGKT gas-actuated nailer tool for installation into steel and concrete. The step-shank pin, with a smaller-diameter tip, facilitates easier penetration, while the larger-diameter upper shank provides more shear resistance and successful installation.



GDPS

0.118"/0.102"-Diameter Stepped-Shank Drive Pins

Model No.	Length (in.)	Qty. Pins / Pack + 1 fuel cell	Packs/ Carton	Simpson Strong-Tie® Tool
GDPS-50KT	½	1,000	5	GCN-MEPMAGKT
GDPS-62KT	⅝	1,000	5	
GDPS-75KT	¾	1,000	5	

Gas-Actuated Concrete Nailing

Spiral Knurl Gas Pins

GDPSK gas pins are designed for attaching plywood and OSB to cold-formed-steel studs. The spiral knurl provides a positive lock and resists back-out. Installed with the GCN-MEPMAGKT, the GDPSK-138 gas pin provides faster installation and setup times, which contributes to lower labor costs.

The hardened pins quickly and cleanly pierce the cold-formed steel and leave the pin head flush with the wood fixture. The 1 3/8"-length pin can be used for 1/2"-3/4"-thick plywood, and 14-22 gauge steel.



GDPSK

Spiral Knurl Gas Pins

Model No.	Length (in.)	Qty. Pins / Pack + 1 fuel cell	Packs/ Carton	Simpson Strong-Tie® Tool
GDPSK-138KT	1 3/8"	1,000	5	GCN-MEPMAGKT

GWL-100 Lathing Washer and GMR-2 Magnetic Ring

The GWL-100 lathing washer is used with the GCN-MEPMAGKT tool and attaches lath to the wall surface for overlaying scratch coats, brown coats and stucco. The washers are held onto the nose of the tool with the new GMR-2 magnetic ring and are attached to the substrate (including concrete and CMU) with GDP pins, which fasten through the washer. No extra tools are needed to install the magnetic ring to the nosepiece of the tool.



GWL-100

Lathing Washer and Magnetic Ring

Model No.	Description	Pack Quantity	Carton Quantity
GWL-100	Lathing washer, 1" diameter	1,000	5,000
GMR-2	Magnetic ring for GCN-MEPMAGKT	1	900



GMR-2

Lathing washer and magnetic rings are sold separately.

Gas-Actuated Concrete Nailing

Fuel Cell

The GFC34 fuel cell is designed to operate with the GCN-MEPMAGKT and with many major-brand gas-actuated concrete-nailer tools. The fuel cell provides 1,200 shots and can operate at temperatures between 20° and 120°F (–6°–49°C). The fuel cells are offered individually or in a two-per-pack clamshell. Additionally, one fuel cell is included with each pack of 1,000 pins.



GFC Fuel Cell

Gas Fuel Cells for the GCN-MEPMAGKT

Model No.	Description	Pack Quantity	Packs/ Carton	Simpson Strong-Tie® Tool
GFC34	34-gram fuel cells	12	—	GCN-MEPMAGKT
GFC34-RC2	(2) 34-gram fuel cells	2	6	

Gas-Actuated Concrete Nailing

GCN-MEPMAGKT Gas-Actuated Pins and Assemblies for Mechanical, Electrical and Plumbing (MEP) Applications

Pre-assembled MEP fasteners are available for use with the GCN-MEPMAGKT concrete nailer designed for high-volume applications, such as affixing conduit clips, rod hangers, cable ties and ceiling clips.

With their 0.300" heads, these versatile pins and assemblies can also be used with common powder-actuated tools when fastening into harder substrates (structural steel or extra-hard concrete) when required.

Codes: ICC-ES ESR-2811; Florida FL-15730



Mechanical, Electrical and Plumbing Pins

All single-shot pins are 0.125" diameter x 1" except where specified.

Model No.	Description	Pack Quantity	Simpson Strong-Tie® Tool
GRH25-R100	¼" rod hanger with pin	100	GCN-MEPMAGKT
GRH37-R100	⅜" rod hanger with pin	100	
GCC50-R100	½" conduit clip with pin	100	
GCC75-R100	¾" conduit clip with pin	100	
GCC100-R100	1" conduit clip with pin	100	
GCC125-R50	1" conduit clip (13-gauge steel) with pin	50	
GCL50-R50	½" conduit clamp with pin	50	
GCL75-R25	¾" conduit clamp with pin	25	
GAC-R100	Angle clip with pin	100	
GCT-R50	Tie-strap holder with pin	50	
GW50-R200	½" dome washer x ½" step-shank (0.110"/0.128") pin	200	
GW75-R200	½" dome washer with 0.125" x ¾" pin	200	
GW100-R100	½" dome washer with pin	100	
GTS4-5075-R200	¼" threaded stud, ½" length ¼-20 thread, ¾" length shank (0.127" diameter)	200	
GTH-R200	Tophat pin	200	

Extension Pole Tools

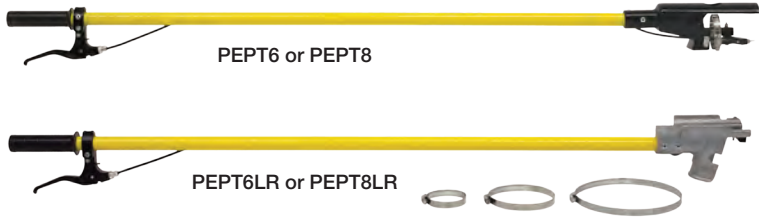

Advantages

- Available in 6' and 8' lengths
- Lightweight
- Eliminates need for scaffolding
- Rugged and durable design

Extension Poles for PT-27





Model	Description	Quantity
PEPT6	Complete 6' pole	1
PEPT8	Complete 8' pole	1

Extension poles for PTP-27L, GCN-MEPMAGKT

Model	Description	Quantity
PEPT6LR	Complete 6' pole	1
PEPT8LR	Complete 8' pole	1

PAT Tool Matrix Powder-Actuated Fastening Systems

This matrix matches Simpson Strong-Tie® powder-actuated tools with the trades that would typically use each tool. The selection is based upon the features of the tool matching the needs of the trade.

Simpson Strong-Tie Powder Actuated Tools				
	PTP-27L	PT-27	PT-22A	PT-22HA
				
Features	<ul style="list-style-type: none"> • Automatic • Adjustable power • Low recoil/noise • 2½" pin capacity (3" pin with washer) 	<ul style="list-style-type: none"> • Semi-automatic • Versatile • Reliable professional-grade tool • 2½" pin capacity (3" pin with washer) 	<ul style="list-style-type: none"> • Single-shot • Economical professional-grade tool • 2½" pin capacity 	<ul style="list-style-type: none"> • Single-shot • Hammer-activated • Medium-duty • 2½" pin capacity
Cold-Formed Steel	Best	Good	Good	
Drywall	Best	Good	Good	Good
Electrical	Best	Better	Good	Good
General	Best	Better	Good	
Framer	Best	Good	Good	
Acoustical/Overhead	Best	Good	Good	Good
Remodeling	Best	Better	Better	Good
Flooring	Best	Good	Good	Good
HVAC	Best	Better	Good	

PTP-27L Premium Tool

The PTP-27L is powder-actuated fastening tool designed to provide versatility and ease of use on the jobsite. This single-shot tool delivers productive fastening with automatic piston reset, which enables the user to simply load and shoot.



PTP-27L



Adjustable power increases versatility

Features

- Adjustable power for fastening versatility: 1–1½ power-level range from a single strip
- Easy disassembly for cleaning and maintenance
- No manual resetting of piston required
- Operator comfort: cushioned grip, reduced recoil and sound-dampening muffler for quiet operation

Key Fastening Applications

- Sill plate installation
- Washered-pin installation
- Insulation fastening
- Forming work
- Cold-formed steel

Specifications

- Fastener Length: ½"–2½" (3" washered)
- Fastener Type: 0.300" (or 8 mm) diameter headed
- Firing Action: Automatic
- Load Caliber: 0.27 strip loads, brown through purple (levels 2–6)
- Length: 17¾"
- Weight: 6.5 lb.

PTP-27L Premium Tool

Tool is sold in a rugged tool box complete with:

- Operator's manual
- Spall suppressor
- Tools for disassembly
- Safety glasses/ear plugs
- Cleaning brushes
- Operator's exam and caution sign
- Gloves
- Five replacement rubber returners



The full line of Simpson Strong-Tie® powder loads and fasteners begins on p. 131.

Replacement Parts – PTP-27L

Description	Model No.
Baseplate	PTP-274810
Fastener Guide	PTP-273820
Piston	PTP-273320
Piston Disc	PTP-273306
Rubber Returner	PTP-274305

Complementary Products

Extension pole tools for the PTP-27L available in 6' and 8' lengths.



Extension pole tools for the PTP-27L — see p. 122 for details.

PT-27 General-Purpose Tool

The PT-27 is a semi-automatic and fast-cycling fastening tool that is engineered for continuous use, high reliability and low maintenance. This versatile tool fires a variety of fastener types and lengths.

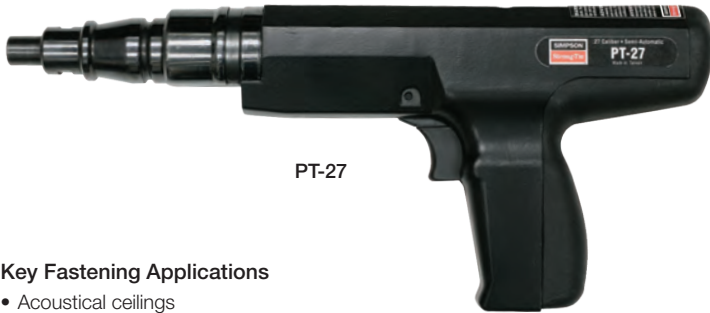

PT-27

Key Fastening Applications

- Acoustical ceilings
- Electrical applications
- Sill plates
- Drywall track
- Water proofing material and/or lathing

Specifications

- Fastener Length: ½"–2½"
(3" washered)
- Fastener Type: 0.300" or
8 mm-headed fasteners or
¼"-20 threaded studs
- Firing Action: Semi-automatic
- Load Caliber: 0.27 strip loads,
brown through red (levels 2–5)
- Length: 13½"
- Weight: 5 lb., 4 oz.

Tool is sold in a rugged tool box complete with

- Operator's manual
- Spall suppressor
- Tools for disassembly
- Safety glasses / ear plugs
- Cleaning brushes
- Operator's exam and
caution sign



The full line of Simpson Strong-Tie® powder loads and fasteners begins on p. 131.

PT-27 General-Purpose Tool

Replacement Parts — PT-27

Description	Model No.
Annular spring	PT-301014
Ball bearing (6 mm)	PT-301013
Barrel	PT-301006
Baseplate	PT-301009
Piston — Flat (includes ring)	PT-301903
Piston ring	PT-301208
Piston stop	PT-301012
Shear clip	PT-301011
Normal wear part replacement kit	PT-27PK1
Tool cleaning kit	PT-MK1

For tool repair and maintenance kits and complete tool schematics and parts list, visit strongtie.com.

Complementary Products

Extension pole tool for the PT-27 available in 6' and 8' lengths.



Extension pole tool for the PT-27 — see p. 122 for details.

PT-22A General-Purpose Tool

The PT-22A is a powder-actuated tool that uses 0.22 caliber "A" crimp loads, has single-shot firing action and is engineered for continuous use, high reliability and low maintenance.



PT-22A-RB

Key Fastening Applications

- Furring strips
- Framing pins
- Electrical boxes
- Ceiling clips

Specifications

- Fastener Length: 2½"
- Fastener Type: 0.300" or 8-mm headed fasteners or ¼"-20 threaded studs
- Firing Action: Single shot
- Load Caliber: 0.22 single "A" crimp loads, brown through yellow (levels 2-4).
Note: Not for use with 0.22-caliber straight wall loads.
- Length: 13⅞"
- Weight: 4.4 lb.

PT-22A-RB Retail Package Product Data

Description	Model No.	Quantity of Tools Per Retail Package	Quantity of Retail Packages Per Carton
0.22-caliber, single-shot trigger-activated tool	PT-22A-RB	1	2

PT-22A General-Purpose Tool

Replacement Parts

Description	Model No.
Piston buffer	PT22A-02
Piston reset cap	PT22A-13
Piston reset pin	PT22A-11
Piston reset spring	PT22A-12
Piston with ring	PT22A-03

1. Complete tool schematics and parts list available at strongtie.com.



PT-22A-RB

The full line of Simpson Strong-Tie® powder loads and fasteners begins on p. 131.

PT-22HA General-Purpose Tool

The PT-22HA is a hammer-activated tool engineered for low maintenance and economy. The tool offers three levels of power: Brown through yellow loads (levels 2–4).



PT-22HA-RB

Key Fastening Applications

- Remodeling
- Maintenance
- Electricians
- Telecommunications

Specifications

- Fastener Length: ½"–2½"
- Fastener Type: 0.300" or 8 mm-headed fasteners or ¼" -20 threaded studs
- Firing Action: Single shot, hammer activated
- Load Caliber: 0.22 single "A" crimp loads, brown through yellow (levels 2–4). Note: Not for use with 0.22-caliber straight wall loads.
- Length: 14¼"
- Weight: 2 lb., 12 oz.



PT-22HA-RB Retail Package Product Data

Description	Model No.	Quantity of Tools Per Retail Package	Quantity of Retail Packages Per Carton
0.22-caliber, single-shot hammer-activated tool	PT-22HA-RB	1	4



The PT-22HA-RB comes packaged in a retail clamshell ready for merchandising.

Powder Loads for Powder-Actuated Tools

0.22-Caliber "A" Crimp Loads — Single Shot

Description	Model	Pack Quantity	Carton Quantity	Simpson Strong-Tie® Tools
0.22 cal. — Brown (Level 2)	P22AC2	100	10,000	PT-22A PT-22HA
	P22AC2A	100	10,000	
0.22 cal. — Green (Level 3)	P22AC3	100	10,000	
	P22AC3A	100	10,000	
0.22 cal. — Yellow (Level 4)	P22AC4	100	10,000	
	P22AC4A	100	10,000	



P22AC

Note: An "A" in a part number denotes imported load.
No "A" indicates a domestic load.

0.25-Caliber Plastic 10-Shot Strip Loads

Description	Model	Pack Quantity	Carton Quantity
0.25 cal. — Green (Level 3)	P25SL3	100	10,000
0.25 cal. — Green Bulk pack	P25SL3M	1,000	5,000
0.25 cal. — Yellow (Level 4)	P25SL4	100	10,000
0.25 cal. — Yellow Bulk pack	P25SL4M	1,000	5,000
0.25 cal. — Red (Level 5)	P25SL5	100	10,000
0.25 cal. — Red Bulk pack	P25SL5M	1,000	5,000



P25SL

Powder Loads for Powder-Actuated Tools

0.27-Caliber Single-Shot Loads — Long

Description	Model	Pack Quantity	Carton Quantity
0.27 cal. — Yellow (Level 4)	P27LVL4	100	10,000
0.27 cal. — Red (Level 5)	P27LVL5	100	10,000
0.27 cal. — Purple (Level 6)	P27LVL6	100	10,000



P27LVL

0.27-Caliber Plastic, 10-Shot Strip Loads

Description	Model	Pack Quantity	Carton Quantity	Simpson Strong-Tie® Tool
0.27 cal. — Brown (Level 2)	P27SL2	100	10,000	PTP-27L
	P27SL2A	100	10,000	
0.27 cal. — Green (Level 3)	P27SL3	100	10,000	
	P27SL3A	100	10,000	
0.27 cal. — Green Bulk pack	P27SL3M	1,000	5,000	
0.27 cal. — Yellow (Level 4)	P27SL4	100	10,000	
	P27SL4A	100	10,000	
0.27 cal. — Yellow Bulk pack	P27SL4M	1,000	5,000	
0.27 cal. — Red (Level 5)	P27SL5	100	10,000	
	P27SL5A	100	10,000	
0.27 cal. — Red Bulk pack	P27SL5M	1,000	5,000	
0.27 cal. — Purple (Level 6)	P27SL6	100	10,000	

Note: An "A" in a part number denotes imported load. No "A" indicates a domestic load.



P27SL

Fasteners for Powder-Actuated Tools

PDPA Drive Pins

- Manufactured with tight tolerances for superior performance
- Code listed per ICC-ES ESR-2138; City of L.A. RR25469; Florida FL-15730

0.300"-Headed Fasteners with 0.157" Shank Diameter

Length (in.)	Model No.	Description	Pack Qty.	Carton Qty.	Simpson Strong-Tie® Tools
½	PDPA-50	0.157" x ½"	100	1,000	PTP-27L PT-27 PT-22A PT-22HA
½ knurled	PDPA-50K	0.157" x ½" knurl	100	1,000	
⅝ knurled	PDPA-62K	0.157" x ⅝" knurl	100	1,000	
¾	PDPA-75	0.157" x ¾"	100	1,000	
1	PDPA-100	0.157" x 1"	100	1,000	
1 1/16	PDPA-106	0.157" x 1 1/16"	100	1,000	
1 ¼	PDPA-125	0.157" x 1 ¼"	100	1,000	
1 5/16	PDPA-131	0.157" x 1 5/16"	100	1,000	
1 ½	PDPA-150	0.157" x 1 ½"	100	1,000	
1 7/8	PDPA-187	0.157" x 1 7/8"	100	1,000	
2	PDPA-200	0.157" x 2"	100	1,000	
2 ½	PDPA-250	0.157" x 2 ½"	100	1,000	
2 7/8	PDPA-287	0.157" x 2 7/8"	100	1,000	

These models available in mechanically galvanized finish (PDPA-250MG and PDPA-287MG).



PDPA

Fasteners for Powder-Actuated Tools

0.300"-Headed Fasteners with
0.157" Shank Diameter and 1" Metal Washers

Length (in.)	Model No.	Description	Pack Qty.	Carton Qty.	Simpson Strong-Tie® Tools
½	PDPAWL-50	0.157" x ½", with 1" washer	100	1,000	PTP-27L PT-27 PT-22A PT-22HA
½ knurled	PDPAWL-50K	0.157" x ½" knurl, with 1" washer	100	1,000	
¾	PDPAWL-75	0.157" x ¾", with 1" washer	100	1,000	
1	PDPAWL-100	0.157" x 1", with 1" washer	100	1,000	
1¼	PDPAWL-125	0.157" x 1¼", with 1" washer	100	1,000	
1½	PDPAWL-150	0.157" x 1½", with 1" washer	100	1,000	
1⅞	PDPAWL-187	0.157" x 1⅞", with 1" washer	100	1,000	
2	PDPAWL-200	0.157" x 2", with 1" washer	100	1,000	
2¼	PDPAWL-225	0.157" x 2¼", with 1" washer	100	1,000	
2½	PDPAWL-250	0.157" x 2½", with 1" washer	100	1,000	
2⅞	PDPAWL-287	0.157" x 2⅞", with 1" washer	100	1,000	

These models available in mechanically galvanized finish (PDPAWL-200MG, PDPAWL-250MG and PDPAWL-287MG).



0.300"-Headed Fasteners with
0.157" Shank Diameter — 10-Pin Collation

Length (in.)	Model No.	Description	Pack Qty.	Carton Qty.
½	PDPAS-50	0.157" x ½"	100	1,000
½ knurled	PDPAS-50K	0.157" x ½" knurl	100	1,000
⅝ knurled	PDPAS-62K	0.157" x ⅝" knurl	100	1,000
¾	PDPAS-75	0.157" x ¾"	100	1,000
1	PDPAS-100	0.157" x 1"	100	1,000
1¼	PDPAS-125	0.157" x 1¼"	100	1,000
1½	PDPAS-150	0.157" x 1½"	100	1,000
1⅞	PDPAS-187	0.157" x 1⅞"	100	1,000
2	PDPAS-200	0.157" x 2"	100	1,000
2½	PDPAS-250	0.157" x 2½"	100	1,000
2⅞	PDPAS-287	0.157" x 2⅞"	100	1,000



Fasteners for Powder-Actuated Tools

0.300"-Headed Tophat Fasteners
with 0.157" Shank Diameter

Length (in.)	Model No.	Description	Pack Qty.	Carton Qty.	Simpson Strong-Tie® Tools
½ knurled	PDPAT-50K	0.157" x ½" knurl	100	1,000	PTP-27L PT-27 PT-22A PT-22HA
⅝ knurled	PDPAT-62K	0.157" x ⅝" knurl	100	1,000	
¾	PDPAT-75	0.157" x ¾"	100	1,000	
1	PDPAT-100	0.157" x 1"	100	1,000	



PDPAT

Pre-Assembled Ceiling Clips —
0.300"-Headed Fasteners with 0.157" Shank Diameter

Length (in.)	Model No.	Description	Pack Qty.	Carton Qty.	Simpson Strong-Tie® Tools
⅞	PCLDPA-87	Ceiling clip with ⅞" pin	100	1,000	PTP-27L PT-27 PT-22A PT-22HA
1⅛	PCLDPA-106	Ceiling clip with 1⅛" pin	100	1,000	
1⅝	PCLDPA-131	Ceiling clip with 1⅝" pin	100	1,000	
1⅞	PECLDPA-106	Compact ceiling clip with 1⅞" pin	100	1,000	
1⅞	PECLDPA-131	Compact ceiling clip with 1⅞" pin	100	1,000	



PCLDPA



PECLDPA

Threaded Rod Hangers —
0.300"-Headed Fasteners with 0.157" Shank Diameter

Length (in.)	Model No.	Description	Pack Qty.	Carton Qty.	Simpson Strong-Tie® Tools
1⅝, ¼ — 20 threaded rod hanger	PTRHA4-131	0.157" x 1⅝"	50	500	PTP-27L PT-27 PT-22A PT-22HA
1⅝, ⅜ — 16 threaded rod hanger	PTRHA3-131	0.157" x 1⅝"	50	500	



PTRHA3

Fasteners for Powder-Actuated Tools

0.300"-Headed Fasteners with
0.145" Shank Diameter and 1 $\frac{7}{16}$ " Metal Washers

Length (in.)	Model No.	Pack Qty.	Carton Qty.	Simpson Strong-Tie® Tools
1½	PINW-150	50	500	PTP-27L PT-27 PT-22A PT-22HA
2	PINW-200	50	500	
2½	PINW-250	50	500	
3	PINW-300	50	500	



PINW

0.300"-Headed Fasteners with 0.145" Shank Diameter
and 1 $\frac{3}{8}$ " Plastic White Washers

Length (in.)	Model No.	Pack Qty.	Carton Qty.	Simpson Strong-Tie® Tools
1	PINWP-100W	50	500	PTP-27L PT-27 PT-22A PT-22HA
1½	PINWP-150W	50	500	
1¾	PINWP-175W	50	500	
2	PINWP-200W	50	500	
2½	PINWP-250W	50	500	
3	PINWP-300W	50	500	



PINWP

These models available with inverted plastic washer (PINWP-150MF and PINWP-250MF).

Highway Basket Clips —

0.300"-Headed Fasteners with 0.145" Shank Diameter

Description	Model No.	Pack Qty.	Carton Qty.	Simpson Strong-Tie® Tools
Clip with 1½" pin	PHBC-150	100	1,000	PTP-27L PT-27 PT-22A PT-22HA
Clip with 2" pin	PHBC-200	100	1,000	
Clip with 2½" pin	PHBC-250	50	500	



PHBC

Fasteners for Powder-Actuated Tools

Pre-Assembled BX Cable Straps and Conduit Straps —
0.300"-Headed Fasteners with 0.145" Shank Diameter

Description	Model No.	Pack Qty.	Carton Qty.	Simpson Strong-Tie® Tools
BX cable strap with 1" pin	PBXDP-100	100	1,000	PTP-27L PT-27 PT-22A PT-22HA
Conduit clip ½" EMT with 1" pin	PCC50-DP100	100	1,000	
Conduit clip ¾" EMT with 1" pin	PCC75-DP100	50	500	
Conduit clip 1" EMT with 1" pin	PCC100-DP100	50	500	



PCC



PBXDP

¾" — 16 Threaded Studs*
(Factory Mutual Listing — see below)

Length (in.)	Model No.	Pack Qty.	Carton Qty.	Simpson Strong-Tie Tools
¾" — 16 knurled (T-1¼, S-¾)	PSLV3-12575K	100	1,000	—
¾" — 16 (T-1¼, S-1)	PSLV3-125100	100	1,000	
¾" — 16 (T-1¼, S-1¼)	PSLV3-125125**	100	1,000	



PSLV3



*Shank diameter is 0.205". NOTE: T = thread length, S = shank length.

**Factory Mutual Listing 3031724

Fasteners for Powder-Actuated Tools

Concrete Forming Pin —
0.187"-Headed with 0.145" Shank Diameter

Length (in.)	Model No.	Pack Qty.	Carton Qty.	Simpson Strong-Tie® Tools
3/16 x 2 1/2 concrete forming pin	PKP-250	100	1,000	PTP-27L PT-27 PT-22A PT-22HA

Note: Lengths in inches are for reference only and may not be exact.



PKP

Miscellaneous

1/4"-Headed Hammer Drive Fastener with 3/8" Metal Washer

Length (in.)	Model No.	Pack Qty.	Carton Qty.	Simpson Strong-Tie® Tools
3/4	PHD-75	100	1,000	PHT-38
1	PHD-100	100	1,000	
1 1/4	PHD-125	100	1,000	



PHD

Manual Hammer Tool

(not for use with powder loads)



PHT-38



Warning: Do not use powder loads with this tool. This is a hammer drive tool only. Use of powder loads with this tool may result in injury or death.

Gas- and Powder-Actuated Fastening Safety Principles

Before operating any Simpson Strong-Tie® gas- or powder-actuated tool, you must read and understand the Operator's Manual and be trained by an authorized instructor in the operation of the tool. Simpson Strong-Tie highly recommends you read and fully understand the safety guidelines of the tool you use. You must then pass a test and receive a certified operator card to become a Certified Operator. The test and Operator's Manual are included with each tool kit, or certification can be obtained by taking the test online at strongtie.com.

GENERAL SAFETY

To avoid serious injury or death:

- ALWAYS make sure that the operator and bystanders wear safety glasses. Hearing and head protection are also recommended.
- ALWAYS post warning signs when gas- or powder-actuated tools are in use. Signs should state "Tool in Use" and should be posted within the area where the tool is being used.
- ALWAYS store gas- or powder-actuated tools unloaded. Tools, loads and gas cells should be stored in a locked container out of the reach of children.
- NEVER place any part of your body over the front muzzle of the tool even if no fastener is present. The fastener, pin or tool piston can cause serious injury or death in the event of an accidental discharge.
- NEVER transport fasteners or other hard objects in the same pocket or container with powder loads or fuel cells. These objects may strike the powder loads or puncture the fuel cell, thereby setting them off and causing serious injury or death.
- NEVER attempt to bypass or circumvent any of the safety features on a gas- or powder-actuated tool.
- ALWAYS keep the tool pointed in a safe direction.
- ALWAYS keep your finger off the trigger until ready to shoot.
- ALWAYS keep the tool unloaded until ready to use.

INSTALLATION SAFETY

To avoid serious injury or death:

- ALWAYS hold the tool perpendicular (90°) to the fastening surface to prevent ricocheting fasteners. Use the spill guard whenever possible.
- NEVER attempt to fasten to soft, thin, brittle or very hard materials such as drywall, light gauge steel, glass, tile or cast iron as these materials are inappropriate. Conduct a pre-punch test to determine base material adequacy.
- NEVER attempt to fasten to soft material like wood or drywall (fastening through soft materials into an appropriate base material may be allowed if the application is appropriate).
- NEVER attempt to fasten to a spalled, cracked or uneven surface.



Safety equipment, such as safety glasses and ear plugs, is recommended when using gas- or powder-actuated tools.



Restoration Solutions

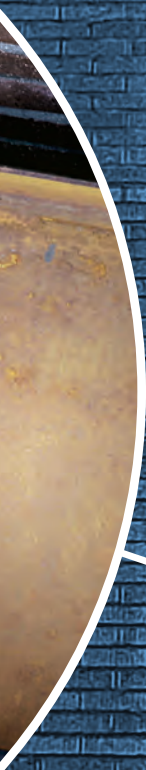

ETI Injection Epoxy

ETI injection epoxies are two-component, high-solids formulations for the injection into cracks in concrete. Dispensed through a static mixing nozzle using either a manual, battery-powered or a pneumatic dispensing tool, these epoxies provide a waterproof, high strength (structural) repair.



ETI-SLV

ETI-LV

ETI-GV

Features

- Bonds chemically to concrete, providing load-bearing applications (meets the requirements of ASTM C 881 for structural repair epoxy)
- Formulated for maximum penetration under pressure (all viscosities)
- Seals out moisture, protecting rebar in the concrete from corrosion and flooring from moisture damage
- Reliable mixing and ratio control when used with the Simpson Strong-Tie® Optimix® static mixing nozzle (included with cartridge)
- Suitable for pressure injection
- Non-shrink material resists oils, salts and mild chemicals

ETI-SLV Super-Low-Viscosity Epoxy

- Super-low viscosity (350 cP) repairs hairline cracks (0.002") and cracks up to 1/4" in width
- Penetrates smallest cracks

ETI-LV Low-Viscosity Epoxy

- Repairs fine to medium cracks 1/64" to 1/4" in width
- Offers low surface tension to effectively penetrate narrow cracks
- Approved under NSF/ANSI standard 61

ETI-GV Gel-Viscosity Epoxy

- Gel-viscosity (non-sag) epoxy repairs medium cracks 3/32"-1/4" in width
- Decreases in viscosity under pressure, increasing flow
- Suitable for use as pick-proof sealant around doors, windows and fixtures

ETI Injection Epoxy

Application Considerations

- Suitable for repairing non-moving cracks in concrete walls, floors, slabs, columns and beams.
- ETI can be used to inject cracks in damp or wet conditions (non-seeping or non-leaking conditions only) with excellent results.
- Apply to concrete 40°F or above. For best results, warm material to 60°F or above prior to application.
- Mixed material in nozzle and injection fitting hardens in 15 minutes (ETI-SLV), and in 60 minutes (ET-LV, ETI-GV) at temperatures of 40°F or above.

ETI Cartridge System¹

Model No.	Capacity ounces (cubic in.)	Dispensing Tool	Mixing Nozzle
ETISLV	16.5 (29.8)	EDT22S	EMN022 (included)
ETILV22	22 (39.7)		
ETIGV22			

1. Bulk containers also available. Contact Simpson Strong-Tie for details.
2. Use only appropriate Simpson Strong-Tie® mixing nozzles in accordance with Simpson Strong-Tie instructions. Modification or improper use of mixing nozzle may impair epoxy performance.
3. EDT22s tool must be configured for 2:1 cartridge ratio.

Crack-Pac® Injection Epoxy

The Crack-Pac injection epoxy is designed to repair cracks in concrete ranging from 1/64" to 1/4" wide in concrete walls, floors, slabs, columns and beams. The mixed adhesive has the viscosity of a light oil and a low surface tension, allowing it to penetrate fine to medium-width cracks in dry, damp or wet conditions with excellent results. Resin is contained in the cartridge and hardener is contained in the nozzle.

Features

- Dispenses with a standard caulking tool, no special dispensing tool needed
- Clean and easy to mix
- Seals out moisture, protecting rebar in the concrete from corrosion and flooring from moisture damage
- Chemically bonds with the concrete to restore strength
- Non-shrink material resistant to oils, salts and mild chemicals
- Meets the requirements of AASHTO M-235 and ASTM C881, Type I, Grade 1, Class C

Application Considerations

- Suitable for repair of cracks ranging from 1/64" to 1/4" wide in concrete walls, floors, slabs, columns and beams.
- Can be used to inject cracks in dry, damp or wet conditions with excellent results. Not for use in actively leaking cracks.
- In order for components to mix properly, the resin and hardener must be conditioned to 60°F–80°F (16°C–27°C) before mixing.

Shelf Life: 24 months from date of manufacture, unopened

Usage Temperature: 60°F–90°F (16°C–32°C)



Crack-Pac Injection Epoxy (ETIPAC10)

Dispensing Systems:
US Patents 6,737,000
and 6,896,001 B2

Crack-Pac® Injection Epoxy



**Crack-Pac Kit
(ETIPAC10KT)**

Crack-Pac injection epoxy is also available in the Crack-Pac Injection Kit (ETIPAC10KT). The kit includes everything needed to pressure inject cracks.

- Two Crack-Pac cartridge/nozzle sets (ETIPAC10)
- 12 E-Z-Click injection ports
- Two E-Z-Click injection fittings with 12" tubing
- One pint of ETR paste-over epoxy (8 oz. of resin + 8 oz. of hardener)
- Four disposable wood paste-over applicators
- One pair latex gloves

Crack-Pac Cartridge System

Model No.	Capacity (ounces)	Cartridge Type	Carton Quantity	Dispensing Tool
ETIPAC10	9	Single	12	CDT10S
ETIPAC10KT	18	Single	2 (kits)	

Crack-Pac® Flex-H₂O™ Polyurethane Crack Sealer

The Crack-Pac Flex-H₂O polyurethane injection resin seals leaking cracks, voids or fractures from 1/32" to 1/4" wide in concrete or solid masonry. Designed to perform in applications where water is seeping or mildly leaking from the crack, the polyurethane is packaged in the cartridge and an accelerator is packaged in the nozzle. When the resin encounters water as it is injected into the crack, it becomes an expanding foam that provides a flexible seal in leaking and non-leaking cracks.

Features

- Can be dispensed with a standard caulking tool
- Can also be used on dry cracks if water is introduced to affected area
- Can be used with a reduced amount or without accelerator to slow down reaction time
- Expands to fill voids and seal the affected area
- Fast reacting — reaction begins within one minute after exposure to moisture; expansion may be completed within three minutes (depending on the amount of moisture and the ambient temperature)
- 20:1 expansion ratio (unrestricted rise) means less material needed

Application Considerations

- Suitable for sealing cracks ranging from 1/32" to 1/4" wide in concrete and solid masonry.
- Suitable for repair of cracks in dry, damp and wet conditions with excellent results. Designed to perform in applications where water is seeping or mildly leaking from the crack.
- In order for components to mix properly, the resin and hardener must be conditioned to 60°F–90°F (16°C–32°C) before mixing.

Shelf Life: 12 months from date of manufacture, unopened

Usage Temperature: 60°F–90°F (16°C–32°C)



**Crack-Pac Flex-H₂O
Crack Sealer
(CPFH09)**

Dispensing System:
US Patents
6,737,000 and
6,896,001 B2

Crack-Pac® Flex-H₂O™ Polyurethane Crack Sealer

Crack-Pac Flex-H₂O Kit
(CPFH09KT)

Crack-Pac Flex-H₂O injection epoxy is also available in the Crack-Pac Flex-H₂O Injection Kit (CPFH09KT). The kit includes everything needed to pressure inject cracks.

- Two Crack-Pac Flex-H₂O cartridge/nozzle sets (CPFH09)
- 12 E-Z-Click injection ports
- Two E-Z-Click injection fittings with 12" tubing
- One pint of ETR paste-over epoxy (8 oz. of resin + 8 oz. of hardener)
- Four disposable wood paste-over applicators
- One pair latex gloves

Crack-Pac Flex-H₂O Packaging

Model No.	Capacity	Cartridge Type	Carton Quantity	Dispensing Tool
CPFH09	9 ounces	Single	12	CDT10S
CPFH09KT	18 ounces	Single	2 (kits)	
FH05 ¹	5 gallons resin	Pail	1	—
	16 ounces catalyst			

1. For standard reaction time, use 30:1 resin to catalyst ration.

For a faster reaction time, add more catalyst; for a slower reaction time, use less.

CIP / ETR Paste-Over and Crack Sealants

CIP and ETR are 1:1 two-component, high-solids, epoxy-amine-based adhesive that are fast-curing epoxies used to paste-over and seal cracks while securing injection ports to the surface of concrete substrates prior to injecting an epoxy or urethane crack repair product.

Features

- Mixed material is a uniform gray color
- Non-sag paste consistency for horizontal, vertical or overhead applications
- Fast cure times for shorter times between paste-over and injection
- When properly mixed, the products will be a uniform gray color and can be left in place or removed after the repair is complete

CIP-LO Low Odor Paste-Over Epoxy and Crack Sealant

- Low odor formulation
- Strong substrate bond; requires chipping to remove
- Gel Time — six minutes at 72°F (22°C), 28 minutes at 40°F (4°C)
- Cure Time — 75 minutes at 72°F (22°C), two hours at 60°F (16°C) and 4–5 hours at 40°F (4°C)
- Volatile organic compound (VOC) — 4 g/L
- Available in a 22 oz. side-by-side cartridge

CIP-F Flexible Paste-Over Adhesive and Crack Sealant

- Remains flexible after cure for easier removal
- Moderate substrate bond; peels away for removal
- Gel Time — four minutes at 72°F (22°C), 9 minutes at 40°F (4°C)
- Cure Time — one hour at 72°F (22°C), and three hours at 40°F (4°C)
- Volatile organic compound (VOC) — 0 g/L
- Available in a 22 oz. side-by-side cartridge



CIP-LO



CIP-F

CIP / ETR Paste-Over and Crack Sealants

ETR Concrete Repair and Paste-Over Epoxy

- Canisters are mixed manually and do not require dispensing tool
- Each package contains enough material to cover approximately eight lineal feet of cracks
- Volatile organic compound (VOC) — 7 g/L
- Available in two 8 fl. oz. canisters



ETR16

Application Considerations

- Apply to concrete 40°F (4°C) or above. For best results, warm material to 65°F (16°C) or above prior to application.

Shelf Life:

CIP-LO and ETR — 24 months from date of manufacture, unopened.

CIP-F — 12 months from date of manufacture, unopened.

Paste-Over and Crack Sealants

Model No.	Capacity (oz.)	Cartridge	Mixing Nozzle	Dispensing Tool	Package Quantity	Carton Quantity
CIPLO22	22	Side-by-side	EMN22I	EDT22S, EDTA22CKT	1	10
CIP-F22 ¹	22	Side-by-side	EMNCIPF22	EDTA22P	1	10
ETR16	16	—	—	—	1	4

1. One EMNCIPF22 mixing nozzle is supplied with each cartridge.

Crack Repair Accessories



EMN022 Optimix®
Mixing Nozzle

Mixing Nozzles

Model No.	Description	Package Quantity	Carton Quantity
EMNCIPF22-RP5	Mixing nozzle for CIPF-22 epoxy	5	25
EMN022-RP6	Optimix mixing nozzle for ETI epoxies	6	30

1. Use only appropriate Simpson Strong-Tie® mixing nozzle in accordance with Simpson Strong-Tie instructions. Modification or improper use of mixing nozzle may impair epoxy performance.
2. Includes retaining nuts.



E-Z-Click
Ports and Injection Fitting



EIPX-EZ
Corner-Mount/
Drilled-In Port



EIP-EZA
Flush-Mount
Port

Injection Ports and Injection Fittings

Model No.	Description	Package Contents		Carton Quantity
		Ports	E-Z Click Injection Fitting	
EIP-EZAKT	E-Z Click flush-mount injection ports	20	1	5 kits
EIP-EZA		1 each	—	100
EIPX-EZKT	E-Z Click corner-mount or drilled-in injection port	20	1	5 kits
EIPX-EZ-RP20		20	—	100 (5 packs)
EIP-EZ	E-Z Click injection fitting	—	1 each	10

1. EIPX intended for use as a surface-mount port in corners and as a drilled-in port on flat surfaces.

Detailed information on the full line of Simpson Strong-Tie manual and pneumatic dispensing tools is available on strongtie.com.

Crack Injection Guide



Important: These instructions are intended as recommended guidelines. Due to the variability of field conditions, selection of the proper material for the intended application and installation is the sole responsibility of the applicator.

Epoxy injection is an economical method of repairing non-moving cracks in concrete walls, slabs, columns and piers and is capable of restoring the concrete to its pre-cracked strength. Prior to doing any injection it is necessary to determine the cause of the crack. If the source of cracking has not been determined and remedied, the concrete may crack again.

Materials

- ETI-SLV for repair of hairline cracks (0.002") and those up to 1/4" in width.
- ETI-LV for repair of fine to medium-width cracks (Suggested width range: 1/64"–1/4").
- ETI-GV for repair of medium-width cracks (Suggested width range: 3/32"–1/4").
- Crack-Pac® injection epoxy for repair of fine to medium non-structural cracks (Suggested width range: 1/64"–1/4").
- Crack-Pac Flex-H₂O polyurethane crack sealer for repair of fine- to medium-width cracks (Suggested width range: 1/32"–1/4").
- CIP-LO, CIP-F and ETR are recommended for paste-over of crack surface and installation of injection ports. ET-HP, ETR or SET adhesives may also be used as a substitute. (SET is the only paste-over epoxy approved for NSF/ANSI Standard 61.)
- E-Z-Click™ injection ports, fittings and other suitable accessories.

Crack Injection Guide

Estimating Guide for Epoxy Crack Injection

Width of Crack (in.)	Concrete Thickness (in.)	ETI-LV ETI-GV	ETI-SLV	Crack-Pac	Crack-Pac Flex-H ₂ O
		Approx. Coverage per 22 oz. Cartridge (linear ft.)	Approx. Coverage per 16.5 oz. Cartridge (linear ft.)	Approx. Coverage per 9 oz. Cartridge (linear ft.)	Approx. Coverage per 9 oz. Cartridge (linear ft.)
1/64	4	47.7	35.7	18.4	—
	6	31.8	23.8	12.3	—
	8	23.8	17.9	9.2	—
	10	19.1	14.3	7.4	—
1/32	4	23.8	17.9	9.2	108.0
	6	15.9	11.9	6.1	72.0
	8	11.9	8.9	4.6	54.0
	10	9.5	7.1	3.7	43.2
1/16	4	11.9	8.9	4.6	54.0
	6	7.9	6.0	3.1	36.0
	8	6.0	4.5	2.3	27.0
	10	4.8	3.6	1.8	21.6
1/8	4	6.0	4.5	2.3	27.0
	6	4.0	3.0	1.5	18.0
	8	3.0	2.2	1.2	13.5
	10	2.4	1.8	0.9	10.8
3/16	4	4.0	3.0	1.5	18.0
	6	2.6	2.0	1.0	12.0
	8	2.0	1.5	0.8	9.0
	10	1.6	1.2	0.6	7.2
1/4	4	3.0	2.2	1.2	13.5
	6	2.0	1.5	1.8	9.0
	8	1.5	1.1	0.6	6.8
	10	1.2	0.9	0.5	5.4

Coverage listed is approximate and will vary depending on waste and condition of concrete.

Crack Injection Guide

Preparation of the Crack for Injection

Clean the crack and the surface surrounding it to allow the paste-over to bond to sound concrete. At a minimum, the surface to receive paste-over should be brushed with a wire brush. Oil, grease or other surface contaminant must be removed in order to allow the paste-over to bond properly. Take care not to impact any debris into the crack during cleaning. Using clean, oil-free compressed air, blow out the crack to remove any dust, debris or standing water. Best results will be obtained if the crack is dry at the time of injection. If water is continually seeping from the crack, the flow must be stopped in order for epoxy injection to yield a suitable repair. Other materials such as polyurethane resins may be required to repair an actively leaking crack.

For many applications, additional preparation is necessary in order to seal the crack. Where a surfacing material has been removed using an acid or chemical solvent, prepare the crack as follows:

1. Using clean, compressed air, blow out any remaining debris and liquid.
2. Remove residue by high-pressure washing or steam cleaning.
3. Blow any remaining water from the crack with clean compressed air.

If a coating, sealant or paint has been applied to the concrete, it must be removed before placing the paste-over epoxy. Under the pressure of injection, these materials may lift and cause a leak. If the surface coating is covering the crack, it may be necessary to route out the opening of the crack in a "V" shape using a grinder in order to get past the surface contamination.

Crack Injection Guide

Sealing of the Crack and Attachment of E-Z-Click™ Injection Ports

1. To adhere the port to the concrete, apply a small amount of paste-over around the bottom of the port base (Picture 1). Place the port at one end of the crack and repeat until the entire crack is ported (Picture 2). As a rule of thumb, injection ports should be placed 8" apart along the length of the crack.

Important: Do not allow paste-over to block the port or the crack under it; this is where the injection epoxy must enter the crack.

2. Using a putty knife or other paste-over tool, generously work paste-over along the entire length of the crack (Picture 3). Take care to mound the paste-over around the base of the port to approximately ¼" thick extending 1" out from the base of the port and to work out any holes in the material. It is recommended that the paste-over should be a minimum of ⅜" thick and 1" wide along the crack. Insufficient paste-over will result in leaks under the pressure of injection. If the crack passes completely through the concrete element, seal the back of the crack, if possible. If not, epoxy may be able to run out the back side of the crack, resulting in an ineffective repair.

3. Allow the paste-over to harden before beginning injection.

Note: CIP-LO, CIP-F and ETR epoxies are fast-cure materials and may harden prematurely if left in a mixed mass on the mixing surface while installing ports. Spreading paste-over into a thin film (approximately ⅛") on the mixing surface will slow curing by allowing the heat from the reaction to dissipate.

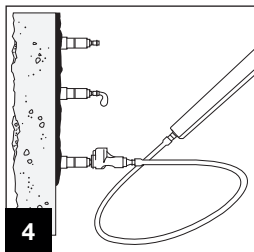
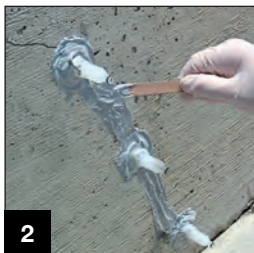

While this method may appear to leave some ports uninjected, it provides maximum pressure to force the epoxy into the smaller areas of the crack. Moving to the next port as soon as epoxy appears will allow the epoxy to travel along the wider parts of the crack to the next ports rather than force it into the crack before it travels to the next ports.

Crack Injection Guide

Injection Procedure for ETI-SLV, ETI-LV, ETI-GV and Crack-Pac® Injection Epoxy

1. Follow cartridge preparation instructions on the cartridge label. Verify that the material flowing from the Optimix® mixing nozzle is a uniform and consistent color: for ETI-SLV, the mixed product is black; ETI-LV is transparent amber; and ETI-GV is grey. For Crack-Pac injection epoxy, verify that the mixed material in the cartridge is a transparent amber color.
2. Attach the E-Z-Click™ fitting to the end of the nozzle by pushing the tubing over the barbs at the end of the nozzle. Make sure that all ports are pushed in to the open position.
3. Attach the E-Z-Click injection fitting to the first E-Z-Click port until it clicks into place. Make sure that the heads of all the ports are pushed in to the open position. In vertical applications, begin injection at the lowest port and work your way up. In a horizontal application, start at one end of the crack and work your way to the other end.
4. Inject epoxy into the first port until it will no longer flow into the crack. If epoxy shows at the next port and the first port still accepts material, close the second port and continue to inject into the first port until it accepts no more epoxy. Continue closing ports where epoxy appears until the first port refuses epoxy. When the first port reaches the point of refusal, brace the base of the port and pull out gently on the head of the port to close it. Pulling too hard may dislodge the port from the surface of the concrete, causing a leak. Depress the metal tab on the head of the E-Z-Click fitting and remove it from the port.
5. Go to the last port where epoxy appeared while injecting the first port, open it, and continue injection at this port. If the epoxy has set up and the port is bonded closed, move to the next clean port and repeat the process until every portion of the crack has refused epoxy.

Injection Tips

- If using a pneumatic dispensing tool, set the tool at a low setting when beginning injection and increase pressure if necessary to get the epoxy to flow.
- For narrow cracks, it may be necessary to increase the pressure gradually until the epoxy begins to flow. It may also be necessary to wait for a few minutes for the epoxy to fill the crack and travel to the next port.
- If desired, once the injection epoxy has cured, remove the injection ports and paste-over. An epoxy-based paste-over can be removed with a chisel, scraper or grinder. The paste-over can be simply peeled off if CIP-F is used. Using a heat gun to soften the epoxy is recommended when using a chisel or scraper.
- Mixing nozzles can be used for multiple cartridges as long as the epoxy does not harden in the nozzle. For injection epoxies in side-by-side cartridges, care must be taken to ensure the level of material is the same on both parts of the cartridge. This can be done by checking for air in the cartridge and the positions of the wipers in the back of the cartridge. If the liquid levels are off by more than 1/8", then Step 1 from the injection procedures must be repeated.

Crack Injection Guide

Troubleshooting

Epoxy is flowing into the crack, but not showing up at the next port.

This can indicate that the crack either expands and/or branches off under the surface of the concrete. Continue to inject and fill these voids. In situations where the crack penetrates completely through the concrete element, and the back-side of the concrete element cannot be sealed (e.g., basement walls, or footings with backfill), longer injection time may not force the epoxy to the next port. This most likely indicates that epoxy is running out the unsealed back side of the crack. In this case, the application may require a gel viscosity injection epoxy (ETI-GV) or may not be suitable for epoxy injection repair without excavation and sealing of the back side of the crack.

Epoxy is leaking from the pasted-over crack or around injection ports.

Stop injecting. If using a fast-cure paste-over material (ETR or CIP), wipe off the leaking injection epoxy with a cotton cloth and reapply the paste-over material. Wait approximately 10–15 minutes to allow the epoxy to begin to harden. If the leak is large (e.g., the port broke off of the concrete surface), it is a good idea to wait approximately 30 minutes, or longer as necessary, to allow the paste-over to cure more completely. Check to see that the epoxy is hard before reinjecting, or the paste-over or ports may leak. Another option for small leaks is to clean off the injection epoxy and use paraffin or crayon to seal the holes.

More epoxy is being used than estimated.

This may indicate that the crack either expands or branches off below the surface. Continue to inject and fill these voids. This may also indicate that epoxy is running out the back side of the crack. If the crack penetrates completely through the concrete element and cannot be sealed, the application may require a gel viscosity injection epoxy (ETI-GV) or may not be suitable for injection repair.

Back pressure is preventing epoxy from flowing.

This can indicate several situations:

- The crack is not continuous, and the portion being injected is full.
(See above instructions about injection after the port has reached refusal.)
- The port is not aligned over the crack properly.
- The crack is blocked by debris.
- The injection epoxy used has too high a viscosity.
- If the mixing nozzle has been allowed to sit for a few minutes full of epoxy, the material may have hardened in the nozzle. Attach the E-Z-Click™ fitting to a port at another uninjected location on the crack and attempt to inject. If the epoxy still won't flow, chances are the epoxy has hardened in the nozzle. If so, replace the nozzle.

Less epoxy is being used than estimated.

This may indicate that the crack is shallower than originally thought, or the epoxy is not penetrating the crack sufficiently before moving to the next port. Reinject some ports with a lower-viscosity epoxy to see if the crack will take more epoxy. Another option is to heat the epoxy to a temperature of 80°F–100°F, which will reduce its viscosity and allow it to penetrate into small cracks easier. The epoxy should be heated uniformly; do not overheat cartridge.

Crack Injection Guide

Injection Procedure for Crack-Pac® Flex-H₂O™ Crack Sealer

1. Follow cartridge preparation instructions on the cartridge label.
Verify that the material flowing from the nozzle is a uniform green color.
2. Attach the E-Z-Click™ fitting to the end of the nozzle by pushing the tubing over the barbs at the end of the nozzle. Make sure that all ports are pushed into the open position.
3. Attach the E-Z-Click injection fitting to the first E-Z-Click port until it clicks into place. Make sure that the head of the port is pushed into the open position. In vertical applications, begin injection at the lowest port and work your way up. In a horizontal application, start at one end of the crack and work your way to the other end.
4. Inject polyurethane into the first port until material shows at the next port. Remove the E-Z-Click fitting by bracing the base of the port and pulling out gently on the head of the port to close it. Pulling too hard may dislodge the port from the surface of the concrete, causing a leak. Depress the metal tab on the head of the E-Z-Click fitting and remove it from the port.
5. Move to the next port and repeat until all ports have been injected.

Injection Tips for Crack-Pac Flex-H₂O Crack Sealer

- For narrow cracks, it may be necessary to increase the pressure gradually until the polyurethane begins to flow. It may also be necessary to wait a few minutes for the material to fill the crack and travel to the next port.
- If desired, once the polyurethane has cured, remove the injection ports and paste-over epoxy or hydraulic cement. The paste-over can be removed with a chisel, scraper or grinder.

Crack Injection Guide

Troubleshooting for Crack-Pac Flex-H₂O Crack Sealer

Polyurethane is flowing into the crack, but not showing up at the next port.

This can indicate that either the crack expands and/or branches off under the surface of the concrete. Continue to inject and fill these voids. This can indicate that the crack either expands and/or branches off under the surface of the concrete. Continue to inject and fill these voids. In situations where the crack penetrates completely through the concrete element, and the back-side of the concrete element cannot be sealed (e.g., basement walls, or footings with backfill), longer injection time may not force the epoxy to the next port. This most likely indicates that epoxy is running out the unsealed back side of the crack. In this case, the application may require a gel viscosity injection epoxy (ETI-GV) or may not be suitable for epoxy injection repair without excavation and sealing of the back side of the crack.

Back pressure is preventing polyurethane from flowing.

This can indicate several situations:

- The crack is not continuous and the portion being injected is full.
- The port is not aligned over the crack properly.
- The crack is blocked by debris.

Polyurethane is leaking from the pasted-over crack or around injection ports.

Stop injecting. If using a fast cure paste-over material (ETR or CIP), wipe off the leaking injection epoxy with a cotton cloth and reapply the paste over material. Wait a approximately 10–15 minutes to allow the paste-over to begin to harden. If the leak is large (e.g., the port broke off of the concrete surface), it is a good idea to wait approximately 30 minutes, or longer as necessary, to allow the paste-over to cure more completely. Check to see that the paste-over is hard before reinjecting or the paste-over or ports may leak.

Another option for small leaks is to clean off the injection adhesive and use paraffin or crayon to seal the holes.

More polyurethane is being used than estimated.

This may indicate that the crack either expands or branches off below the surface. Continue to inject and fill these voids.

Less polyurethane is being used than estimated.

This may indicate that the crack is shallower than originally thought, or the polyurethane is not penetrating the crack sufficiently before moving to the next port.

Crack Injection Guide

Gravity-Feed Procedure

In some horizontal applications where complete penetration isn't a requirement, cracks can be repaired using the gravity-feed method.

1. Follow cartridge preparation instructions on the cartridge label. Verify that the material flowing from the Optimix® mixing nozzle is a uniform and consistent color: For ETI-SLV, the mixed product is black, while ETI-LV is transparent amber. For Crack-Pac® injection epoxy, verify that the mixed material in the cartridge is a transparent amber color.
2. Starting at one end of the crack, slowly dispense epoxy into the crack, moving along the crack as it fills. It will probably be necessary to do multiple passes in order to fill the crack. It is possible that the epoxy will take some time to run into the crack, and the crack may appear empty several hours after the initial application. Reapply epoxy until the crack is filled.
3. In situations where the crack completely penetrates the member (e.g., concrete slab), the material may continue to run through the crack into the subgrade. It may be possible to use a small amount of coarse, dry sand to act as a barrier for the injection epoxy. Place the sand in the crack to a level no more than ¼" thickness of the member and apply the injection epoxy as described in step 2. The epoxy level will drop as it penetrates the sand, but should cure and provide a seal to the bottom of the crack. Reapply the epoxy until the crack is filled. In some cases, application of sand is impractical or not permitted and epoxy repair may not provide a complete and effective repair. Use of a gel viscosity injection epoxy (ETI-GV) may permit a surface repair to the crack with partial penetration.

Heli-Tie™ Helical Wall Tie

The Heli-Tie helical wall tie is a stainless-steel tie used to anchor building façades to structural members or to stabilize brick walls.

The helical design allows the tie to be driven quickly and easily into a predrilled pilot hole (or embedded into mortar joints in new construction) to provide a mechanical connection between a masonry façade and its backup material. As it is driven, the fins of the tie undercut the masonry to provide an expansion-free anchorage that will withstand tension and compression loads.

The Heli-Tie wall tie is installed into a predrilled hole using a proprietary setting tool with an SDS-PLUS shank rotohammer to drive and countersink the tie. Heli-Tie wall ties perform in concrete and masonry as well as wood and steel studs.



Heli-Tie Helical Wall Tie

US Patent 7,269,987

Features

- Installs quickly and easily — with the rotohammer in hammer mode, the tie installs faster than competitive products.
- Provides an inconspicuous repair that preserves the appearance of the building. After installation, the tie is countersunk up to ½" below the surface, allowing the tie location to be patched.
- Larger core diameter provides higher torsional capacity, resulting in less deflection due to “uncoiling” under load.
- Fractionally sized anchor — no metric drill bits required.
- Patented manufacturing process results in a more uniform helix along the entire tie, allowing easier driving and better interlock with the substrate.

Material: Type 304 stainless steel (Type 316 available by special order — contact Simpson Strong-Tie for details)

Test Criteria: CSA A370



Heli-Tie™ Helical Wall Tie

Installation

- Drill pilot hole through the façade material and into the backup material to the specified embedment depth + 1" using appropriate drill bit(s) in the chart below. Drill should be in rotation-only mode when drilling into soft masonry or into hollow backing material.
- Position blue end of the Heli-Tie fastener in the installation tool and insert the tie into the pilot hole.
- With the SDS-plus® rotohammer in hammer mode, drive the tie until the tip of the installation tool enters the exterior surface of the masonry and countersinks the tie below the surface. Patch the hole in the façade with a matching masonry mortar.

Heli-Tie Helical Wall Tie Product Data

Size (in.)	Model No.	Drill Bit Diameter (in.)	Quantity	
			Box	Carton
¾ x 7	HELI37700A	7/32 or ¼	50	400
¾ x 8	HELI37800A		50	400
¾ x 9	HELI37900A		50	400
¾ x 10	HELI371000A		50	200
¾ x 11	HELI371100A		50	200
¾ x 12	HELI371200A		50	200
¾ x 14	HELI371400A		50	200
¾ x 16	HELI371600A		50	200
¾ x 18	HELI371800A		50	200
¾ x 20	HELI372000A		50	200

1. Special-order lengths are also available; contact Simpson Strong-Tie for details.
2. Longer lengths up to 54" (1,370 mm) are available in a larger-diameter tie. Please note specialty drill bits are required; contact Simpson Strong Tie for details.

Heli-Tie™ Design Information

Installation Sequence

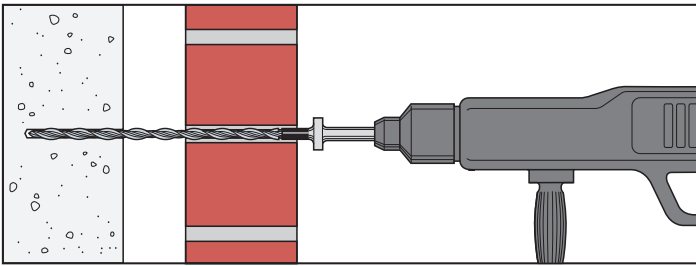
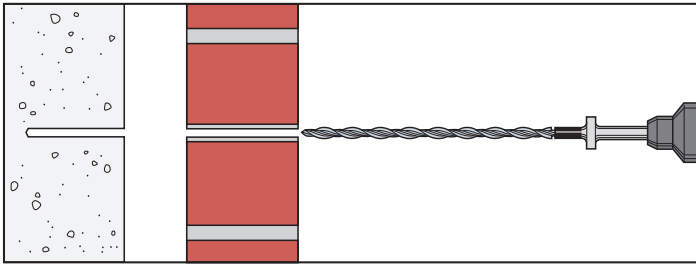
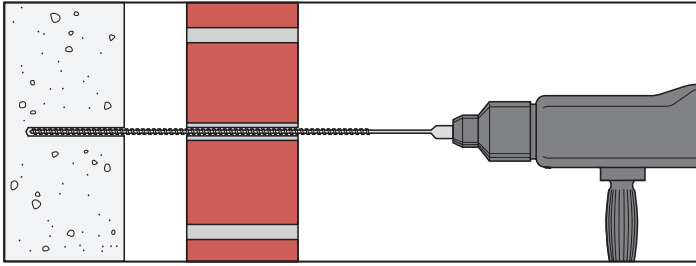

Restoration Solutions

Heli-Tie™ Accessories**Heli-Tie Fastener Installation Tool —
Model HELITool37A**

Required for correct installation of Heli-Tie wall ties. Speeds up installation and automatically countersinks the tie into the façade material.



HELITool37A

**Heli-Tie Wall Tie Tension Tester —
Model HELITEST37A**

Recommended equipment for onsite testing to accurately determine load values in any specific structure, the Heli-Tie wall tie tension tester features a key specifically designed to grip the Heli-Tie fastener and provide accurate results. Replacement test keys sold separately (Model HELIKEY37A).

Contact Simpson Strong-Tie for Heli-Tie onsite testing procedures.



HELITEST37A

HELIKEY37A

Heli-Tie™ Helical Stitching Tie

The Heli-Tie helical stitching tie provides a unique solution to the preservation and repair of damaged brick and masonry structures. Ties are grouted into existing masonry joints to repair cracks and increase strength with minimum disturbance. Made of Type 304 stainless steel, the Heli-Tie stitching tie features radial fins formed on the steel wire via cold rolling process, increasing the tensile strength of the tie.



HELIST254000

Features

- Helical design distributes loads uniformly over a large surface area
- Installs into the mortar joint to provide an inconspicuous repair and preserve the appearance of the structure
- Type 304 stainless steel offers superior corrosion resistance to mild steel reinforcement
- Batch number printed on each tie for easy identification and inspection

HELIST254000: ¼" x 40" stitching tie
(special lengths are available upon request)

Material: Type 304 stainless steel

Ordering Information: Sold in tubes of 10

Installation Instructions

- Chase bed joint 20" on either side of the affected area to a depth of approximately 1 ¼" with a rotary grinding wheel. Vertical spacing of installation sites should be 12" for red brick or "every other course" for concrete masonry units.
- Clear bed joint of all loose debris.
- Mix non-shrink repair grout or mortar per product instructions and place into the prepared bed joint, filling the void to approximately two-thirds of its depth. Simpson Strong-Tie FX-263 repair mortar should be used.
- Embed the tie at one-half the depth of the void. Trowel displaced grout to fully encapsulate the tie.
- Fill any remaining voids and vertical cracks with non-shrink repair grout or other repair mortar to conceal repair site.

Heli-Tie™ Helical Stitching Tie

Installation Sequence

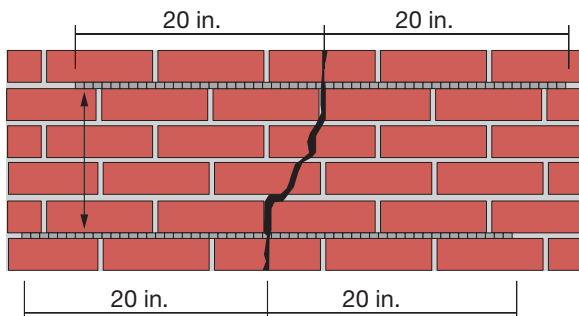
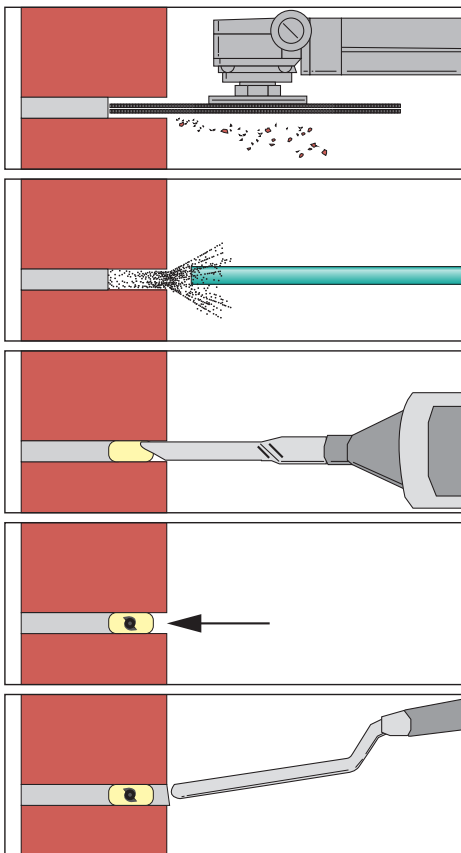

FX-70® Structural Pile Repair and Protection System

FX-70 Structural Pile Repair and Protection System for Concrete, Timber and Steel Structures

The FX-70 system features custom-made tongue-and-groove seamed fiberglass jackets that provide a corrosion-resistant protective shell for the life of the repair. High-strength repair grouts are used to strengthen and protect damaged piles. These products displace existing water and can be easily pumped or poured into the FX-70 jacket even while it is submerged in water.

FX-70 System Advantages

- Economically repair damage to concrete, timber and steel pilings without taking the structure out of service
- No need for cofferdams or dewatering
- No need for heavy lifting equipment
- Resists corrosion, deterioration, weathering and abrasion to protect and prevent deterioration of steel, concrete and timber pilings
- Low-impact installation in marine environments
- Easily blends with existing structure
- Economically repair damage to piles without taking the structure out of service
- Protect or prevent further deterioration of pilings instead of replacing them

To learn more, visit strongtie.com/fx70 or call (800) 999-5099.

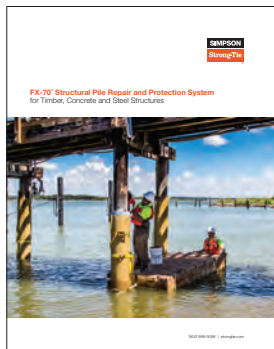

Flier F-R-FX70



Watch How to Install FX-70 Jackets in Water at strongtie.com/videolibrary.

For additional materials needed to complete your concrete repair projects, please visit our website strongtie.com for further information on our epoxies, coatings and mortars.

FX-70® Structural Pile Repair and Protection System

The FX-70 structural pile repair and protection system is customized to the exact specifications of each job, manufactured in the U.S.A., and shipped directly to your job site. The FX-70 tongue-and-groove seamed jacket provides a corrosion-resistant shell with over 40 years of demonstrated in-service performance.

Components

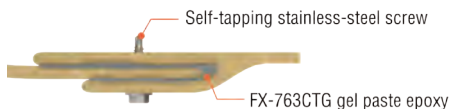

Cross-Section of Tongue-and-Groove Joint

Epoxy Grout Method

Typically for piles with less than 25% section loss, the jacket is sized for a ½" (13 mm) annulus, and then completely filled with FX-70-6MP™ multi-purpose marine epoxy grout.

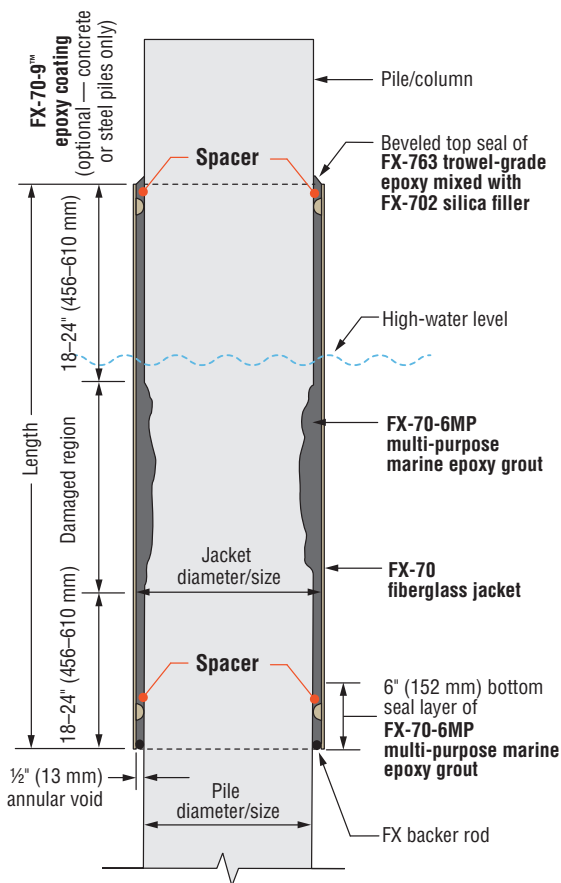

- FX-70-6MP multi-purpose marine epoxy grout used for bottom seal and repair
- Typical annular void of ½" (13 mm)
- ¾" (19 mm) annular void for H-piles

FX-70® Structural Pile Repair and Protection System

Combination Method

Typically for piles with greater than 25% section loss, the jacket is sized for a 2" (51 mm) annulus, and then filled with a combination of FX-70-6MP multi-purpose marine epoxy grout and FX-225 non-shrink underwater grout.

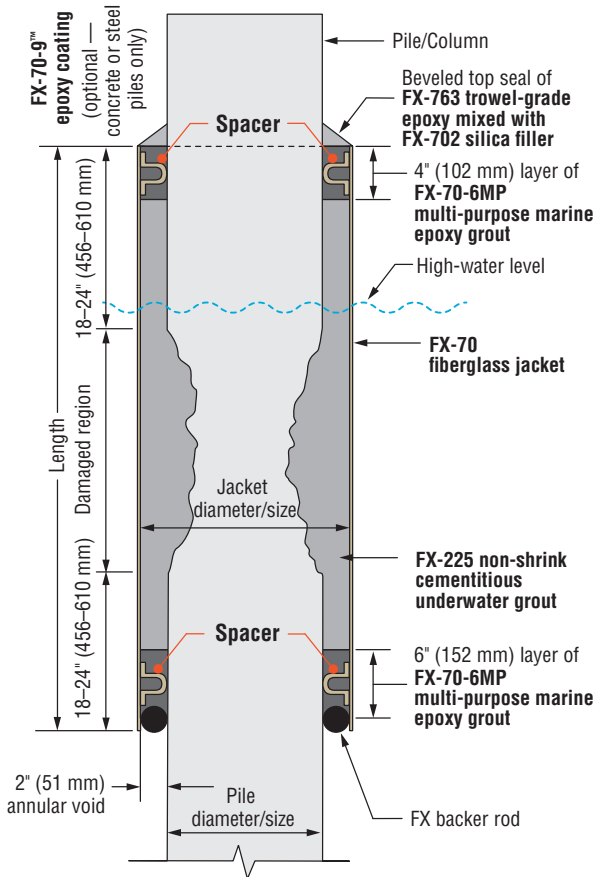

- **FX-70-6MP multi-purpose marine epoxy grout** used for top and bottom seal
- **FX 225 non-shrink underwater grout** used for repair
- Typical annular void of 2" (51 mm)

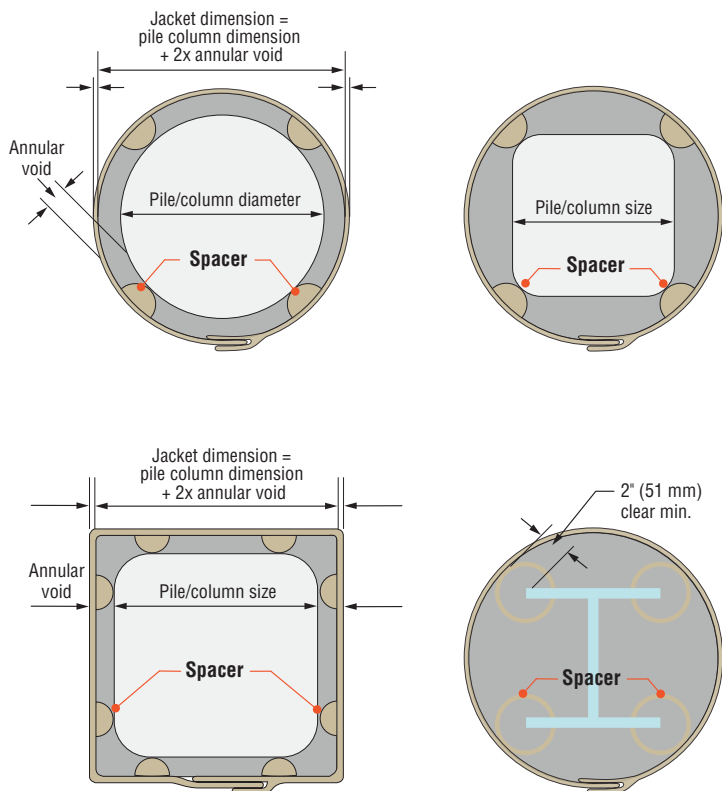

CSS Composite Strengthening Systems™

Your Full-Solution Partner for Composite Strengthening Systems

Composite Strengthening Systems (CSS) provide efficient solutions for the structural reinforcement and retrofit of aging, damaged or overloaded concrete, masonry, steel and timber structures.

The primary benefit of Composite Strengthening Systems versus traditional retrofit methods is that significant flexural, axial or shear strength gains can be realized with an easy-to-apply composite that does not add significant weight or mass to the structure.

CSS Advantages

- No-cost in-house engineering and technical support
- Economically increase capacity without significantly increasing weight or mass
- Extremely high tensile strength
- Very lightweight and user-friendly installation
- Non-corrosive
- Low aesthetic impact
- Compatible with many finishes and protective coatings

For complete information regarding specific products suitable to your unique situation or condition, please visit strongtie.com/css or call your local RPS specialist at (800) 999-5099.



Flier F-R-CSS

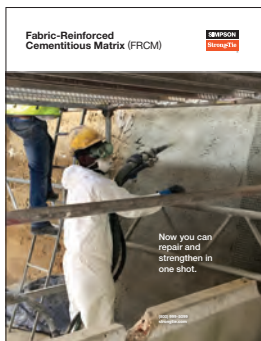

Flier F-R-FRCM

CSS Composite Strengthening Systems™

CSS Solutions

CSS enhances the structural capacity of existing structural elements which require additional strengthening, rehabilitation and repair in such applications as seismic retrofit, structural preservation, force protection, blast mitigation, and corrosion-related repair and rehabilitation. CSS effectively increases capacity where adding weight or mass through traditional strengthening methods is not feasible.

System Solutions for Reinforcement

Type	Slab	Beam	Wall	Column/Pile
Externally Applied Laminates	Flexural/Collector	Flexural/Collector	Tensile/Flexural	Flexural
Near-Surface Mounted Laminates	Flexural/Collector	Flexural/Collector	Tensile/Flexural	Flexural
Fabrics	Flexural/Collector	Shear/Flexural/Collector	Shear/Flexural/Tensile	Shear/Flexural/Confinement
FRCM	Flexural/Collector	Shear/Flexural/Collector	Shear/Flexural/Tensile	Shear/Flexural/Confinement



- 1. Slab** — Adds collector reinforcement, negative (not shown) and positive moment flexural capacity
- 2. Slab opening** — Trim reinforcement
- 3. Beam** — Laminates, FRCM or fabrics for flexure and/or collector reinforcement, fabrics or FRCM for shear stirrup reinforcement and potential use of FRP anchors (shown in orange)
- 4. Wall** — Stiffening, flexural, shear or tensile reinforcement with FRCM, fabrics and/or laminates
- 5. New wall opening** — Trim reinforcement
- 6. Column wrapping** — Full column wrap to achieve required strengthening, possibly with additional near-surface mounted laminates, FRCM or fabric for flexure; effective solution for under-reinforced column ties
- 7. Protective coating** — High-performance protection against exposure, corrosion, chemical attack, abrasion, fire resistance and other environmental factors

CSS Composite Strengthening Systems™

Components

Fabric

Several types of code-listed and non-code-listed FRP fabrics including carbon fiber and E-glass are available to meet specifier and contractor requirements. Field lamination provides flexibility and short installation time, resulting in lower labor costs and less downtime than are usual with traditional retrofit methods.

- Conforms to any shape
- Can be cut/field-adjusted to address odd shapes/orientations
- May be placed in multiple layers for increased capacity gain
- Variety of tow orientation/composition allows for design flexibility

Carbon Fiber Fabrics

CSS-CUCF11	Code-Listed Unidirectional Carbon Fabric — 11 oz./yd. ² (370 g/m ²)
CSS-CUCF22	Code-Listed Unidirectional Carbon Fabric — 22 oz./yd. ² (740 g/m ²)
CSS-CUCF44	Code-Listed Unidirectional Carbon Fabric — 44 oz./yd. ² (1,490 g/m ²)
CSS-UCF10	Unidirectional Carbon Fabric — 10 oz./yd. ² (340 g/m ²)
CSS-UCF20	Unidirectional Carbon Fabric — 20 oz./yd. ² (680 g/m ²)
CSS-BCF06	Bidirectional Carbon Fabric (0/90°) — 6 oz./yd. ² (204 g/m ²)
CSS-BCF018	Bidirectional Carbon Fabric (0/90°) — 18 oz./yd. ² (611 g/m ²)
CSS-BCF418	Bidirectional Carbon Fabric (+/- 45°) — 18 oz./yd. ² (611 g/m ²)

E-Glass Fiber Fabrics

CSS-CBGF424	Code-Listed Bidirectional E-Glass Fabric (+/- 45) — 24 oz./yd. ² (814 g/m ²)
CSS-BGF012	Bidirectional E-Glass Fabric (0/90°) — 12 oz./yd. ² (407 g/m ²)
CSS-BGF018	Bidirectional E-Glass Fabric (0/90°) — 18 oz./yd. ² (611 g/m ²)
CSS-CUGF27	Code-Listed Unidirectional E-Glass Fabric 27 oz./yd. ² (915 g/m ²)



Unidirectional Carbon Fabric



Unidirectional E-Glass Fabric

CSS Composite Strengthening Systems™

Components (cont.)

Carbon and E-Glass Anchors

High-strength FRP anchors are field laminated and used to carry load into the concrete to effectively improve bond strength, or through the concrete to transfer load for increased capacity. Termination and through anchors in carbon and E-glass fiber are available in diameters from ¼" (6.4 mm) to 1½" (38.1 mm) in commonly used stock and custom lengths.

CSS-CA	Carbon Fiber Anchor
CSS-GA	E-Glass Fiber Anchor

Epoxies

CSS-ES-3KT	Epoxy Primer and Saturant — 3 US gallon (11.4 L)
CSS-ES-150KT	Epoxy Primer and Saturant — 150 US gallon (567.8 L)
CSS-EP-3KT	Epoxy Paste and Filler — 3 US gallon (11.4 L)
CSS-UES-3KT	Underwater Epoxy Saturant — 3 US gallon (11.4 L)

Protective Coatings

FX505XXXX-5	FX-505 Water-Based Acrylic Coating — 5 US gallon (18.9 L)
FX70-9XKT3	FX-70-9™ Epoxy Coating — 3 US gallon (11.4 L) kit
FX70-9XKT15	FX-70-9 Epoxy Coating — 15 US gallon (56.8 L) kit
FX207KT1-1	FX-207 Slurry Seal — 3.3 US gallon (12.5 L) kit

Fire Insulation

FX-207 Slurry Seal may be applied over CSS FRP materials for fire insulation and flame-spread/smoke-developed coating providing a 4-hour rated system per ASTM E119 and UL 263 and a Class A finish for ASTM E84 flame-spread and smoke-developed classification.



Carbon Termination Anchor



FX-70-9 Epoxy Coating applied over Carbon Fiber Fabric

CSS Composite Strengthening Systems™

Components (cont.)

Precured Carbon-Fiber Laminate

CSS-CUCL is an epoxy-based, pultruded, unidirectional, high-strength, non-corrosive carbon-fiber-reinforced polymer (CFRP) precured laminate for both surface mounted and near surface mounted (NSM) structural reinforcement applications.

- No field saturation required
- Highest tensile capacity available
- Lower overall installed cost/labor savings
- Available in a variety of widths and thicknesses and may be cut to length

CSS-CUCL

Code-Listed Unidirectional Carbon Laminate



For additional materials needed to complete your concrete repair projects, please visit our website strongtie.com for further information on our epoxies, coatings and mortars.

CSS Composite Strengthening Systems™

Components (cont.)

Fabric-Reinforced Cementitious Matrix (FRCM)

Repair, protect and strengthen aging, damaged or overloaded concrete and masonry structures in one application and significantly reduce your installed cost. FRCM, or fabric-reinforced cementitious matrix, combines high-performance sprayable mortar with carbon-fiber grid to create thin-walled, reinforced concrete shells without adding significant weight or mass to the structure.

Benefits

- Repair and strengthen structures using only a thin layer of material
- Can be applied in multiple grid layers (four maximum) to achieve desired strengthening
- Lightweight system for vertical surfaces and overhead applications
- Suitable for harsh environments or service conditions including marine locations, elevated temperatures, humidity, abrasion and UV
- Works on damp substrates
- Installation process is similar to that for wet shotcrete repair mortars
- Quick installation with less preparation than traditional shotcrete repairs with rebar
- Does not create a vapor barrier
- Matches substrate finish

CSS-CM	Cementitious Matrix — 55 lb. (24.9 kg) bag
CSS-BCG19550	Bidirectional Carbon Grid
CSS-HBCG19550	Heavy Bidirectional Carbon Grid
CSS-UCG19550	Unidirectional Carbon Grid



Fabric-Reinforced Cementitious Matrix (FRCM)



Carbide Drill Bits



Drill Bit Matrix

Shank Types



SDS-max®



SDS-plus®



Spline



Straight



Spline

(design disables rotohammer rotation)



3/4" Hex

Drill Bits



Solid-Tip Carbide Drill Bit



Quad Head



Standard Two-Cutter Head

Rebar Cutters



Rebar Cutter Detail

Demolition Chisels



Scraper



Flat Chisel



Bull-Point Chisel



Asphalt Cutter



Bushing Tool Head



Ground Rod Driver



Scaler

Core Bits



Carbide Drill Bits for Concrete and Masonry

Carbide Drill Bit Selection Information

Our carbide-tipped drill bits are premium-quality, professional-grade tools manufactured in Germany to the highest industry standards for Simpson Strong-Tie.

They are designed to meet precise ANSI tolerance requirements and incorporate proprietary features that enhance durability and drilling speed, while improving ease of use. Regular and quad-head bit tip and solid-tipped configurations are available. Shank styles include SDS-plus®, SDS-max®, spline and straight.

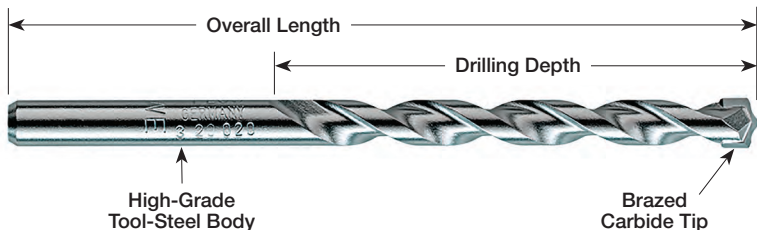

Features and Benefits

- Uniformly brazed carbide inserts result in longer bit life
- Most bits contain a centering tip that facilitates easy spot drilling
- Chromium-nickel-molybdenum steel alloy body ensures hammering quality and extended service life
- Heat-treatment procedures and shot-peened finish increase surface hardness and drilling speed, reduce drill bit wear and improve resistance to bending forces
- Drill bits conform to ANSI Standard B212.15

Additional Features for SDS-max, Spline and Select SDS-plus Bits:

- Chisel-shaped drill bit head penetrates the material and directs concrete dust into the multi-flute spiral
- Patented, high-volume, multi-flute spiral quickly channels concrete dust from the hole to improve drilling speed
- 4 x 90° head geometry crushes through rebar and prevents sticking in reinforced concrete



Solid-Tip Carbide Drill Bit

Carbide Drill Bits for Concrete and Masonry

Quad-Head Feature

(Available in SDS-plus®, SDS-max® and spline shank)

All the features of single cutter bits and the quad-head dual-cutter are designed to improve durability and drilling speed. The high-volume, double-helix design of the quad-head bit comes with the patented, high-performance, reinforced core flute to maximize energy transfer.

Simpson Strong-Tie® drill bits come in various shank styles to fit virtually any drill or rotohammer.



SDS-max



SDS-plus



Spline



Straight

SDS-plus® Drill Bits

SDS-plus Shank Bits

Diameter (in.)	Drilling Depth (in.)	Overall Length (in.)	Model No.
5/32	2	4 1/4	MDPL01504
	4	6 1/4	MDPL01506
3/16	4	6 1/4	MDPL01806
	6	8 1/4	MDPL01808
	8	10	MDPL01810
	10	12	MDPL01812
	12	14	MDPL01814
7/32	4	6 1/4	MDPL02106
	6	8 1/4	MDPL02108
	8 1/4	11	MDPL02111
	14	16	MDPL02116
1/4	2	4 1/4	MDPL02504
	4	6 1/4	MDPL02506
	6	8 1/4	MDPL02508
	9	11	MDPL02511
	12	14	MDPL02514
	14	16	MDPL02516
5/16	4	6 1/4	MDPL03106
	10	12	MDPL03112
3/8	4	6 1/4	MDPL03706
	8	10 1/4	MDPL03710
	10	12 1/4	MDPL03712
	16	18	MDPL03718
	22	24	MDPL03724
7/16	4	6 1/4	MDPL04306
	10	12 1/4	MDPL04312
1/2	4	6 1/4	MDPL05006
	8	10 1/4	MDPL05010
	10	12 1/4	MDPL05012
	16	18	MDPL05018
	22	24	MDPL05024
9/16	4	6 1/4	MDPL05606
	10	12 1/4	MDPL05612
	16	18	MDPL05618
5/8	6	8	MDPL06208
	10	12	MDPL06212
	16	18	MDPL06218
	22	24	MDPL06224
1 1/16	6	8	MDPL06808
3/4	6	8	MDPL07508
	8	10	MDPL07510
	10	12	MDPL07512
	16	18	MDPL07518
	22	24	MDPL07524
7/8	6	8	MDPL08708
	10	12 1/4	MDPL08712
	16	18	MDPL08718
1	8	10	MDPL10010
	16	18	MDPL10018

SDS-plus Shank Bit

SDS-plus bits use an asymmetrical-parabolic flute for efficient energy transmission and dust removal.



SDS-plus® Drill Bits

SDS-plus Solid-Tip Carbide Drill Bits

Diameter (in.)	Total Length (in.)	Drilling Depth (in.)	Model No.
3/16	6 1/4	4	MDPL01806S
1/4	6 1/4	4	MDPL02506S
1/4	12	10	MDPL02512S
3/8	6 1/4	4	MDPL03706S
3/8	12 1/4	10	MDPL03712S
1/2	6 1/4	4	MDPL05006S
1/2	12 1/4	10	MDPL05012S
9/16	6	4	MDPL05606S
9/16	12	10	MDPL05612S



Solid-Tip Carbide Drill Bit

SDS-plus Quad Head Drill Bits

Diameter (in.)	Drilling Depth (in.)	Overall Length (in.)	Model No.
5/8	6	8	MDPL06208Q
	10	12	MDPL06212Q
	16	18	MDPL06218Q
3/4	6	8	MDPL07508Q
	10	12	MDPL07512Q
	16	18	MDPL07518Q
7/8	6	8	MDPL08708Q
	10	12	MDPL08712Q
	16	18	MDPL08718Q
1	8	10	MDPL10010Q
	16	18	MDPL10018Q
1 1/8	8	10	MDPL11210Q
	16	18	MDPL11218Q
1 1/4	16	18	MDPL12518Q



Quad Head

SDS-plus® Drill Bits

SDS-plus Shank Bits — Retail Packs

Diameter (in.)	Drilling Depth (in.)	Overall Length (in.)	Quantity (per pack)	Model No.
5/32	4	6 1/4	25	MDPL01506-R25
3/16	2	4 1/4	25	MDPL01804-R25
	4	6 1/4	25	MDPL01806-R25
	6	8 1/4	25	MDPL01808-R25
	8	10	25	MDPL01810-R25
	10	12	25	MDPL01812-R25
	12	14	25	MDPL01814-R25
7/32	4	6 1/4	25	MDPL02106-R25
	6	8 1/4	25	MDPL02108-R25
	8 3/4	11	25	MDPL02111-R25
1/4	2	4 1/4	25	MDPL02504-R25
	4	6 1/4	25	MDPL02506-R25
	6	8 1/4	25	MDPL02508-R25
	8 3/4	11	25	MDPL02511-R25
5/16	4	6 1/4	25	MDPL03106-R25
3/8	4	6 1/4	25	MDPL03706-R25
	10	12 1/4	25	MDPL03712-R25
1/2	4	6 1/4	25	MDPL05006-R25
	10	12 1/4	25	MDPL05012-R25
5/8	6	8	20	MDPL06208-R20



SDS-plus Retail Packs



Fixed-Depth Drill Bit

Fixed-Depth Drill Bits

Model No.	Drill Bit Diameter (in.)	Drill Depth (in.)	Drop-In Anchor (in.)
Standard Drop-In Anchors (DIAB, DIA)			
MDPL037DIA	3/8	1 1/16	1/4
MDPL050DIA	1/2	1 11/16	3/8
MDPL062DIA	5/8	2 1/16	1/2
Short Drop-In Anchors (DIAS)			
MDPL050DIAS	1/2	1 11/16	3/8
MDPL062DIAS	5/8	2 1/16	1/2

SDS-plus® Drill Bits

Titen® Screw Drill Bit/Driver Product Data*

Diameter (in.)	Drilling Depth (in.)	Overall Length (in.)	For Screw Diameter (in.)	Model No.
5/32	3 1/8	6	3/16	MDPL01506H
	4 1/8	7	3/16	MDPL01507H
3/16	2 3/8	5	1/4	MDPL01805H
	3 1/8	6	1/4	MDPL01806H
	4 1/8	7	1/4	MDPL01807H

Product is sold individually.

Titen® Screw Drill Bit/Driver — Bulk Packs*

Diameter (in.)	Drilling Depth (in.)	Overall Length (in.)	For Screw Diameter (in.)	Model No.
5/32	4 1/8	7	3/16	MDPL01507H-R25
3/16	4 1/8	7	1/4	MDPL01807H-R25

*SDS-plus shank.

Special hex adapter (included with the Titen® screw installation kit — TTN2INSTALLKIT) allows the Titen installation tool to slide over the bit and lock in, ready to drive Titen concrete and masonry screws. Rotohammer must be in rotation-only mode before driving screws.



SDS-plus® and SDS-max® Drill Bits

SDS-plus and SDS-max Quad Head Shank Bits

Diameter (in.)	Drilling Depth (in.)	Overall Length (in.)	Model No.
3/8	7 1/2	13	MDMX03713
1/2	7 1/2	13	MDMX05013
	15 1/2	21	MDMX05021
9/16	7 1/2	13	MDMX05613
	15 1/2	21	MDMX05621
5/8	7 1/2	13	MDMX06213Q
	15 1/2	21	MDMX06221Q
	30 1/2	36	MDMX06236Q
1 1/16	15 1/2	21	MDMX06821Q
3/4	8	13	MDMX07513Q
	17	21	MDMX07521Q
	31	36	MDMX07536Q
1 3/16	17	21	MDMX08121Q
7/8	8	13	MDMX08713Q
	17	21	MDMX08721Q
1	8	13	MDMX10013Q
	17	21	MDMX10021Q
	31	36	MDMX10036Q
1 1/16	18	23	MDMX10623Q
1 1/8	12	17	MDMX11217Q
	17	21	MDMX11221Q
	31	36	MDMX11236Q
1 3/16	18	23	MDMX11823Q
1 1/4	10	15	MDMX12515Q
	18	23	MDMX12523Q
	31	36	MDMX12536Q
1 5/8	12	17	MDMX13717Q
	18	23	MDMX13723Q
1 1/2	18	23	MDMX15023Q
1 3/4	18	23	MDMX17523Q
2	18	23	MDMX20023Q

Model numbers ending with "Q" denote Quad Head.



SDS-max
Shank Bit



Quad Head

Model numbers ending with "Q" denote quad-head bits.

Spline Shank Drill Bits

Spline Shank Bits

Diameter (in.)	Drilling Depth (in.)	Overall Length (in.)	Model No.
3/8	8	13	MDSP03713
	11	16	MDSP03716
7/16	8	13	MDSP04313
1/2	8	13	MDSP05013
	11	16	MDSP05016
	17	22	MDSP05022
	31	36	MDSP05036
9/16	8	13	MDSP05613
	18	23	MDSP05623
5/8	8	13	MDSP06213
	11	16	MDSP06216
	17	22	MDSP06222
	31	36	MDSP06236
1 1/16	11	16	MDSP06816
3/4	8	13	MDSP07513
	11	16	MDSP07516
	17	22	MDSP07522
	31	36	MDSP07536
7/8	11	16	MDSP08716
	17	22	MDSP08722
	31	36	MDSP08736
1	11	16	MDSP10016
	17	22	MDSP10022
	31	36	MDSP10036
1 1/8	17	22	MDSP11222
1 1/4	17	22	MDSP12522
1 3/8	17	22	MDSP13722
1 1/2	17	22	MDSP15022
1 3/4	17	22	MDSP17522
2	17	22	MDSP20022

Spline shank bits continued on the next page.



Spline Shank Bit

Splined Shank Drill Bits

Splined Shank Quad Head Bits

Diameter (in.)	Drilling Depth (in.)	Overall Length (in.)	Model No.
5/8	11	16	MDSP06216Q
	17	22	MDSP06222Q
	31	36	MDSP06236Q
3/4	11	16	MDSP07516Q
	17	22	MDSP07522Q
	31	36	MDSP07536Q
7/8	11	16	MDSP08716Q
	17	22	MDSP08722Q
1	17	22	MDSP10022Q
	31	36	MDSP10036Q
1 1/8	11	16	MDSP11216Q
	17	22	MDSP11222Q
1 1/4	17	22	MDSP12522Q
	31	36	MDSP12536Q
1 3/8	17	22	MDSP13722Q
1 1/2	17	22	MDSP15022Q



Quad Head



Splined Shank Bit

Carbide Drill Bits

Straight Shank Drill Bits

Straight Shank Bits

Diameter (in.)	Drilling Depth (in.)	Overall Length (in.)	Model No.
1/8	1 3/8	3	MDB01203
3/16	4	6	MDB01806
1/4	2 1/8	4	MDB02504
	4	6	MDB02506
	10	12	MDB02512
5/16	4	6	MDB03106
3/8	4	6	MDB03706
	10	12	MDB03712
7/16	4	6	MDB04306
1/2	4	6	MDB05006
	10	12	MDB05012
5/8	3 1/2	6	MDB06206
3/4	4	6	MDB07506



Straight Shank Bit

Straight Shank Bits – Retail Packs

Diameter (in.)	Drilling Depth (in.)	Overall Length (in.)	Quantity (per pack)	Model No.
3/16	4	6	25	MDB01806-R25
1/4	2 1/8	4	25	MDB02504-R25
	4	6	25	MDB02506-R25
5/16	4	6	25	MDB03106-R25
3/8	4	6	25	MDB03706-R25
1/2	4	6	25	MDB05006-R25



Rebar Cutters

Rebar Cutters*

When hole placement conflicts with rebar or wire mesh, these bits enable the rebar to be removed so the hole can be drilled to the proper depth. Rebar cutters are separate from shanks. Shanks work with all sizes of rebar cutters. Overall length is approximately 15".

* After drilling through the reinforcement or plate, remove debris from the hole and resume drilling with carbide-tipped drill bit.



Rebar Cutter Detail



Rebar Cutter

Diameter (in.)	Drilling Depth (in.)	Model No.
1/2	12	MCR05012
5/8	12	MCR06212
3/4	12	MCR07512
7/8	12	MCR08712
1	12	MCR10012

Shanks for Rebar Cutters

Shank Style	Model No.	Description
Straight	MC	For use in drills with jawed chucks. Use in rotation-mode only.
SDS-plus®	MCSDP	For use in SDS-plus style drills. Use in rotation-mode only.
SDS-max®	MCSDM	For use in SDS-max style drills. Shank design allows rotation only.
Spline	MCS	For use in spline-style drills. Shank design allows rotation only.



SDS-plus Shank



Spline Shank

Rebar Adapters

Drill Bit Shank Adapters

Description (shank style to bit type)	Model No.
SDS-max® to SDS-plus® Adapter	ADMX2PL
Spline to SDS-plus Adapter	ADSP2PL



SDS-max to SDS-plus Adapter



Spline to SDS-plus Adapter

Demolition Chisels and Bits

Simpson Strong-Tie® chisels are made of toughened steel with special surface treatment that improves performance. The superior tempering process creates a hardened surface that is more wear-resistant and allows the working point to be re-sharpened, which extends the life of the tool.

Simpson Strong-Tie demolition chisels and bits come in various shank styles to fit virtually any demolition tool.



SDS-max®



SDS-plus®



Spline
*(design disables
rotohammer rotation)*

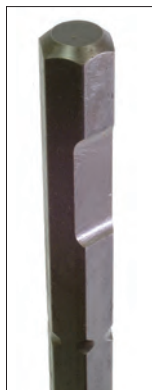

¾" Hex

Scrapers

Removing Tiles, Flooring and Other Materials

Shank Type	Head Width (in.)	Overall Length (in.)	Model No.
SDS-plus	¾	10	CHPLF07510
	1½	10	CHPLSC15010
SDS-max	2	12	CHMXSCP20012
Spline	2	12	CHSPSCP20012



Scraper

Demolition Chisels and Bits

Flat Chisels

General Concrete and Masonry Demolition

Shank Type	Head Width (in.)	Overall Length (in.)	Model No.
SDS-max®	1	12	CHMXF10012
	1	18	CHMXF10018
Spline	1	12	CHSPF10012
	1	18	CHSPF10018



Flat Chisel

Bull Point Chisels

General Concrete and Masonry Demolition

Shank Type	Overall Length (in.)	Model No.
SDS-plus®	10	CHPLBP10
SDS-max	12	CHMXBP12
	18	CHMXBP18
Spline	12	CHSPBP12
	18	CHSPBP18



Bull-Point Chisel

Asphalt Cutters

Asphalt, Hardpan and Compacted Soil Cutting

Shank Type	Head Width (in.)	Overall Length (in.)	Model No.
SDS-max	3½	16	CHMXAC35016
¾" Hex	3½	16	CHHAC35016



Asphalt Cutter

Demolition Bits

Scalers

Removing Large Quantities of Material

Shank Type	Head Width (in.)	Overall Length (in.)	Model No.
SDS-max®	1½	12	CHMXSC15012
	2	12	CHMXSC20012
	3	12	CHMXSC30012
Spline	2	12	CHSPSC20012
	3	12	CHSPSC30012



Scaler

Ground Rod Drivers

Driving in Ground Rods

Shank Type	Head Width (in.)	Overall Length (in.)	Model No.
SDS-max	7/8	10¼	CHMXRD08710
Spline	7/8	10¼	CHSPRD08710



Ground Rod Driver

Bushing Tools One Piece

Concrete and Asphalt Surface Roughening

Shank Type	Head Width (in.)	Overall Length (in.)	Model No.
SDS-max	1¾	9½	CHMXBT17509
Spline	1¾	9¼	CHSPBT17509



Bushing Tool Head

Core Bits

Core Bits

Simpson Strong-Tie® core bits are made to the same exacting standards as our standard carbide-tipped drill bits. They utilize a centering bit to facilitate accurate drilling in combination hammer/drill mode.

Core Bits with Centering Bit — SDS-max® Shank

Diameter (in.)	Drilling Depth (in.)	Overall Length (in.)	Model No.
2	6¼	22	CBMX20022
2½	6¼	22	CBMX26222
3½	6¼	22	CBMX31222
3½	6¼	22	CBMX35022
4	6¼	22	CBMX40022
5	6¼	22	CBMX50022

Note: With 1-piece bits, once coring is begun, the centering bit must be removed using ejector pin. Core bit bodies are 2¼" deep.



Core Bit
Transfers Energy
Efficiently

Core Bits

Core Bit Replacement Parts

Core Bit Center Pilot Bit

Diameter (in.)	Overall Length (in.)	Model No.
7/16	4 3/4	CTRBTF04304

Ejector Key

Diameter (in.)	Model No.
3/8	CDBEJKEY



Ejector Key

Core Bit
Center
Pilot Bit

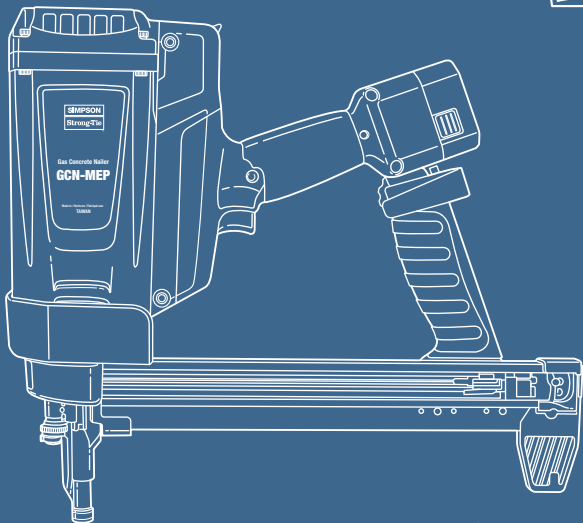
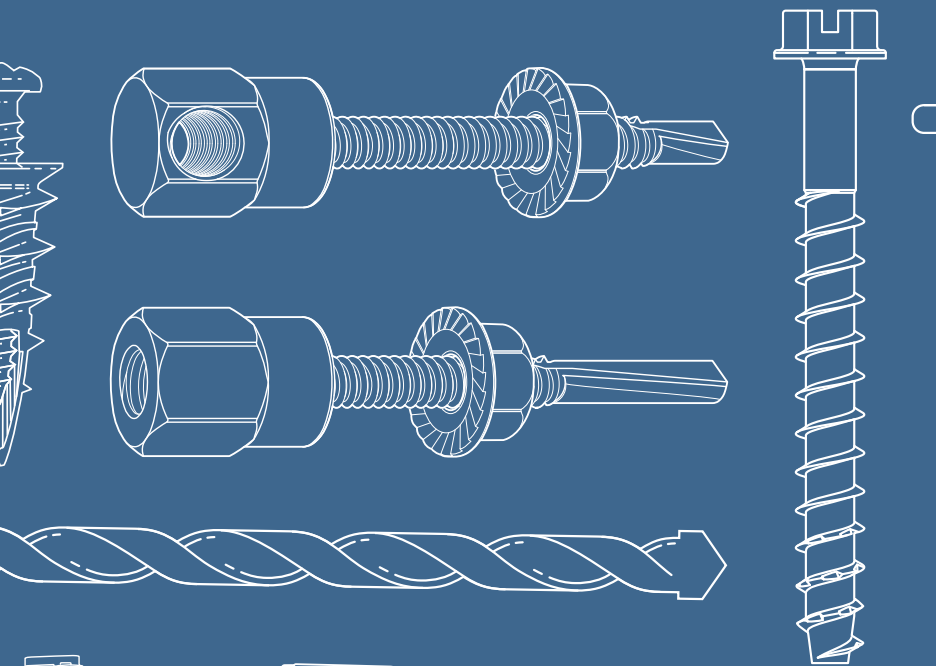

Appendix

Market Segments and Applications

	Anchor Products for Corrosive Environments	pp. 198–203
	Light-Frame Construction	pp. 204–205
	Retrofit and Repair	pp. 206–207
	Crack Injection	pp. 208–209
	Wastewater / Water Treatment	pp. 210–211
	Bridge and Marine	pp. 212–213
	Manufacturing, Maintenance and Material Handling (OEM)	pp. 214–215
	Composite Strengthening Systems™	pp. 216–217
	Cold-Formed Steel Construction	pp. 218–219

Anchor Products for Corrosive Environments

Trusted quality, code approved and innovative stainless-steel anchors that can be installed in exterior and corrosive environments.

When it comes to anchorage, specifying a material that can withstand the environment is critical. Proper protection comes from materials that are capable of resisting corrosion while maintaining their strength.

Most anchor products are made from carbon steel. This material is easy to form into a screw or an expansion anchor and can be heat treated to increase its strength and durability. Steel is versatile but can weaken in a corrosive environment. Left unprotected, the iron in the steel will react with oxygen and moisture to form iron oxide — also known as rust.

Environments

There are four levels of corrosive environments (as shown below).

Minimum Corrosion Resistance Recommendations

Corrosion Resistance Classification by Environment	Recommended Product Material or Coating
Low	Zinc plated
Medium	Mechanically galvanized (ASTM B695 — Class 55)
	Hot-dip galvanized (ASTM A153 — Class C)
High	Type 302, 303 or 304 stainless steel
Severe	Type 316 stainless steel

Anchor Products for Corrosive Environments**Quick Guide to Choosing the Right Stainless-Steel Grade****High**

A highly corrosive environment is a location where anchors are exposed to chemicals such as fertilizers, soil, acid rain and other corrosive elements. Examples of these environments include kitchens, industrial zones, food-processing facilities, wineries, breweries, outdoor facilities and severe exterior conditions.



Typical high-corrosive environment — central utility plants.



Typical high-corrosive environment — food-processing plants.

Medium

A medium-level corrosive environment is typically a general exterior location where chlorides or corrosive chemical elements are not present. Examples of elements at risk to medium-exposure corrosion are stadium seating, exterior handrails, exterior facade anchorages and other components of outdoor facilities.



Typical medium exposure — outdoor seating.



Typical medium-corrosive environment — exterior anchorage.

Low

Finally, low-corrosive environments consist of interior dry spaces. Examples of such applications are warehouse racking, machinery installations, facility catwalk anchorage, interior furniture anchorages and so forth.



Typical low-corrosive environment — interior warehouse.

Anchor Products for Corrosive Environments

Type 304 stainless steel and Type 316 stainless steel products for your job.

Anchor — Stainless-Steel Products	Type 304	Type 316	Type 410
Drop-In (DIA) internally threaded anchor	✓	✓	
Sleeve-All® sleeve anchor	✓		
Stainless-steel Titen HD® heavy-duty screw anchor	✓	✓	
Strong-Bolt® 2 wedge anchor	✓	✓	
Titen® stainless-steel concrete and masonry screw			✓
Wedge-All® wedge anchor	✓	✓	
Zinc Nailon™ pin drive anchor	✓		



**Stainless-Steel
Titen HD**
Heavy-Duty Screw
Anchor

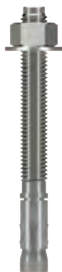

Strong-Bolt 2
Wedge Anchor



Wedge-All
Wedge Anchor



Sleeve-All
Sleeve Anchor



Drop-In (DIA)
Internally
Threaded Anchor



**Stainless-Steel
Titen**
Concrete and
Masonry Screw



Zinc Nailon
Pin Drive
Anchor

Anchor Products for Corrosive Environments

Concrete Adhesives for Stainless-Steel Threaded Rod

**SET-3G™****High-Strength Epoxy Adhesive**

- Install in dry, water-saturated or water-filled holes in base materials with temperatures between 40°F and 100°F
- NSF/ANSI standard 61 approved

**SET-XP®****High-Strength Epoxy Adhesive**

- AC308 qualified for rebar doweling to achieve rebar yield, development length and lap splices
- NSF/ANSI standard 61 approved

**AT-XP®****High-Strength, Fast-Cure,
All-Weather Acrylic Adhesive**

- Can be used in cold temperatures as low as 14°F
- NSF/ANSI standard 61 approved

Anchor Products for Corrosive Environments

When designing strong and durable anchorage solutions for corrosive environments, the two most commonly considered materials are Types 304 and 316 stainless steel.

Type 300 Series stainless-steel screw anchors have different corrosion-resistant properties for different environments. When matched to the appropriate environment and application, anchors made from Type 300 Series stainless steel will resist the effects of corrosion and maintain their strength and integrity. Type 316 is the optimal choice for applications in corrosive or extreme environments such as salt water, or when chemical or corrosive solutions are present. Type 304 is a cost-effective solution for less extreme applications where the environment may be wet, moist or damp.

For using in seating, catwalks, machinery, piping, railings and more.

Type 316 Stainless Steel

- Wastewater treatment
- Fertilizer storage buildings
- Sill plates in coastal environments
- Marine/port restoration
- Light rail (transportation)
- Agricultural facilities
- Pulp and paper mills
- Parking structures
- Tunnels
- Balconies in coastal environments
- Outdoor railings in coastal environments



Anchor Products for Corrosive Environments

Type 304 Stainless Steel

- Stadium seating
- Curtain walls
- Clean rooms
- Central utility plant facilities
- Food-processing facilities
- Ledger bolts for decks
- DOT signs and fixtures
- Cooling towers
- Scaffolding
- Parking structures
- Tunnels
- Balconies
- Refineries
- Breweries and wineries
- Fencing
- Outdoor railings

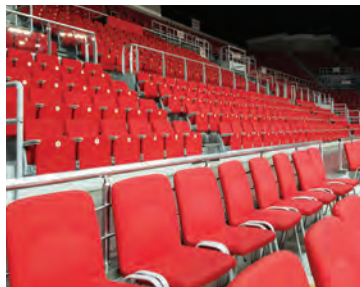

Light-Frame Construction



Anchoring Adhesives



SET-3G™



AT-XP®



SET-XP®



ET-HP®

Mechanical Anchors



Titen HD®



Titen HD® SS



Strong-Bolt® 2 SS



Wedge-All® SS



Titen® 2

Direct Fastening Systems



Powder-Actuated Systems



PDPAWL



PDPA

Light-Frame Construction

Speed Clean™ DXS



DXS Drill Bit

Carbide Drill Bits



Framing Hardware (New and Retrofit)



Anchoring adhesives, Titen HD®, Strong-Bolt® 2, Wedge-All®

Post Bases for Decks, Railings and Patio Covers



Ledgers



Anchoring adhesives, Titen HD (interior only unless using a stainless-steel version of the anchor), Strong-Bolt 2, Wedge-All



Structural Beams



Anchoring adhesives, Strong-Bolt 2 SS, Wedge-All SS



Anchoring adhesives, Strong-Bolt 2, Wedge-All

Retrofit and Repair



Anchoring Adhesives



SET-3G™



AT-XP®



SET-XP®



ET-HP®



SET



Opti-Mesh Screen Tube



Steel Screen Tube



Piston Plug

Mechanical Anchors



Titen HD®



Titen HD® SS



Strong-Bolt® 2 SS



Wedge-All® SS



Sleeve-All SS



Titen® 2



Drop-In



Drop-In SS

Retrofit and Repair

Composite Strengthening Systems™ (CSS)

FRP, FRCM, Laminate, FRP Anchors, Saturant/Paste, Coatings



Rebar and Smooth Dowelling



Anchoring adhesives

Seismic Retrofit / Structural Renovation



Anchoring adhesives, Strong-Bolt® 2, Titen HD®, Wedge-All®

Architectural Attachments



Anchoring adhesives, Strong-Bolt 2, Titen HD, Wedge-All, Titen® screw

Concrete Formwork



Coil Thread Drop-In, Titen HD, DSD, Strong-Bolt 2, Wedge-All

Concrete / URM Retrofit



CSS laminates and CSS-EP

Crack Injection



ETI Injection Epoxy



ETI-SLV



ETI-LV



ETI-GV



Crack-Pac®



Crack-Pac®
Flex-H₂O™

Paste-Over and Crack Sealants



CIP-LO



CIP-F



ETR-16

Accessories



Optimix® Mixing Nozzle



E-Z-Click
Ports and Injection Fitting



EIPX-EZ Corner-Mount/
Drilled-In Port



EIP-EZA
Flush-Mount Port

Crack Injection

Crack Injection in Concrete Slabs, Walls, Columns and Beams to Restore Structural Integrity



ETI-SLV, ETI-LV, ETI-GV

Gravity Feed for Cracks in Floors



ETI-SLV, ETI-LV, ETI-GV, Crack-Pac®, Crack-Pac Flex-H₂O™

Crack Injection in Swimming Pools



ETI-SLV, ETI-LV, ETI-GV, Crack-Pac, Crack-Pac Flex-H₂O

Dowels to Reinforce Replaced Concrete

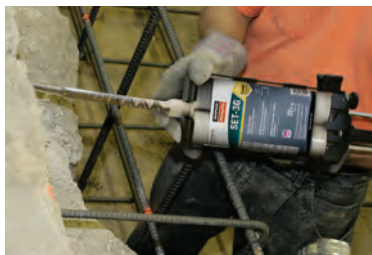

Anchoring adhesives

Wastewater / Water Treatment



For more information, please visit strongtie.com/solutions/wastewater.



Flier S-A-WWT

Anchoring Adhesives



SET-3G™

AT-XP®

SET-XP®

ET-HP®

Mechanical Anchors



Titen HD®

Titen HD® SS

Strong-Bolt® 2 SS

Wedge-All® SS

Sleeve-All SS

Drop-In SS

Crack Injection – ETI Injection Epoxy



ETI-SLV

ETI-LV

ETI-GV

Crack-Pac®

Crack-Pac®
Flex-H2O™

Wastewater / Water Treatment

Composite Strengthening Systems™ (CSS)

FRP, FRCM, Laminate, FRP Anchors, CSS-UES, Underwater Saturant, Paste, Coatings

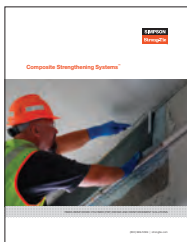

Crack Injection — Paste-Over and Crack Sealants



CIP-LO



CIP-F

Speed Clean™ DXS



DXS Drill Bit



ETR-16

Carbide Drill Bits



Pumps and Equipment



Anchoring adhesives, Titen HD®, Strong-Bolt® 2, Wedge-All®

Concrete / URM Retrofit



CSS laminates and CSS-EP

Gates



Anchoring adhesives, Strong-Bolt 2 SS, Titen HD SS, Wedge-All SS

Pipe Supports



Drop-In, Strong-Bolt 2, Wedge-All, THD-RH

Bridge and Marine



Anchoring Adhesives



SET-3G™



AT-XP®



SET-XP®



ET-HP®



SET

Mechanical Anchors



Titen HD®



Titen HD® SS



Strong-Bolt® 2



Wedge-All®



Sleeve-All



Drop-In



Drop-In SS



Titen® 2

All available in stainless steel.

Bridge and Marine

Concrete Formwork



Drop-In SS, Titen HD® SS, Strong-Bolt® 2 SS, Wedge-All® SS

Barriers and Guardrails



Anchoring adhesives

Heavy- and Light-Duty Signs



Anchoring adhesives, Strong-Bolt 2 SS, Titen HD SS, Wedge-All SS

Attaching Precast Elements



Anchoring adhesives, Strong-Bolt 2 SS, Titen HD SS, Wedge-All SS

Dowels for Jersey Barriers



Anchoring adhesives

Glare Screens



Anchoring adhesives, Strong-Bolt 2 SS, Titen HD SS, Wedge-All SS

Pile Repair



FX-70® structural piling repair and protection system

Composite Strengthening Systems™ (CSS)



FRP, FRCM, Laminate, FRP Anchors, Saturant/Paste, Coatings



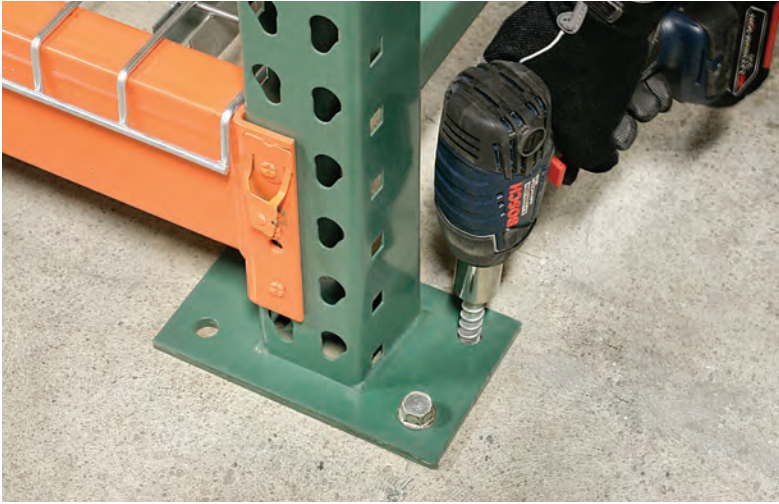

Anchoring Adhesives



SET-3G™



AT-XP®



SET-XP®



ET-HP®



SET

Mechanical Anchors



Titen HD®



Titen HD® SS



Titen HD® CS



Strong-Bolt® 2



Strong-Bolt® 2 SS



Wedge-All®



Wedge-All® SS



Titen® 2

Racking



Strong-Bolt® 2, Titen® HD, Wedge-All®

Dock Doors and Bumpers



Anchoring adhesives, Strong-Bolt 2 SS, Titen HD SS, Wedge-All SS

Conveyors and Rollers



Anchoring adhesives, Strong-Bolt 2, Titen HD, Wedge-All

Steel Beams / Columns



Anchoring adhesives, Strong-Bolt 2, Titen HD, Wedge-All

Stadium Seating



Anchoring adhesives, Strong-Bolt 2, Titen HD, Wedge-All

Awnings



Anchoring adhesives, Strong-Bolt 2, Titen HD, Wedge-All

Composite Strengthening Systems™



FRP / FRCM

FRP, FRCM, Laminate, FRP Anchors, CSS-UES Underwater Saturant/Paste, Coatings



Crack Injection — ETI Injection Epoxy



ETI-SLV



ETI-LV



ETI-GV



Crack-Pac®



Crack-Pac®
Flex-H2O™

Paste-Over and Crack Sealants



CIP-LO



CIP-F



ETR-16

Composite Strengthening Systems™

Applications:

Seismic Retrofit

- Shear strengthening
- Displacement/ductility
- Life safety

Load Rating Upgrade

- Increased loads
- New equipment
- Change of use

Damage Repair

- Deterioration/corrosion
- Blast/vehicle impact

Defect Remediation

- Size/layout errors
- Low concrete strengths

Blast Mitigation

- Hardening
- Progressive collapse

Buildings



Underwater



Bridges



Piers and Wharfs



Tanks / Silos



Tunnels

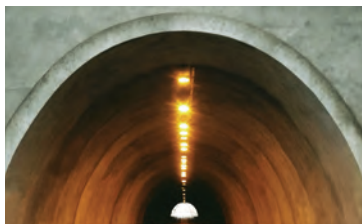

Parking Structures



Pipes



Cold-Formed Steel Construction



Mechanical Anchors



Titen HD®



Strong-Bolt® 2



Wedge-All®



Titen HD®
Rod Hanger



Crimp Drive



Titen® 2



CSD
Split-Drive

Direct Fastening Systems



Powder-Actuated Systems



Gas-Actuated System



PDPAWL



PDPA



PDPAT



GDP



GDPS

Cold-Formed Steel Construction

Steel Curtain Walls



Concrete Floor Slab

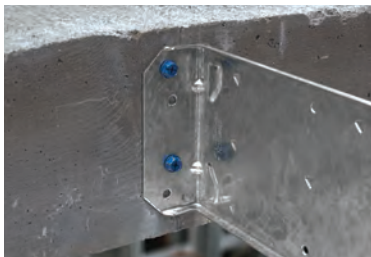

Titen® 2 screw

Interior Base / Ceiling Track



Titen HD®, Split-Drive, anchoring adhesives, direct fastening systems

Masonry Veneer Ledger



Anchoring adhesives, Titen HD, Strong-Bolt® 2, Wedge-All®

Drywall Track



Direct fastening systems

Ceiling Track



Direct fastening systems

Non-Top Supported Wall Braces



RCKW kneewall connectors with a two-anchor option that accommodates ½"- or ¾"-diameter concrete anchors

Framework Mullions



Titen HD, Strong-Bolt 2, Wedge-All, direct fastening systems

Length Identification Head Marks

General Installation Guide / Instructions

The following tables define the length of various Simpson Strong-Tie® mechanical anchors based upon the letter stamped on the anchor head. The lengths represented are in inches.

This information pertains to the following Simpson Strong-Tie mechanical anchors:

- Strong-Bolt® 2
- Wedge-All®
- Sleeve-All®

Length Identification Head Marks

Mark	Units	A	B	C	D	E	F	G	H	I
From	in.	1½	2	2½	3	3½	4	4½	5	5½
Up To But Not Including	in.	2	2½	3	3½	4	4½	5	5½	6

Length Identification Head Marks

Mark	Units	J	K	L	M	N	O	P	Q	R
From	in.	6	6½	7	7½	8	8½	9	9½	10
Up To But Not Including	in.	6½	7	7½	8	8½	9	9½	10	11

Length Identification Head Marks

Mark	Units	S	T	U	V	W	X	Y	Z
From	in.	11	12	13	14	15	16	17	18
Up To But Not Including	in.	12	13	14	15	16	17	18	19

Acceptable Hole Diameter

Mechanical Anchors

Pre-Load Relaxation

Expansion anchors that have been set to the required installation torque in concrete will experience a reduction in pre-tension (due to torque) within several hours. This is known as pre-load relaxation. The high compression stresses placed on the concrete cause it to deform which results in a relaxation of the pre-tension force in the anchor. Tension in this context refers to the internal stresses induced in the anchor as a result of applied torque and does not refer to anchor capacity. Historical data shows it is normal for the initial tension values to decrease by as much as 40–60% within the first few hours after installation. Retorquing the anchor to the initial installation torque is not recommended or necessary.

Adhesive Anchors

Installation into Green Concrete

The strength design data for adhesive anchors in this catalog are based on installations into concrete that is at least 21 days old. Anchors may be installed in concrete less than 21 days old, provided a reduction factor is applied to bond strength:

Products	Concrete Age When Installed	Concrete Age When Loaded	Bond Strength Factor
AT, AT-XP®, ET-HP®, SET, SET-XP®, SET-3G™	14 days	21 days	1.0
		14 days	0.9
	7 days	21 days	1.0
		7 days	0.7

Oversized Holes

The performance data for adhesive anchors are based upon anchor tests in which holes were drilled with carbide-tipped drill bits of the same diameter listed in the product's load table. Additional static tension tests were conducted to qualify anchors installed with SET, SET-3G, SET-XP and ET-HP adhesives for installation in holes with diameters larger than those listed in the load tables. The tables indicate the acceptable range of drilled hole sizes and the corresponding tension-load reduction factor (if any). The same conclusions also apply to the published shear load values. Drilled holes outside of the accepted range shown in the charts are not recommended.

SET Adhesive — Acceptable Hole Diameter

Insert Diameter (in.)	Acceptable Hole Diameter Range (in.)	Acceptable Load Reduction Factor
3/8	1/2 – 3/4	1.0
1/2	5/8 – 1 5/16	1.0
5/8	3/4 – 1 1/8	1.0
3/4	7/8 – 1 5/16	1.0
7/8	1 – 1 1/2	1.0
1	1 1/8 – 1 11/16	1.0
1 1/8	1 1/4 – 1 7/8	1.0
1 1/4	1 3/8 – 2 1/16	1.0
1 3/8	1 1/2 – 2 1/4	1.0

Acceptable Hole Diameter

Adhesive Anchors (cont.)

Oversized Holes

SET-XP® and ET-HP® Adhesives — Acceptable Hole Diameter

Insert Diameter (in.)	Acceptable Hole Diameter Range (in.)	Acceptable Load Reduction Factor
1/2	5/8 – 3/4	1.0
5/8	3/4 – 15/16	1.0
3/4	7/8 – 1 1/8	1.0
7/8	1 – 1 5/16	1.0
1	1 1/8 – 1 1/2	1.0
1 1/4	1 3/8 – 1 7/8	1.0

AT-XP® and SET-3G™ Adhesives — Acceptable Hole Diameter

Insert Diameter (in.)	Acceptable Hole Diameter Range (in.)	Acceptable Load Reduction Factor
3/8	7/16 – 1/2	1.0
1/2	9/16 – 5/8	1.0
5/8	1 1/16 – 3/4	1.0

Core-Drilled Holes

The performance data for adhesive anchors are based upon anchor tests in which holes were drilled with carbide-tipped drill bits. Additional static tension tests were conducted to qualify anchors installed with SET anchoring adhesives for installation in holes drilled with diamond-core bits. In these tests, the diameter of the diamond-core bit matched the diameter of the carbide-tipped drill bit recommended in the product's load table. The test results showed that no reduction of the published allowable tension load for SET anchoring adhesives is necessary for this condition. The same conclusions also apply to the published allowable shear loads.

Acceptable Hole Diameter

Adhesive Anchors (cont.)

Installation in Damp, Wet and Submerged Environments

SET-XP®, SET-3G™, ET-HP® and AT-XP®: The performance data for adhesive anchors using SET-XP, SET-3G, ET-HP and AT-XP adhesives are based upon tests according to ICC-ES AC308. This criteria requires adhesive anchors that are to be installed in outdoor environments to be tested in water-saturated concrete holes that have been cleaned with less than the amount of hole cleaning recommended by the manufacturer. A product's sensitivity to this installation condition is considered in determining the product's "Anchor Category" (strength reduction factor).

SET-XP, ET-HP and AT-XP may be installed in dry or water-saturated concrete. SET-3G may be installed in dry, water-saturated or water-filled holes in concrete.

Based on Reliability Testing per ICC-ES AC308

- **Dry Concrete** — Cured concrete whose moisture content is in equilibrium with surrounding non-precipitate atmospheric conditions.
- **Water-Saturated Concrete** — Cured concrete whose internal aggregate materials are soaked with moisture.
- **Submerged Concrete** — Cured concrete that is covered with water and water saturated.
- **Water-Filled Hole** — Drilled hole in water-saturated concrete that is clean yet contains standing water at the time of installation.

SET: The performance data for adhesive anchors using SET adhesive are based upon tests in which anchors are installed in dry holes. Additional static tension tests were conducted for some products in damp holes, water-filled holes and submerged holes. The test results show that no reduction of the published allowable tension load is necessary for SET adhesive in damp holes, or for SET adhesive in water-filled holes. For SET adhesive in submerged holes, the test results show that a reduction factor of 0.60 is applicable. The same conclusions also apply to the published allowable shear load values.

Based on Reliability Testing per ICC-ES AC58

- **Dry Concrete** — Cured concrete whose moisture content is in equilibrium with surrounding non-precipitate atmospheric conditions.
- **Damp Hole** — A damp hole, as defined in ASTM E1512 and referenced in ICC-ES AC58, is a drilled hole that has been properly drilled, cleaned and then is filled with standing water for seven days. After seven days, the standing water is blown out of the hole with compressed air and the adhesive anchor is installed.
- **Water-Filled Hole** — A water-filled hole is defined similarly to a damp hole; however, the standing water is not blown out of the hole. Instead, the adhesive is injected directly into the water-filled hole (from the bottom of the hole up) and the insert is installed.
- **Submerged Hole** — A submerged hole is similar to a water-filled hole with one major exception — in addition to standing water within the hole, water also completely covers the surface of the base material. Note that drilling debris and sludge should be removed from the drilled hole prior to installation. ICC-ES AC58 does not address this condition.

Alphabetical Index of Products

AMN	Acrylic Mixing Nozzle	30
ARC	Adhesive Retaining Caps	33
AT-XP	Acrylic Adhesive	26
ATS	Acrylic Screens	36
CD	Crimp Drive® Anchor	104
CDT10S	Adhesive Dispensing Tool	28
CIP-F	Crack Injection Paste Over	148
CIP-LO	Low Odor Crack Injection Paste Over	148
CPFH	Crack-Pac® Flex-H ₂ O™ Crack Sealer	146
CSD	Countersunk Split Drive	107
CSS	Composite Strengthening Systems™	170
DIA	Drop-In Anchor	96
DIAB	Drop-In Anchor	90
DSD	Duplex Head Split Drive	107
DXS	Speed Clean™ Drill Bits for Concrete and Masonry	40
EIF	Injection Fitting	150
EIP	Injection Port	150
EMN	Epoxy Mixing Nozzle	30
ET-HP®	Epoxy Adhesive	22
ETB	Hole-Cleaning Brush	31
ETBR	Hole-Cleaning Brush	31
ETBS	Hole-Cleaning Brush	31
ETI	Crack Injection Epoxy	142
ETIPAC	Crack-Pac® Injection Epoxy	144
ETR	Epoxy Paste	149
ETS	Epoxy Screens	36
EWSP	Opti-Mesh Adhesive-Anchoring Screen Tube	34
EZAC	Easy-Set Pin-Drive Anchor	73
E-Z-Click	Injection System	150
FX-70®	Structural Pile Repair and Protection System	166
FX-207	Slurry Seal	173
FX-505	Water-Based Acrylic Coating	173
GAC	Gas-Actuated Ceiling Clip	121
GCC	Gas-Actuated Conduit Clip	121
GCL	Gas-Actuated Conduit Clamp	121

Alphabetical Index of Products

GCN-MEP	Gas-Actuated Concrete Nailer	116
GCT	Gas-Actuated Tie Strap Holder	121
GDP	Collated Gas-Drive Pins	118
GDPS	Collated Gas-Drive Step-Shank Pins	118
GDPSK	Collated Spiral-Knurled Gas Pins	119
GFC	Gas Fuel Cell	120
GRH	Gas-Actuated Threaded Rod Holder	121
GTH	Gas-Actuated Top Hat Pin	121
GTS	Gas-Actuated ¼" Threaded Stud	121
GW	Gas-Actuated Dome Washer Pin	121
HDIA	Hollow Drop-In Anchor	98
HELI	Heli-Tie Helical Wall and Stitching Tie	160
PBXDP	BX Cable Strap	137
PCC	Conduit Clip	137
PCLDPA	Ceiling Clip	135
PDPA	0.157" Shank Diameter Drive Pin	133
PDPAS	Collated 0.157" Shank Diameter Drive Pin	134
PDPAT	0.157" Shank Diameter Tophat Fastener	135
PDPAWL	0.157" Shank Diameter with 1" Metal Washer	134
PECLDPA	Ceiling Clip	135
PHBC	Highway Basket Clip	136
PHD	¼"-Headed Hammer Drive Fastener	138
PHT-38	Manual Hammer Tool	138
PINW	0.300" Headed Pin with 1 7/16" Metal Washer	136
PINWP	0.300" Headed Pin with 1 3/8" Plastic Washer	136
PKP	Concrete Forming Pin	138
PP	Piston Plug	33
PSLV3	¾" Threaded Stud	137
PT-22A	0.22 Cal. Powder-Actuated Tool	128
PT-22HA	0.22 Cal. Single-Shot Hammer-Actuated Tool	130
PT-27	0.27 Cal. Semi-Automatic Powder-Actuated Tool	126
PTP-27L	0.27 Cal. Automatic Powder-Actuated Tool	124
PTRHA	0.157" Shank Diameter Threaded Rod Hanger	135
RFB	Retrofit Bolt	38
RND	Rod Hanger Nut Driver	85

Alphabetical Index of Products

RSH	Steel Rod Hanger – Horizontal	85
RSV	Steel Rod Hanger – Vertical	85
RWH	Wood Rod Hanger – Horizontal	88
RWW	Wood Rod Hanger – Vertical	88
SET	Epoxy Adhesive	24
SET-3G™	Epoxy Adhesive	18
SET-XP®	Epoxy Adhesive	20
SL	Sleeve-All® Anchor	70
STB2	Strong-Bolt® 2 Wedge Anchor	62
STB2 SS	Strong-Bolt® 2 Type 304 Stainless-Steel Wedge Anchor	62
SWN	Sure Wall Anchor – Nylon	109
SWZ	Sure Wall Anchor – Zinc	109
THD	Titen HD® Heavy-Duty Screw Anchor	52
THD CS	Titen HD® Countersunk Screw Anchor	58
THD RC	Titen HD® Rod Coupler	60
THD RH	Titen HD® Rod Hanger	83
THD SS	Stainless-Steel Titen HD® Heavy-Duty Screw Anchor	56
TTN2	Titen® 2 Concrete and Masonry Screw	76
TTN SS	Titen® Stainless-Steel Concrete and Masonry Screw	79
TW	Tie Wire Anchor	75
WA	Wedge-All® Anchor	66
ZN	Zinc Nailon™	102

Stainless-Steel Titen HD® Heavy-Duty Screw Anchor



Available in
 $\frac{1}{4}$ " diameter
Type 304
stainless steel.

Diameters of
 $\frac{3}{8}$ ", $\frac{1}{2}$ ", $\frac{5}{8}$ " and
 $\frac{3}{4}$ " available
in Types 316
and 304.



Our code-listed Titen HD® heavy-duty screw anchor is now available in Types 316 and 304 stainless steel to resist corrosion and maintain the structural integrity of concrete. Type 316 is the optimal choice for applications in corrosive or severe environments such as near chemicals or salt water. Type 304 is a cost-effective solution for less extreme applications, including in wet, moist or damp environments.

To learn more about the stainless-steel Titen HD, visit go.strongtie.com/titenhdss or call (800) 999-5099.

SIMPSON

Strong-Tie

The best adhesive performs in the worst conditions.



The next generation of Simpson Strong-Tie® epoxy adhesive is more reliable and versatile. With a code report ICC-ES ESR-4057, the high-strength SET-3G™ anchoring adhesive performs in extreme in-service temperatures (from -40°F to 176°F) as well as in dry or water-saturated concrete environments to provide the high bond strength values and performance needed for adhesive anchoring applications on your projects.

Specify SET-3G adhesive for your next project. Visit strongtie.com/set3g or call us at (800) 999-5099.

