



Trex[®]

THE GUIDE TO

Trex Deck Railing

Your guide to everything railing

With railing options for all builds and budgets, it's never been easier to make the Trex decision that's right for you.™

Look for design tips, ordering help and ways to simplify railing decisions.



FIND A BUILDER



ORDERING HELP



DESIGN HELP

HOME



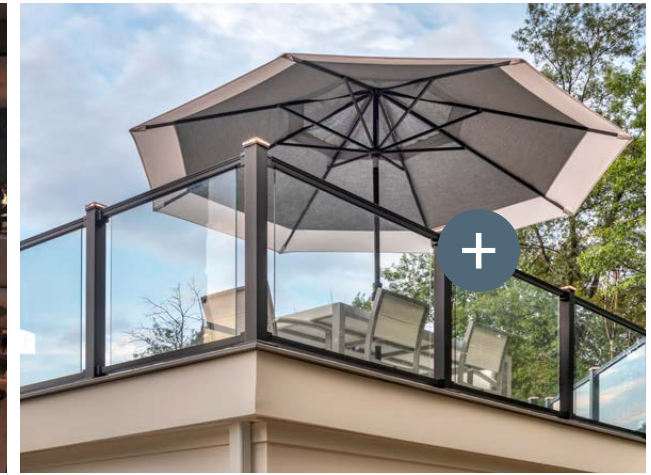
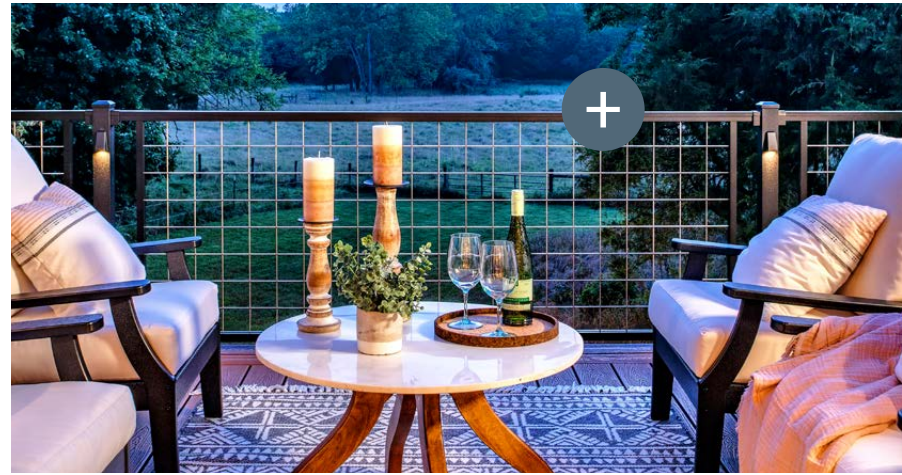
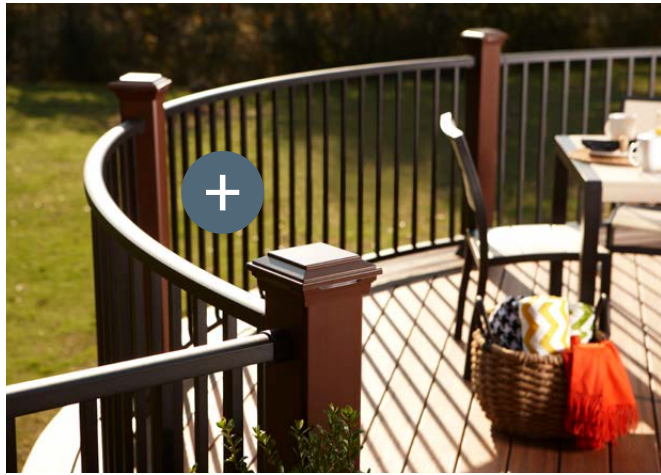

Discover all the things you can do with Trex® railing

Railing features

- ▶ Built with the same outstanding durability as Trex decking – your outdoor railing won't rot, peel or splinter.
- ▶ Innovation without waste: All of our eco-friendly railing is made of a minimum of 40% recycled materials.
- ▶ Deck railing kits, pre-assembled panels and online resources makes installation simple.



Looks you'll love

Paired with the features you need.

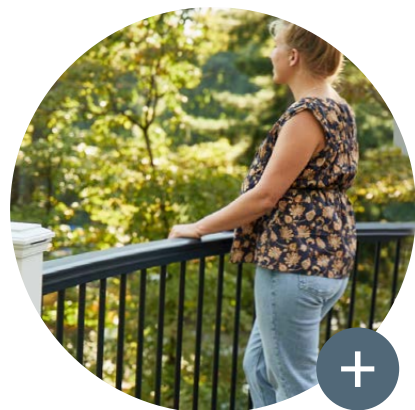

Make it yours

Go the custom route and tap into our expertise. Or, design it yourself.



Ways to simplify

Find ways to make railing installation easy.



Meet the lineup

Choose the Trex deck and railing system that is right for your project.



Looks
you'll love

Paired with the
features you need.

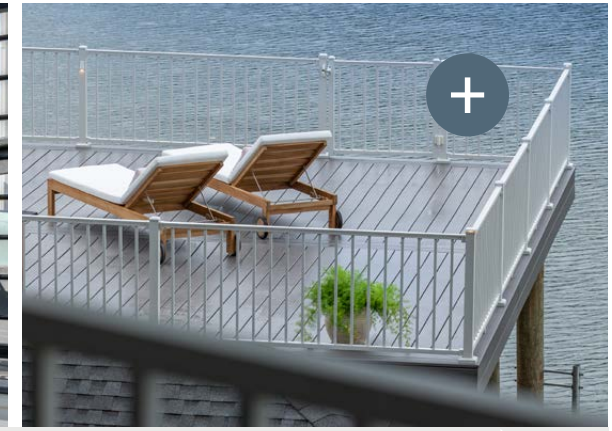

I was worried that the railing was going to be difficult to install, *but it was actually a really straightforward process!*

The instructions were easy to follow, and it went up much more quickly than we had anticipated.

CHARLEE OF BUILD & CREATE HOME

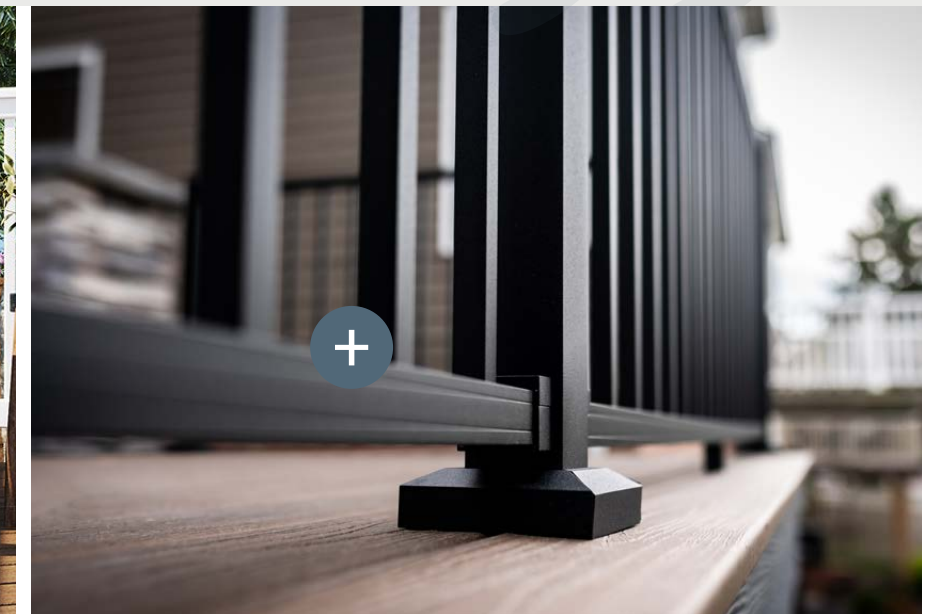
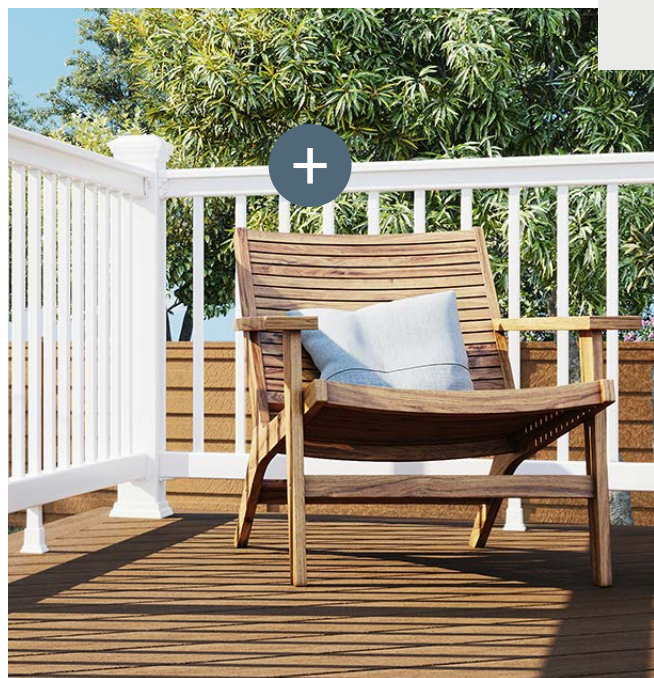

Railing anatomy

There are several key components of a railing section that help you lean into the view.

TREX SIGNATURE® X-SERIES™ RAILING

Offers specialty infill options for more design flexibility. Choose from Cable Rail or Frameless Glass.

X-SERIES
POST



ALUMINUM
POST



ALUMINUM BALUSTERS OR INFILL PANELS

Individual columns or full expanses maintain space and safety. Choose from Aluminum, Mesh, Rod Rail or Glass.

COMPOSITE RAILS & BALUSTERS

Top and bottom rails provide stability and structure.

POST
CAP

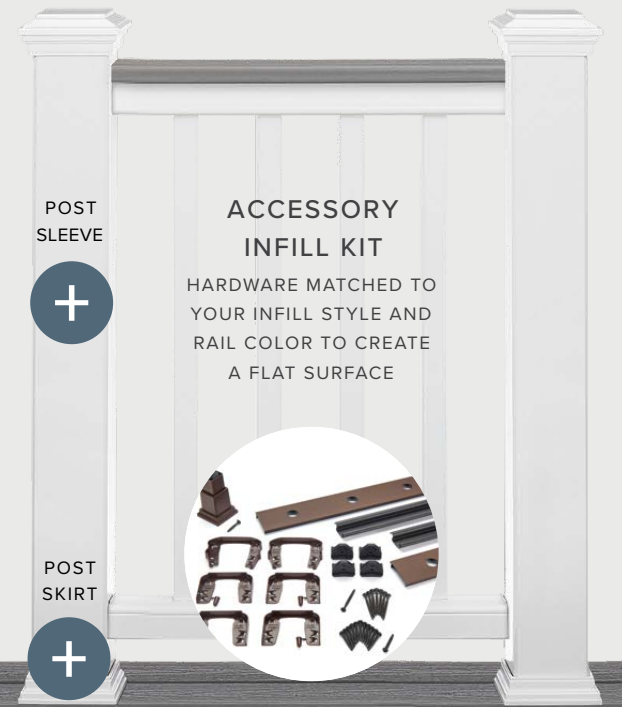

POST
SLEEVE



POST
SKIRT



ACCESSORY INFILL KIT

HARDWARE MATCHED TO
YOUR INFILL STYLE AND
RAIL COLOR TO CREATE
A FLAT SURFACE



FIND A BUILDER



ORDERING HELP



DESIGN HELP

HOME



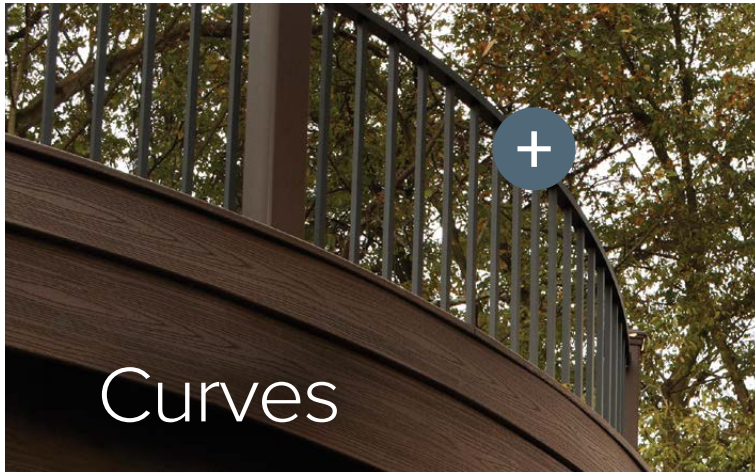

Curves

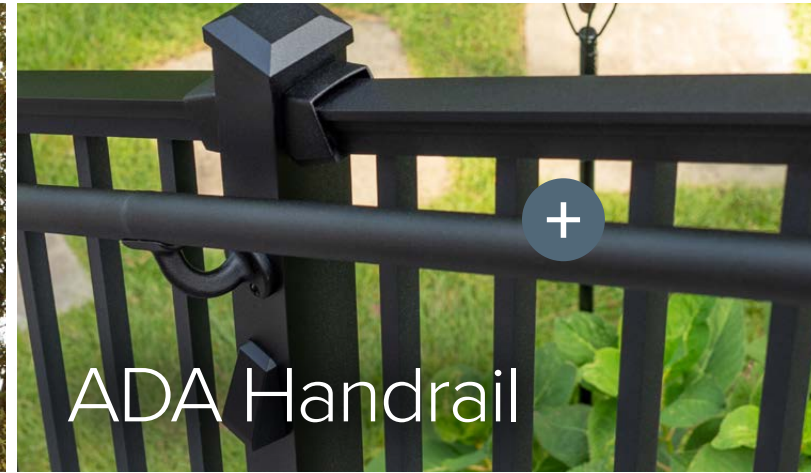

ADA Handrail

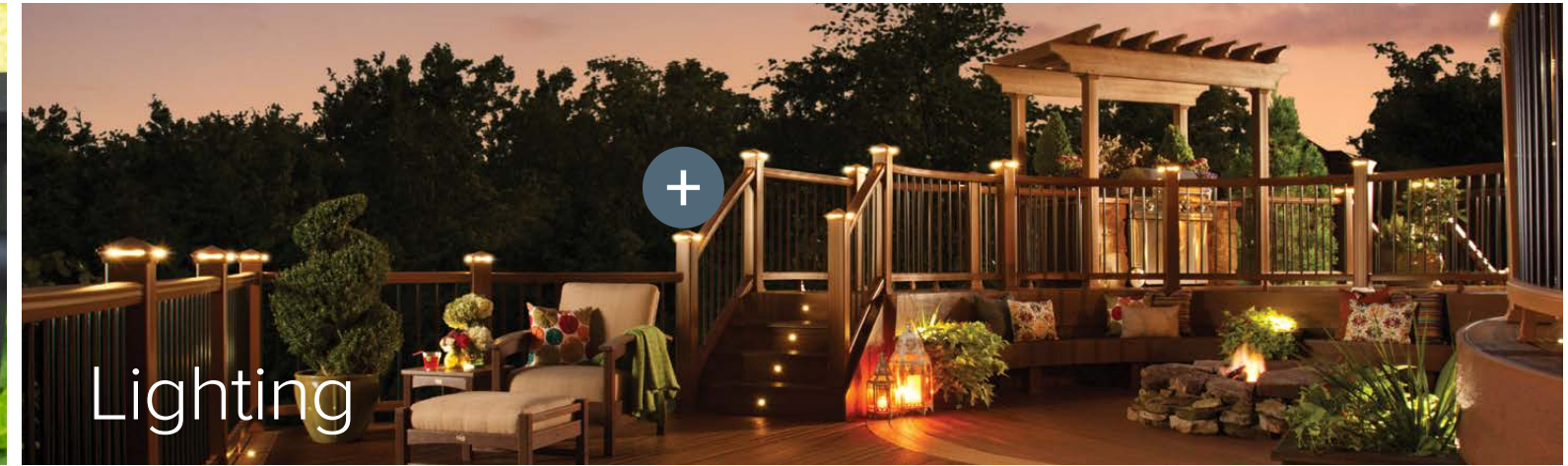

Lighting

MAKE IT YOURS

Customize your design with Trex

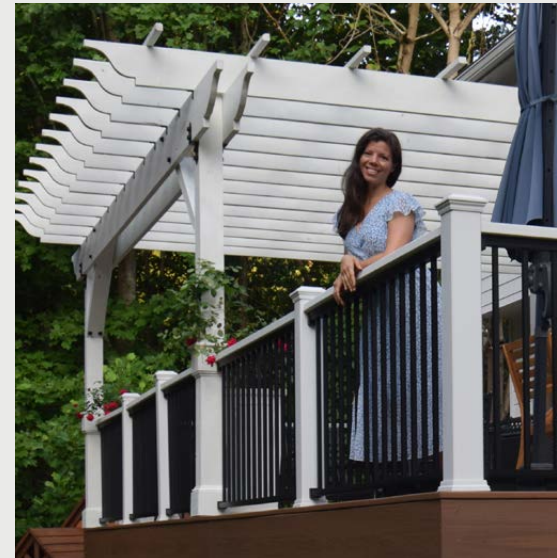

My only concern when choosing Trex Signature® Railing was how was I going to do a DIY install if I had to cut the aluminum. I quickly learned, thanks to Trex® Academy™, that it could be *cut with a circular saw that I had on hand, and wouldn't require any special tools.*

EMILY MADE HOME

TOP QUESTIONS TO ASK YOURSELF

- ▶ What is my style?
- ▶ What add-ons do I want?
- ▶ How much can I spend?
- ▶ How much do I want to customize my look?
- ▶ What maintenance is required for the looks I like?
- ▶ How do I want to use my outdoor space?

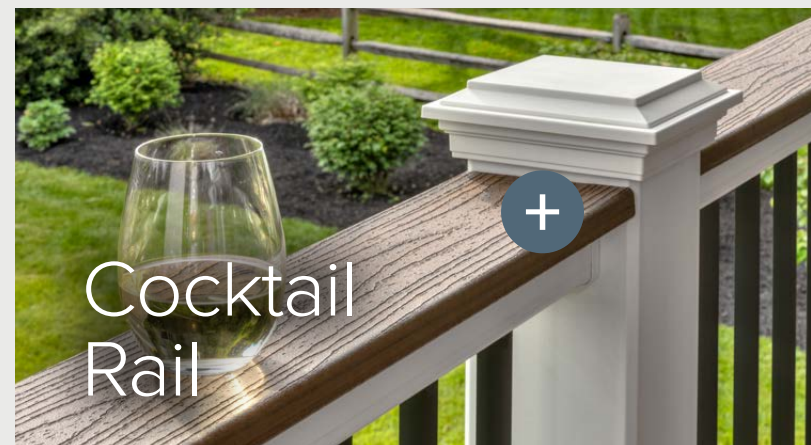

Cocktail Rail



Aluminum Gates



FIND A BUILDER



ORDERING HELP



DESIGN HELP

HOME





Ways to simplify

Railing is complicated. Let us make it easy.

Lean on the experts,



FIND INSPIRATION



FIND A BUILDER



CURATE YOUR LOOK

or, do it yourself.



RAILING TEMPLATES



PRE-ASSEMBLED PANELS



RAILING KITS

Need Help With Your Build?

Trex® Academy™ is your one-stop shop for everything you need to learn how to build your new deck, whether it's tutorial videos, pro-tips, or installation.



Shop Local

Buy Trex decking and railing materials and supplies near you.

MEET THE LINEUP



FIND A BUILDER



ORDERING HELP



DESIGN HELP

HOME



Increase outdoor sophistication & style X-ponentially

Trex Signature
X-SERIES™ RAILING

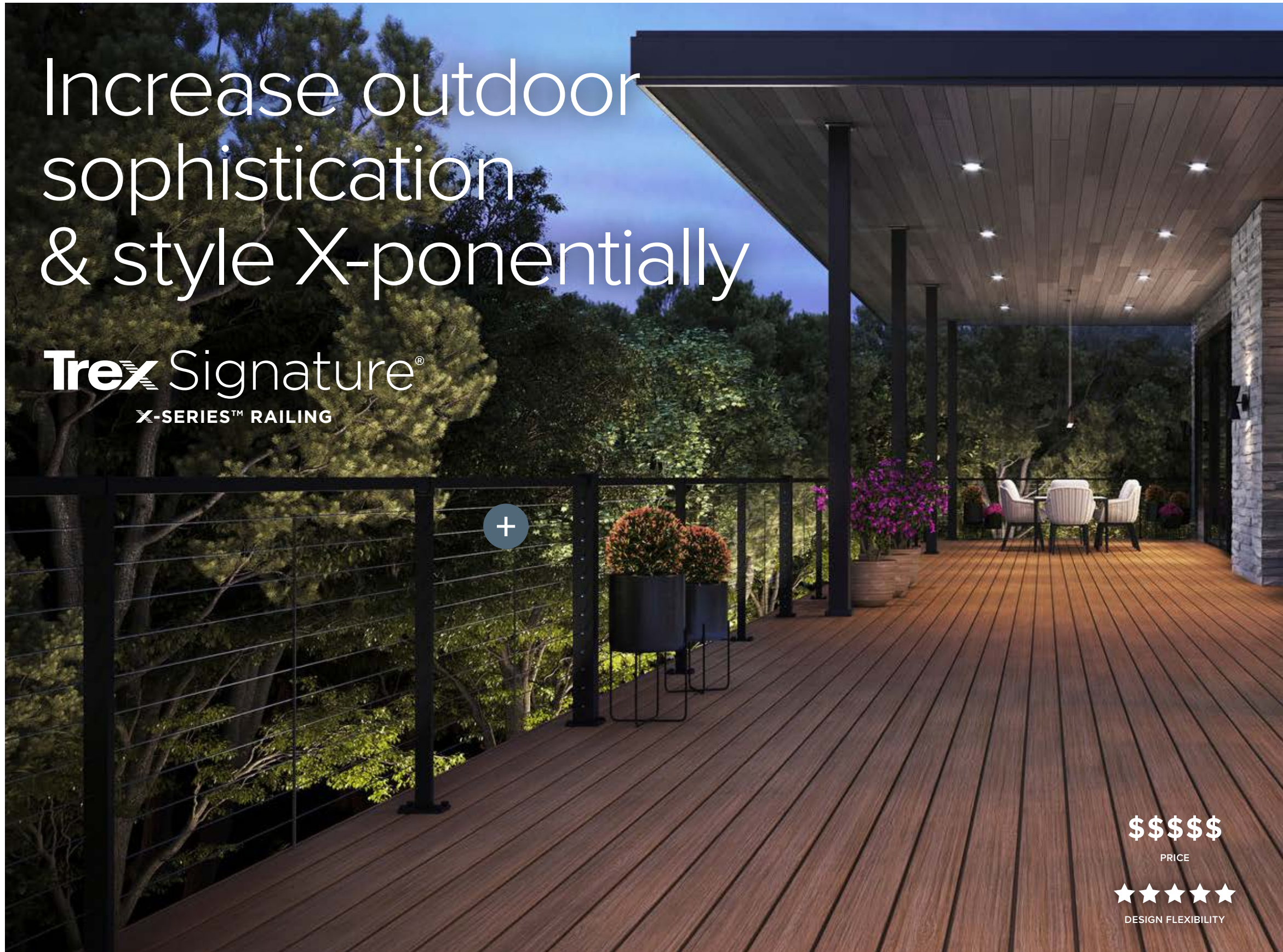

\$\$\$\$\$

PRICE



DESIGN FLEXIBILITY

TREX SIGNATURE® X-SERIES™ CABLE RAIL

The X-Series anchor post can be configured for use as an end, line and corner post. Novel spring-loaded cables provide optimal tension management.

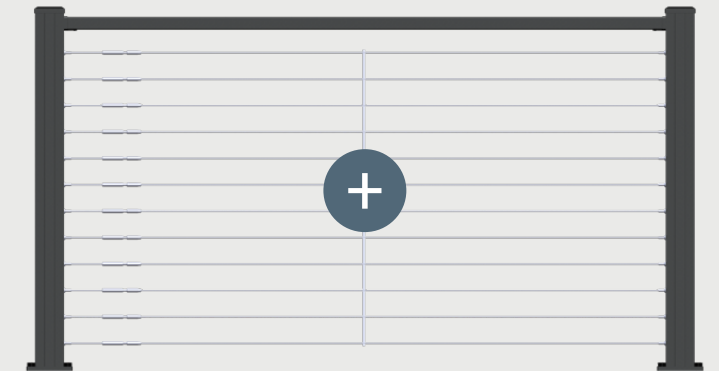

Posts & Rails

CHARCOAL BLACK

Infill

STAINLESS STEEL CABLES

TREX SIGNATURE® X-SERIES™ FRAMELESS GLASS RAIL

Modern, streamlined design.

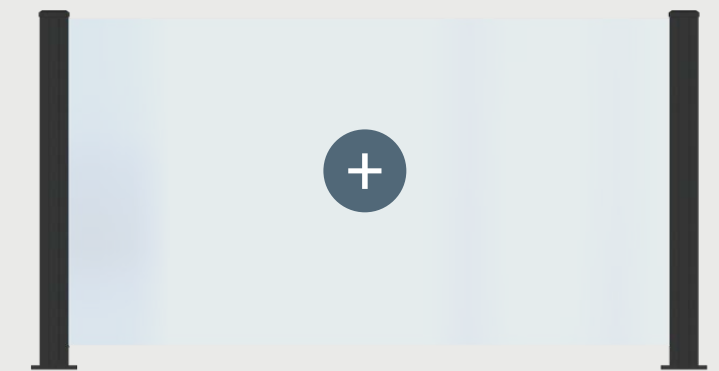

Posts

CHARCOAL BLACK

Infill

FRAMELESS GLASS



FIND A BUILDER



ORDERING HELP



DESIGN HELP

HOME



Effortless style, exceptional strength

TrexSignature[®]
RAILING



\$\$\$\$

PRICE



DESIGN FLEXIBILITY

GLASS



MESH



CLEAN, SLEEK, ELEGANT
RAILING TO LET YOUR
VIEW SHINE THROUGH



Made from premium aluminum, with four unique
infills to complement any design aesthetic.

ROD RAIL

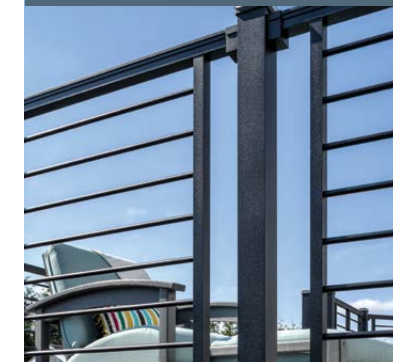

ALUMINUM



Aluminum Posts,
Rails & Balusters

CLASSIC
WHITE

BRONZE

CHARCOAL BLACK

Other Infill Panels

STAINLESS STEEL MESH

GLASS



FIND A BUILDER



ORDERING HELP



DESIGN HELP

HOME



Timeless design you can trust – and tailor

Trex Transcend
RAILING



\$\$\$

PRICE



DESIGN FLEXIBILITY



MIX & MATCH

Transcend railing offers you the freedom to combine colors and materials.

Composite: top & bottom rails, square balusters		Aluminum: round balusters	
CLASSIC WHITE	ROPE SWING	CLASSIC WHITE	BRONZE
CHARCOAL BLACK	VINTAGE LANTERN	CHARCOAL BLACK	CHARCOAL BLACK



FIND A BUILDER



ORDERING HELP



DESIGN HELP

HOME



The simple choice for your backyard

Trex Select[®]
RAILING



\$\$

PRICE

★★

DESIGN FLEXIBILITY

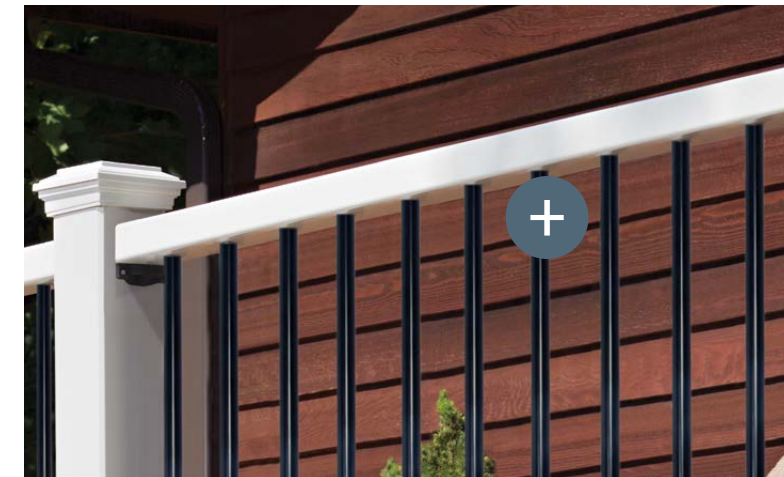

NOW OFFERED IN TWO UNIQUE DESIGN CONFIGURATIONS

Crisp, safe and effective, Trex Select Railing makes it simple by combining composite rails with your choice of balusters. Choose Select Classic or the new T-Rail top rail with two baluster options for clean yet stunning designs.

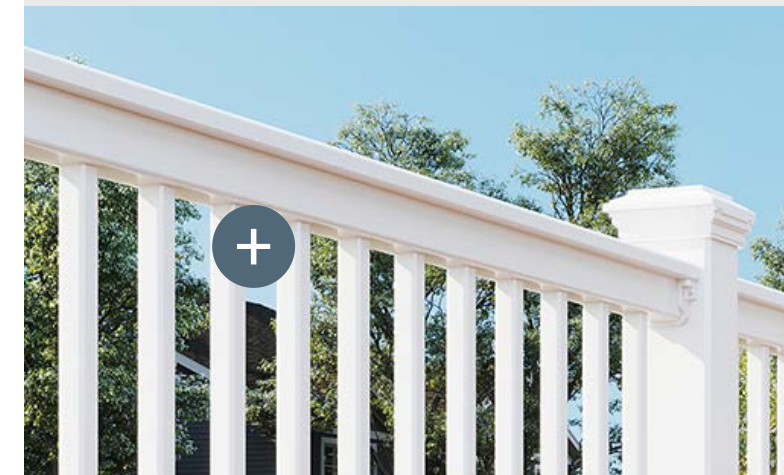

Composite: top & bottom rails, square balusters*

Aluminum: round balusters

CLASSIC WHITE

CHARCOAL BLACK

*White square composite baluster option is only available for Select T-Rail.



FIND A BUILDER



ORDERING HELP



DESIGN HELP

HOME



TREX SIGNATURE® X-SERIES™ RAILING



	CABLE RAIL	FRAMELESS GLASS
	RAIL KITS	
POSTS & RAILS	Aluminum	
INFILLS	Stainless Steel Cables	Laminated Glass Panel ²
AVAILABLE RAIL AND BALUSTER COLORS	1 Top rail color Infill is stainless steel cable	1 Color
CURVABLE ³		
COCKTAIL RAIL ⁴		
COST	\$\$\$\$\$	
STYLE	MODERN	

TREX SIGNATURE® RAILING



	ALUMINUM	ROD RAIL	GLASS	MESH PANEL
	RAIL KITS			
POSTS & RAILS	Aluminum			
INFILLS	Square Aluminum Balusters OR Round Aluminum Balusters ¹	Aluminum Rods	Glass Panel ²	Mesh Panel
AVAILABLE RAIL AND BALUSTER COLORS	3 Top and bottom rail and baluster colors	1 Rod Rail top & bottom rail color 1 Rod color	2 Top & bottom rail colors	2 Top and bottom rail colors Mesh panel is stainless steel
CURVABLE ³	✓			
COCKTAIL RAIL ⁴	✓	✓		✓
COST	\$\$\$\$\$			
STYLE	MODERN			

TREX TRANSCEND® RAILING



	RAIL KITS	CUSTOM ROUTE
POSTS & RAILS	Composite	
INFILLS	Round aluminum balusters OR Square composite balusters	
AVAILABLE RAIL AND BALUSTER COLORS	3 Top and bottom rail colors & composite balusters 1 Aluminum round baluster color	4 Top and bottom rail colors & composite balusters 3 Aluminum balusters colors
CURVABLE ³	✓	✓
COCKTAIL RAIL ⁴	✓	✓
COST	\$\$\$	
STYLE	TRADITIONAL	

TREX SELECT® RAILING



	CLASSIC	T-RAIL
	RAIL KIT	
POSTS & RAILS	Aluminum	Composite
INFILLS	Round aluminum balusters	Square composite balusters or round composite balusters ⁵
AVAILABLE RAIL AND BALUSTER COLORS	1 Top and bottom rail color 1 Round aluminum baluster color	1 Top and bottom rail color 1 Round aluminum baluster color 1 Composite square baluster color
CURVABLE ³		
COCKTAIL RAIL ⁴	✓	
COST	\$\$	
STYLE	STANDARD	

¹Signature Aluminum railing with round aluminum balusters is only available in Charcoal Black. ²To complete your rail section, visit glass.trex.com. ³See trex.com for more information on curving Trex railing.

⁴A cocktail rail uses Trex Transcend or Select deck boards to turn your railing into an additional surface for drinks and more. All deck boards sold separately. Not compatible with Select T-Rail.

⁵Select Railing kits with square composite balusters are only offered with T-Rail configurations. Not compatible with Classic Select railing.



Order railing
for any deck
or porch

Customization
Options

Buying
Steps

SKU
Index



FIND A BUILDER



ORDERING HELP



DESIGN HELP

HOME





Trex Signature[®]
X-SERIES™ RAILING

The new Trex Signature X-Series Posts and Rail Kits have the most dynamic cable railing and frameless glass infill options in the category. Modular post and rail kit combinations make ordering and installation simple.

Where
to Shop



FIND A BUILDER



ORDERING HELP



DESIGN HELP

HOME



Product Options

Versatile X-Series™ Post can be configured to accommodate cable or frameless glass infill.

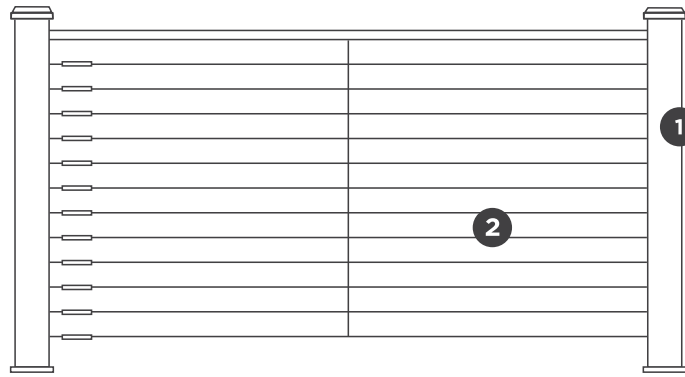

- 1 X-SERIES POST
- 2 CABLE RAIL KIT

CABLE INFILL

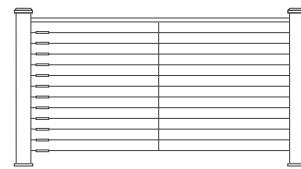

COLOR:



- 1 2



- 1 X-SERIES POST
- 2 FRAMELESS GLASS INFILL KIT
- 3 LAMINATED GLASS PANEL

GLASS INFILL

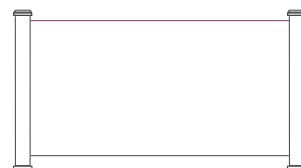

COLOR:



- 1 2 3



FIND A BUILDER



ORDERING HELP



DESIGN HELP

1 X-SERIES POST



Can be used as an end, line and corner post.

Heights
37", 43"
53"
Applications
Horizontal
Stair

2 CABLE RAIL KIT

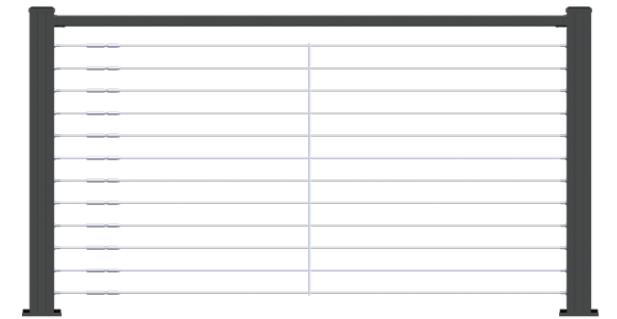

Heights
36", 42"
36", 42"
Lengths
6', 12', 18'
6'
Applications
Horizontal
Stair

BK

BK

2 FRAMELESS GLASS INFILL KIT

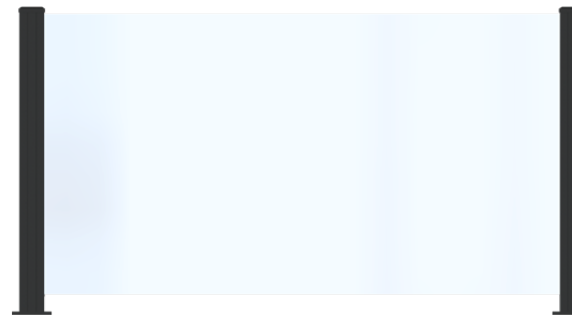

Heights
All (Cut to Length)
Applications
Horizontal

BK

3 LAMINATED GLASS PANEL*

Visit glass.trex.com to order custom glass panels to complete your build.



Additional Specs
36" (914 mm) high rail: 1/2" x 33" x 73.125" max.
(12.7 mm x 838 mm x 1857 mm)
42" (1067 mm) high rail: 1/2" x 39" x 73.125" max.
(12.7 mm x 991 mm x 1857 mm)

*SGP interlayer is recommended for laminated glass.

XX = COLOR PREFIX

BK Charcoal Black

PLEASE REFER TO SKU PAGES FOR ACTUAL DIMENSIONS.

HOME



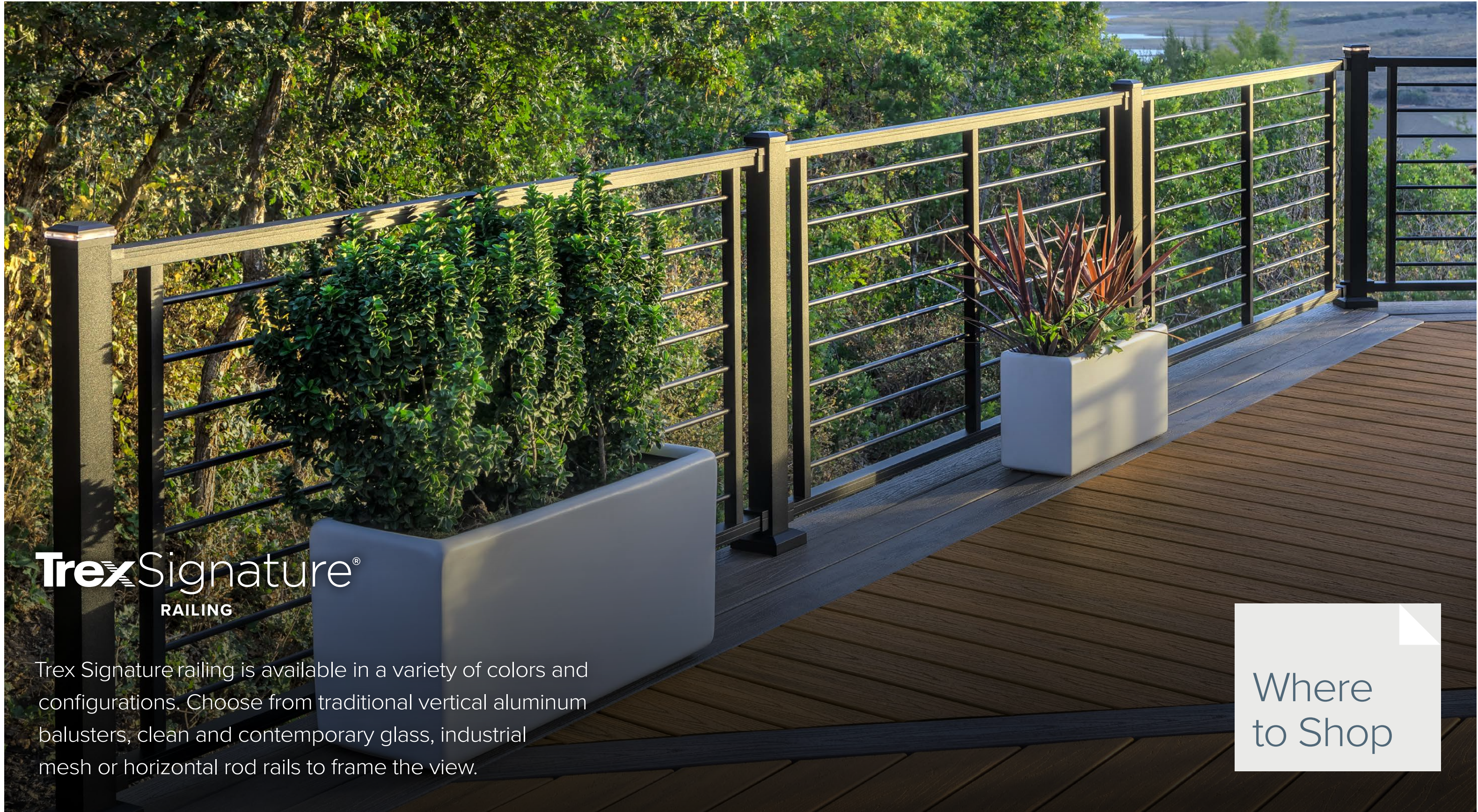

Trex Signature[®]

RAILING

Trex Signature railing is available in a variety of colors and configurations. Choose from traditional vertical aluminum balusters, clean and contemporary glass, industrial mesh or horizontal rod rails to frame the view.

Where
to Shop

TREX SIGNATURE® RAILING

LOOK A:
Aluminum Posts

Keep it consistent with aluminum posts and rails, available in three powder-coated colors.

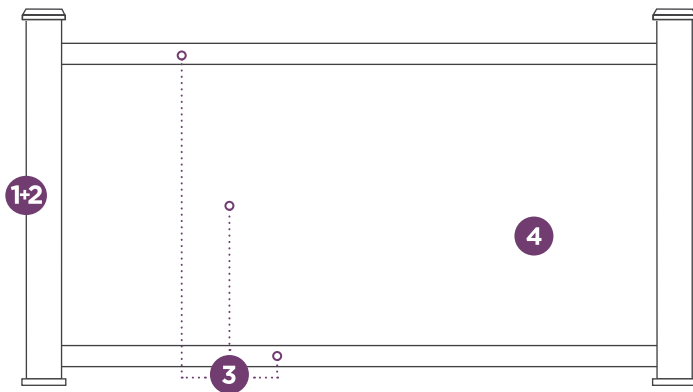

- 1+2** ALUMINUM POST + CAP & SKIRT
- 3** RAIL KIT: TOP RAIL, BOTTOM RAIL, INFILL
- 4** GLASS OR MESH INFILL PANEL

TREX SIGNATURE® RAILING

LOOK B:
Composite Post Sleeve

Create a mixed materials look with Trex Post Components and aluminum rails. The addition of composite allows for even more color combinations.

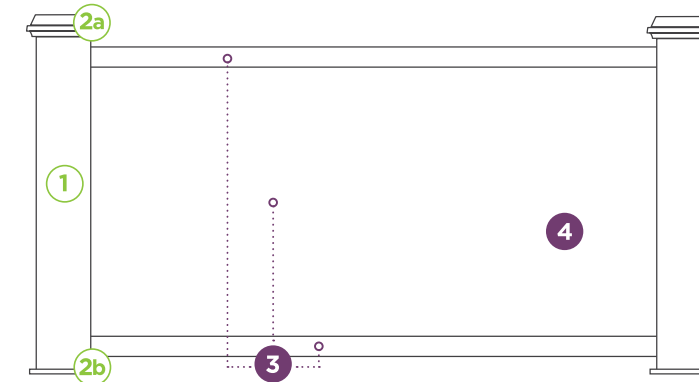

- 1** POST SLEEVE
- 2a** POST SLEEVE CAP
- 2b** POST SLEEVE SKIRT
- 3** RAIL KIT: TOP RAIL, BOTTOM RAIL, INFILL
- 4** GLASS OR MESH INFILL PANEL

ALUMINUM RAILING

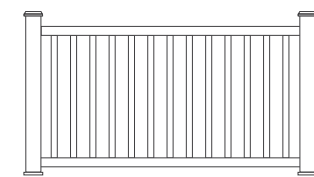

COLORS:

WT	BZ	BK
----	----	----

1+2 3

ROD RAIL

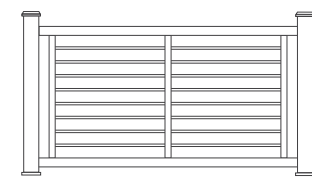

COLOR COMBINATIONS:

BK	BK
----	----

First color denotes rails; second color denotes infill.

1+2 3

ALUMINUM RAILING

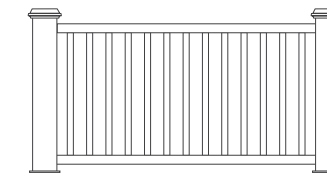

COLORS:

WT	BZ	BK
----	----	----

1 2a 2b 3

ROD RAIL

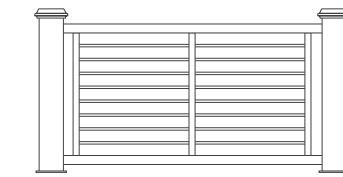

COLOR COMBINATIONS:

BK	BK
----	----

First color denotes rails; second color denotes infill.

1 2a 2b 3

GLASS RAILING

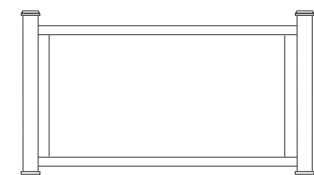

COLORS:

WT	BK
----	----

1+2 3 4

MESH RAILING

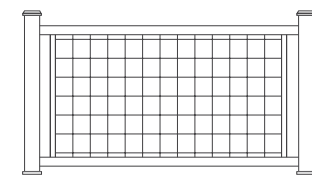

COLORS:

BZ	BK
----	----

Mesh is 316 mill-finish stainless steel.

SS

1+2 3 4

GLASS RAILING

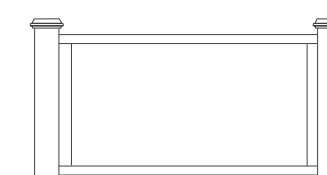

COLORS:

WT	BK
----	----

1 2a 2b 3 4

MESH RAILING

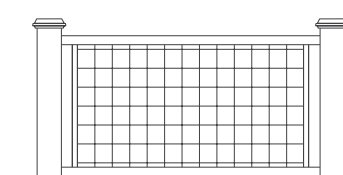

COLORS:

BZ	BK
----	----

Mesh is 316 mill-finish stainless steel.

SS

1 2a 2b 3 4

XX = COLOR PREFIX WT Classic White BZ Bronze
 BK Charcoal Black

PLEASE REFER TO SKU PAGES FOR ACTUAL DIMENSIONS.



Product Options

LOOK A:

Continue with Step 1+2 to pick your aluminum posts.



LOOK B:

Jump to Steps [1, 2a](#) (pg 38) and [2b](#) (pg 38) to pick your composite posts.



STEP 1+2: PICK AN ALUMINUM POST STYLE

1+2

ALUMINUM POST

Use for a traditional aluminum post look.

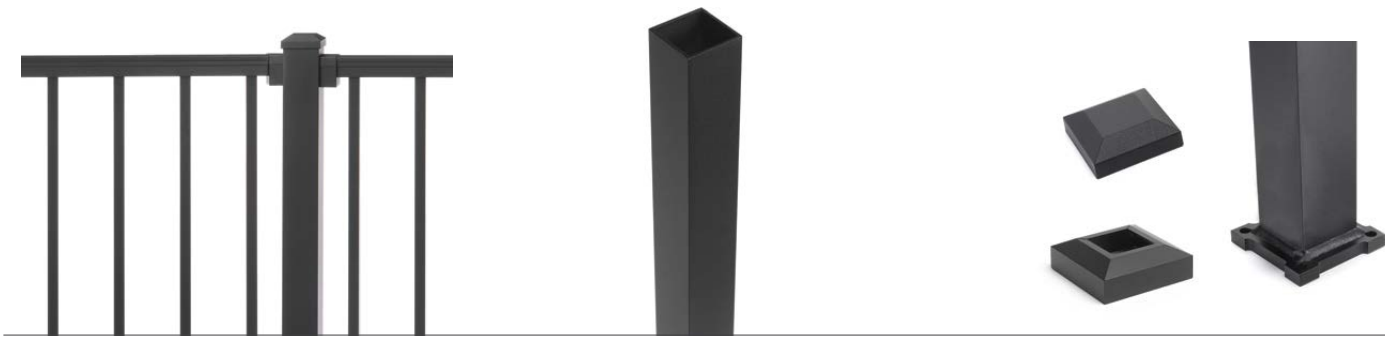

Heights
37", 43"
53"

Applications
Horizontal
Stair



1+2

ALUMINUM CROSSOVER POST

Use for a continuously graspable top rail.



Heights
36", 42"

Application
Horizontal*



*Stair crossover applications can only be achieved with the use of a swivel crossover bracket. See page 61 (item# XX25RCSWSCBKTL).

1+2

ALUMINUM JOIST MOUNT POST

Use with steel deck framing or wood framing.



Height
63"

Application
Horizontal



1+2

ALUMINUM POST WITH PREMOUNTED BRACKETS

Use for simple and quick post applications.



Heights
37", 43"

Application
Horizontal

Brackets
Line, End, Corner



SIMPLIFY STEP 3

by choosing assembled square baluster panels, shown on [page 39](#).



XX = COLOR PREFIX

WT Classic White
BK Charcoal Black

BZ Bronze

PLEASE REFER TO SKU PAGES FOR ACTUAL DIMENSIONS.



FIND A BUILDER



ORDERING HELP



DESIGN HELP

HOME



STEPS 1, 2A, 2B: PICK A COMPOSITE POST STYLE

1

POST SLEEVE

Each 4" x 4" and 6" x 6" post sleeve fits over a 4" x 4" pressure treated post or equivalent post mount.

6" x 6" width only available in Classic White.



Heights	Widths
39", 108"	4" x 4", 6" x 6"



2a

POST SLEEVE CAP

6" x 6" width only available in Classic White.



Widths
4" x 4", 6" x 6"



DESIGN CHECK

Opt for a post cap light variation. Details on [page 69](#).



2b

POST SLEEVE SKIRT

6" x 6" width only available in Classic White.

4" x 4" is 2 piece and 6" x 6" is 1 piece.



Widths
4" x 4", 6" x 6"



STEP 3: GO WITH A RAIL KIT

3

ALUMINUM RAIL & SQUARE BALUSTER KIT



Heights	Lengths	Applications
36", 42"	6', 8'	Horizontal, Stair



3

ALUMINUM RAIL & ROUND BALUSTER KIT



Heights	Lengths	Applications
36", 42"	6', 8'	Horizontal, Stair



3

ASSEMBLED SQUARE BALUSTER PANEL

Use for simple and quick rail applications. Brackets sold separately.

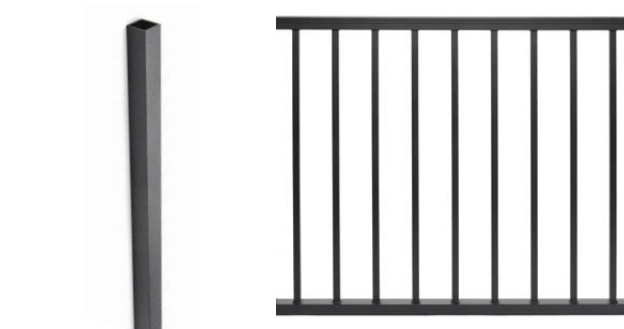

Heights	Lengths	Applications
36", 42"	4', 6', 8' 6', 8'	Horizontal, Stair



FIND A BUILDER



ORDERING HELP



DESIGN HELP

XX = COLOR PREFIX

WT Classic White
BK Charcoal Black

RS Rope Swing
VL Vintage Lantern

PLEASE REFER TO SKU PAGES FOR ACTUAL DIMENSIONS.

HOME



3 ROD RAIL KIT

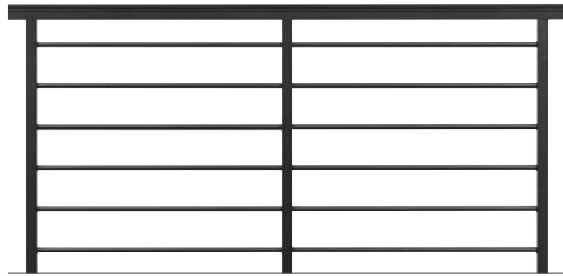

Heights	Lengths	Applications
36", 42"	6', 8'	Horizontal, Stair

First color denotes rails; second color denotes infill. **BK** **BK**

3 MESH RAIL KIT

Mesh infill sold separately. Continue to Step 4 to complete your build.

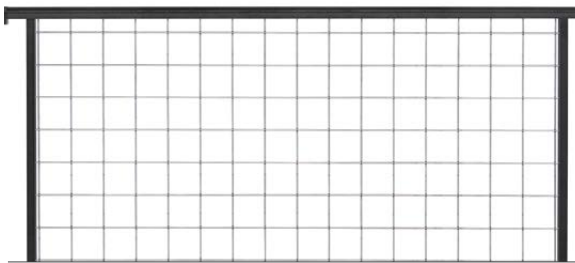

Heights	Lengths	Applications
36", 42"	6', 8'	Horizontal, Stair

BZ **BK**

3 GLASS RAIL KIT

Glass infill sold separately. Continue to Step 4 to complete your build.

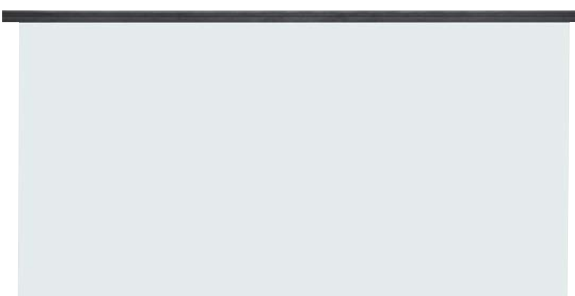

Length	Application
6'	Horizontal

WT **BK**

STEP 4: MESH, CABLE & GLASS INFILL PANELS

4 MESH INFILL PANEL

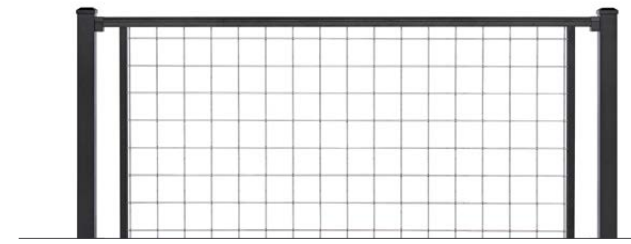

Heights	Lengths	Applications
36", 42"	6', 8'	Horizontal, Stair

4 GLASS INFILL PANEL

Visit glass.trex.com to order custom glass panels to complete your build.

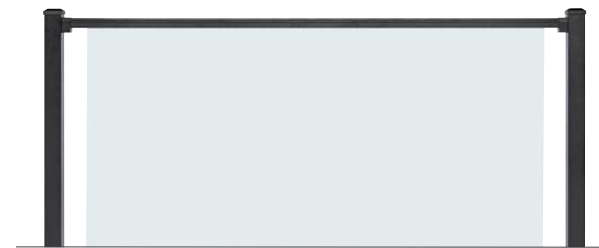

Additional Specs

36" (914 mm) high rail: 1/4" x 32-5/16" x 67" max. (6 mm x 821 mm x 1702 mm)
 42" (1067 mm) high rail: 1/4" x 38-5/16" x 67" max. (6 mm x 973 mm x 1702 mm)

Want an additional surface for drinks and more?

Add a cocktail rail using a solid core deck board. For installation, see cocktail rail bracket on [page 60](#).

Not compatible with Signature Glass Railing.



FIND A BUILDER



ORDERING HELP



DESIGN HELP

XX = COLOR PREFIX

WT Classic White
BK Charcoal Black

BZ Bronze

PLEASE REFER TO SKU PAGES FOR ACTUAL DIMENSIONS.

HOME





Trex Transcend®
RAILING

No other Trex railing line offers the freedom to mix and match infill and rails like Trex Transcend. Transcend puts every color combination within reach. Get style-specific or eliminate the guesswork with pre-designed kits.

Where
to Shop

TRADITIONAL STYLE SIMPLIFIED:
Railing Kits & Systems

A Transcend rail kit includes composite top and bottom rails and your choice of square composite or round aluminum balusters.



FEWER STEPS IN SELECTION AND ORDERING PROCESSES

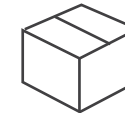

RAILING COMPONENTRY ALL IN ONE BOX*



PRE-DESIGNED IN OUR MOST POPULAR LOOKS

KIT 1:
COMPOSITE RAIL & SQUARE
COMPOSITE BALUSTERS



KIT 2:
COMPOSITE RAIL & SQUARE
COMPOSITE BALUSTERS



KIT 3:
COCKTAIL RAIL & ROUND
ALUMINUM BALUSTER

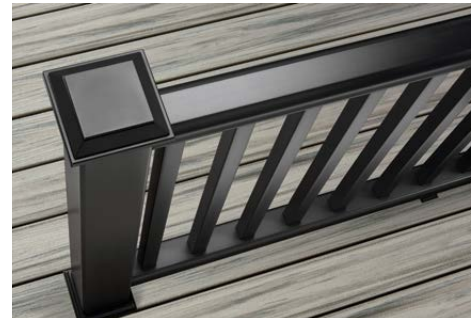

A cocktail rail kit allows for a solid core decking board to be installed on top of a Universal top/bottom rail, creating the perfect flat surface for beverages and more.

Cocktail rail kits only available with rails in WT with round aluminum balusters in BK.

*Post sleeve, cap and skirt sold separately.
**All deck boards sold separately.



FIND A BUILDER



ORDERING HELP



DESIGN HELP

HOME



TREX TRANSCEND® RAILING

LOOK A:
Rail Kit

Available in our most popular composite hues, a Transcend kit simplifies decision making.

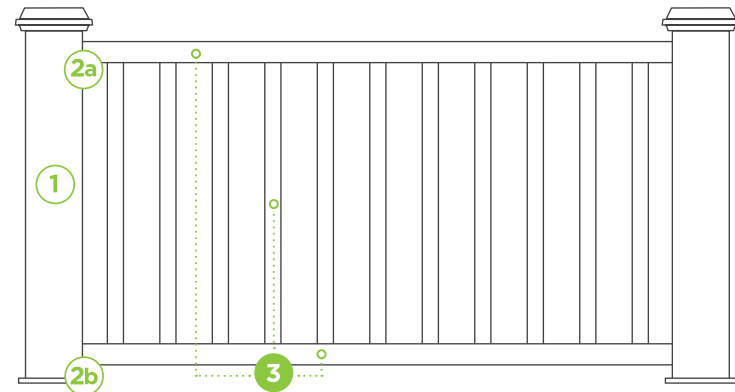

- 1 POST SLEEVE
- 2a POST SLEEVE CAP
- 2b POST SLEEVE SKIRT
- 3 RAIL KIT: TOP RAIL, BOTTOM RAIL, BALUSTERS

TREX TRANSCEND® RAILING

LOOK B:
Custom Build

To choose from our full suite of colors and additional baluster options, go custom.

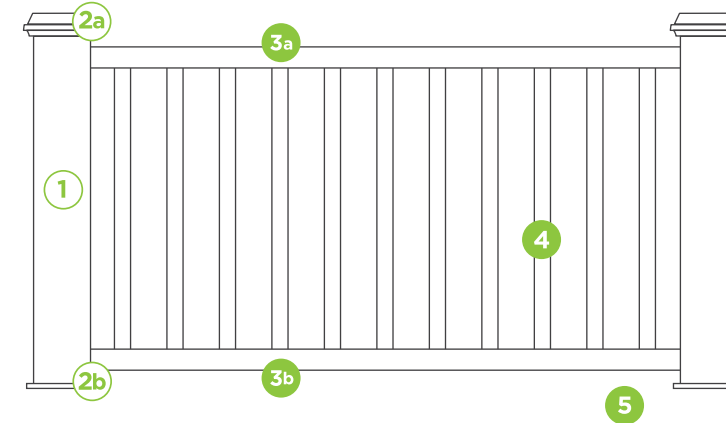

- 1 POST SLEEVE
- 2a POST SLEEVE CAP
- 2b POST SLEEVE SKIRT
- 3a TOP RAIL
- 3b BOTTOM RAIL
- 4 BALUSTERS
- 5 ACCESSORY INFILL KIT

3 RAIL & BALUSTER KIT

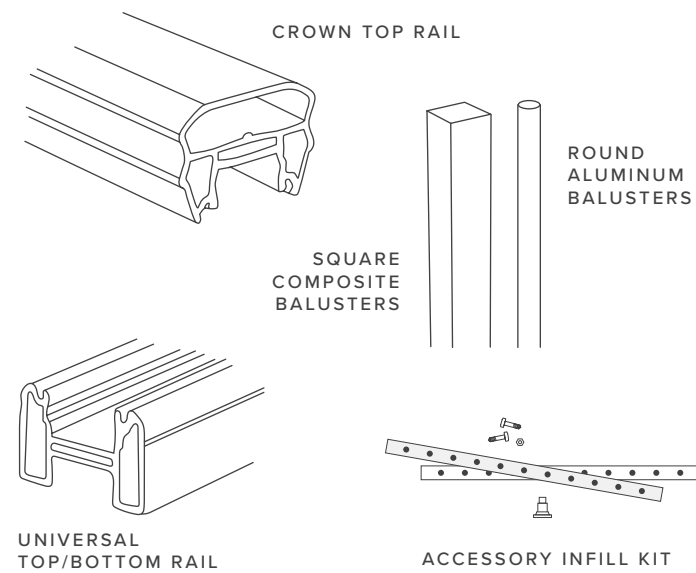

- RAIL & BALUSTER KIT COLORS:
- WT Composite
 - BK Composite
 - VL Composite
 - BK Aluminum

3 COCKTAIL RAIL & BALUSTER KIT

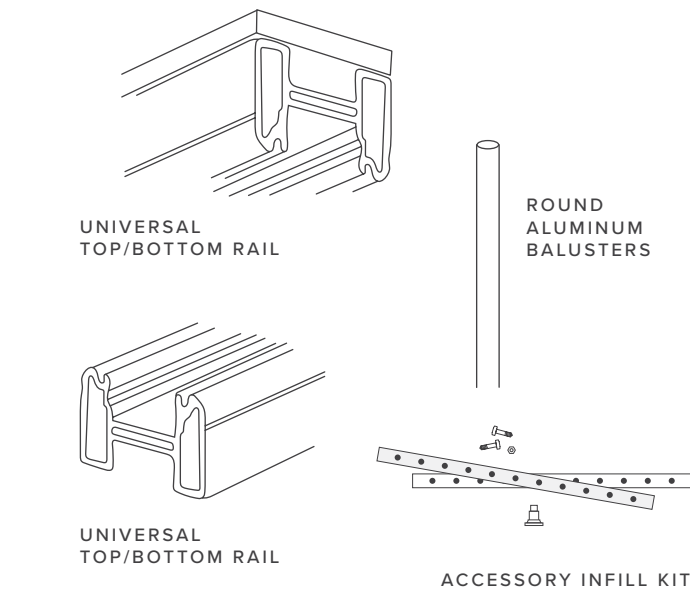

- COCKTAIL RAIL & BALUSTER KIT COLORS:
- WT Composite
 - BK Aluminum

3a

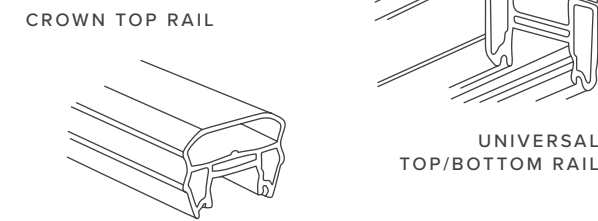

3b

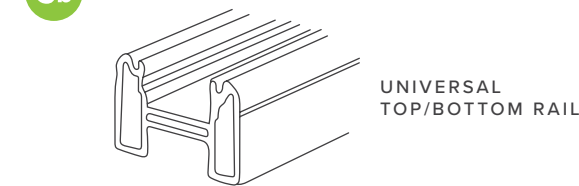

- CUSTOM COLORS:
- WT Composite
 - BK Composite
 - RS Composite
 - VL Composite

4

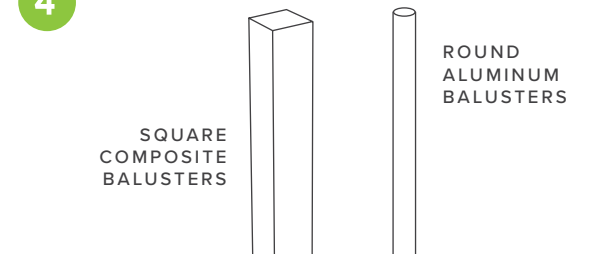

5

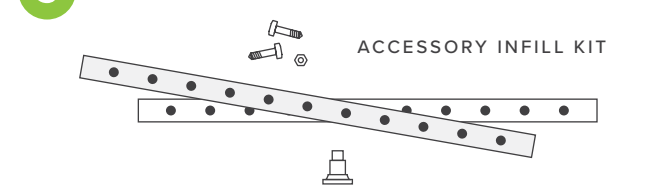

- ALUMINUM:
- WT Aluminum
 - BZ Aluminum
 - BK Aluminum

Product Options

STEPS 1, 2A, 2B: PICK A POST STYLE

1 POST SLEEVE
 Each 4" x 4" and 6" x 6" post sleeve fits over a 4" x 4" pressure treated post or equivalent post mount.
 6" x 6" width only available in Classic White.



Heights
39", 108"

Widths
4" x 4", 6" x 6"



2a POST SLEEVE CAP
 6" x 6" width only available in Classic White.



Widths
4" x 4", 6" x 6"



DESIGN CHECK

Opt for a post cap light variation.
 Details on [page 69](#).



2b POST SLEEVE SKIRT
 6" x 6" width only available in Classic White.
 4" x 4" is 2 piece and 6" x 6" is 1 piece.



Widths
4" x 4", 6" x 6"



LOOK A:
 Simply continue with Step 3 to complete your kit look.



LOOK B:
 Jump to Steps [3a](#) and [3b](#) on the next page to build your custom look.



STEP 3: GO WITH A RAIL KIT

3 RAIL & SQUARE COMPOSITE BALUSTER KIT
 Use for simplified, pre-designed rail applications.



Heights
36", 42"

Lengths
6', 8'
(72", 96")

Applications
Horizontal, Stair



3 RAIL & ROUND ALUMINUM BALUSTER KIT
 Use for simplified, pre-designed rail applications.



Heights
36", 42"

Lengths
6', 8'
(72", 96")

Applications
Horizontal, Stair



3 COCKTAIL RAIL & ROUND ALUMINUM BALUSTER KIT
 Use for simplified, pre-designed rail applications. Only Trex Transcend and Select deck boards can be used for cocktail rail applications. Boards sold separately.



Heights
36"

Lengths
6', 8'
(72", 96")

Applications
Horizontal, Stair



XX = COLOR PREFIX

WT Classic White
 BK Charcoal Black

BZ Bronze
 RS Rope Swing

VL Vintage Lantern

PLEASE REFER TO SKU PAGES FOR ACTUAL DIMENSIONS.

STEP 3A: PICK A TOP RAIL

3a CROWN TOP RAIL



Lengths
6', 8'
(72", 96")



3a UNIVERSAL TOP/BOTTOM RAIL

Use for cocktail rail applications.



Lengths
6', 8'
(72", 96")



STEP 3B: PICK A BOTTOM RAIL

3b UNIVERSAL TOP/BOTTOM RAIL



Lengths
6', 8'
(72", 96")



STEP 4: CHOOSE AN INFILL

4 SQUARE COMPOSITE BALUSTERS



Heights
36", 42"

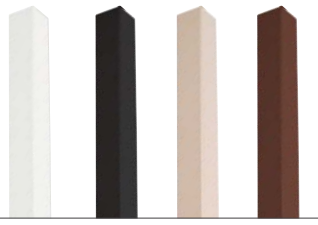

4 ROUND ALUMINUM BALUSTERS



Heights
36", 42"

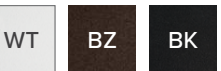

STEP 5: SELECT AN ACCESSORY INFILL KIT

5 SQUARE COMPOSITE BALUSTER INFILL KIT

Use this hardware to assemble a railing section consisting of square composite balusters.



Lengths
6', 8'

Applications
Horizontal, Stair



5 ROUND ALUMINUM BALUSTER INFILL KIT

Use this hardware to assemble a railing section consisting of round aluminum balusters.



Lengths
6', 8'

Applications
Horizontal, Stair



FIND A BUILDER



ORDERING HELP



DESIGN HELP

XX = COLOR PREFIX

WT Classic White
BK Charcoal Black

BZ Bronze
RS Rope Swing

VL Vintage Lantern

PLEASE REFER TO SKU PAGES FOR ACTUAL DIMENSIONS.

HOME



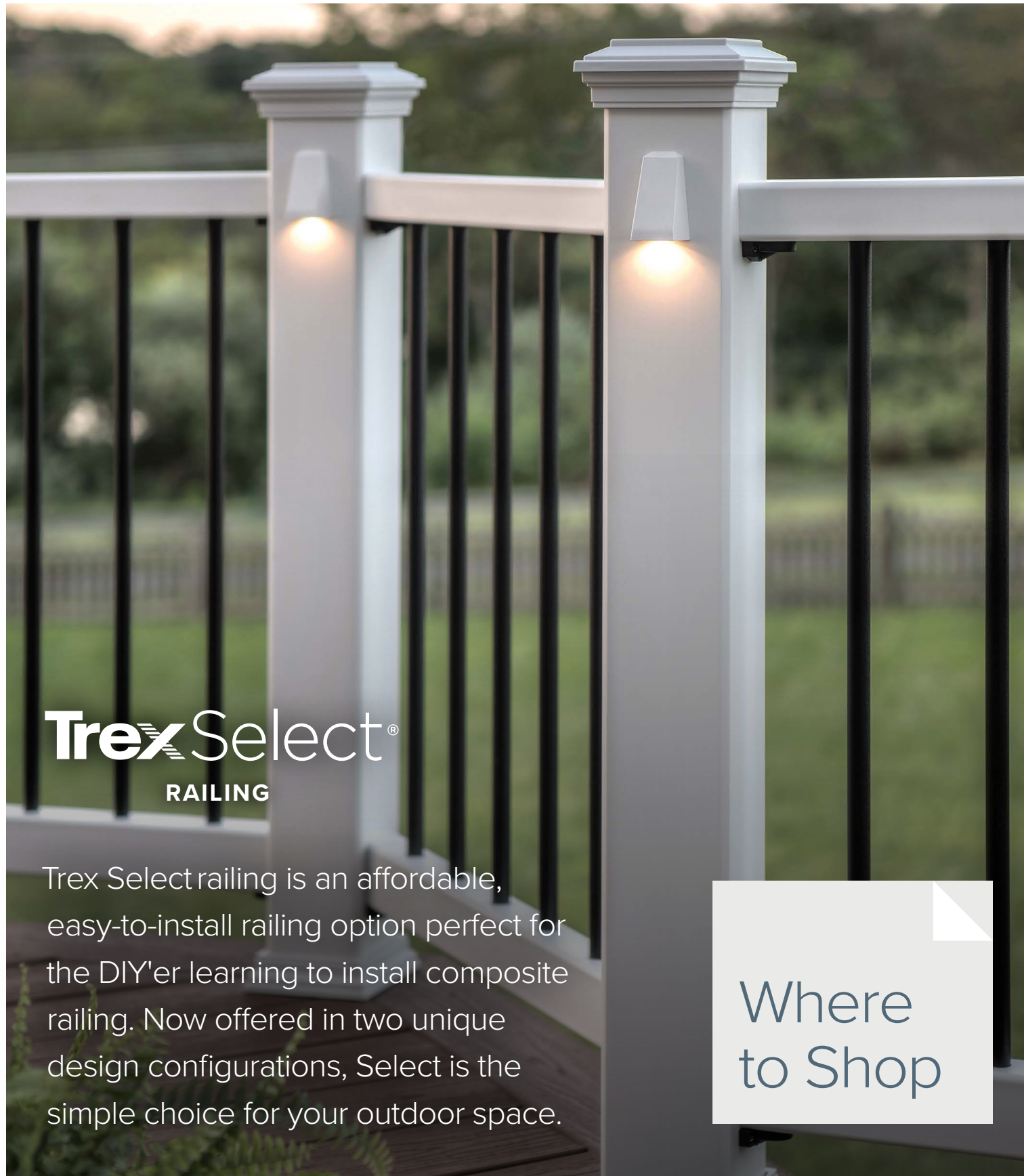

Trex Select[®]
RAILING

Trex Select railing is an affordable, easy-to-install railing option perfect for the DIY'er learning to install composite railing. Now offered in two unique design configurations, Select is the simple choice for your outdoor space.

Where
to Shop



FIND A BUILDER



ORDERING HELP



DESIGN HELP

TREX SELECT[®] RAILING

The Standard Look

Trex Select Classic and T-Rail offer two top rail looks in one neutral color—Classic White. Simply choose your preferred top rail design.

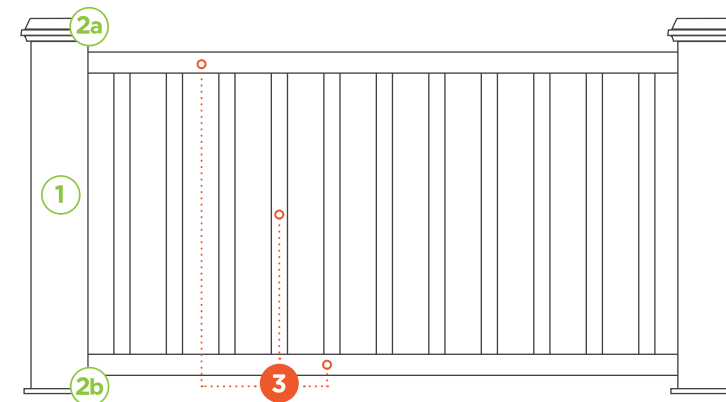

- 1** POST SLEEVE
- 2a** POST SLEEVE CAP
- 2b** POST SLEEVE SKIRT
- 3** RAIL KIT: TOP RAIL, BOTTOM RAIL, INFILL

3 CLASSIC RAIL & BALUSTER KIT

COMPOSITE CLASSIC TOP RAIL

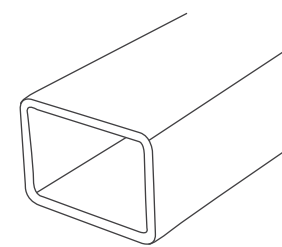

COMPOSITE BOTTOM RAIL

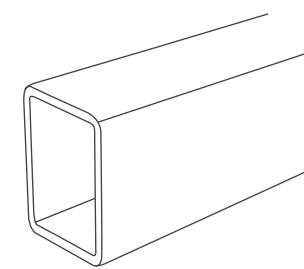

ROUND ALUMINUM BALUSTERS



MOUNTING HARDWARE

CLASSIC RAIL & BALUSTER KIT COLORS:



Composite Aluminum

3 T-RAIL & BALUSTER KIT

COMPOSITE T TOP RAIL

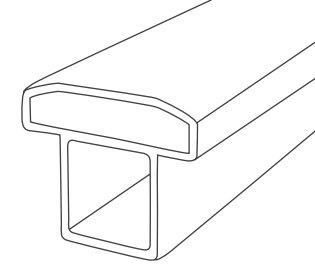

COMPOSITE BOTTOM RAIL

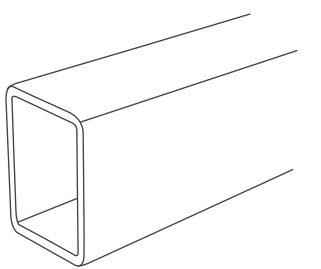

SQUARE COMPOSITE BALUSTERS

ROUND ALUMINUM BALUSTERS



MOUNTING HARDWARE

T-RAIL & BALUSTER KIT COLORS:



Composite Aluminum

XX = COLOR PREFIX

WT Classic White
BK Charcoal Black

PLEASE REFER TO SKU PAGES FOR ACTUAL DIMENSIONS.

HOME



Product Options

STEPS 1, 2A, 2B: PICK YOUR POST

1 POST SLEEVE
 Each 4" x 4" and 6" x 6" post sleeve fits over a 4" x 4" pressure treated post or equivalent post mount.
 6" x 6" width only available in Classic White.



Heights	Widths
39", 108"	4" x 4", 6" x 6"

WT

2a POST SLEEVE CAP
 6" x 6" width only available in Classic White.



Widths
4" x 4", 6" x 6"

WT

2b POST SLEEVE SKIRT
 6" x 6" width only available in Classic White.
 4" x 4" is 2 piece, 6" x 6" is 1 piece.



Widths
4" x 4", 6" x 6"

WT

DESIGN CHECK
 Opt for a post cap light variation.
 Details on [page 69](#).



STEP 3: GO WITH A RAIL KIT

3 CLASSIC RAIL & ROUND ALUMINUM BALUSTER KIT
 Use for simplified, pre-designed rail applications.

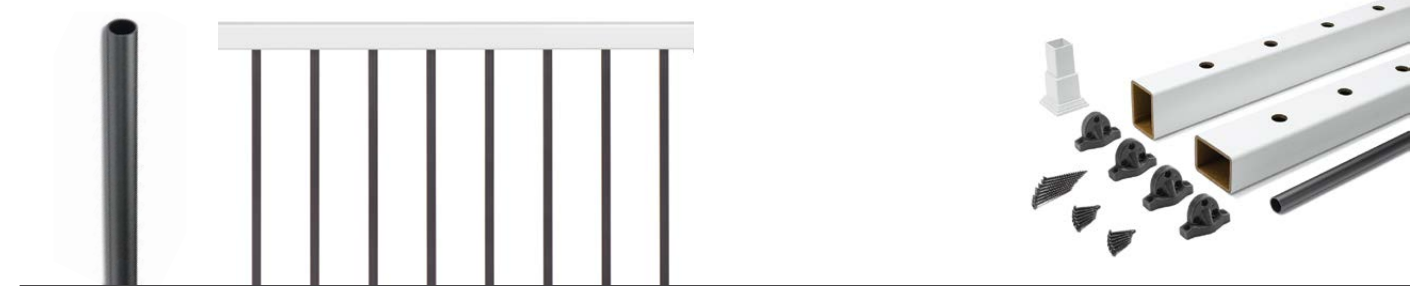

Heights	Lengths	Applications
36", 42"	6', 8' (72", 96")	Horizontal, Stair

WT

3 T-RAIL & ROUND ALUMINUM BALUSTER KIT
 Use for simplified, pre-designed rail applications.



Heights	Lengths	Applications
36", 42"	6', 8' (72", 96")	Horizontal, Stair

WT

3 T-RAIL & SQUARE COMPOSITE BALUSTER KIT
 Use for simplified, pre-designed rail applications.

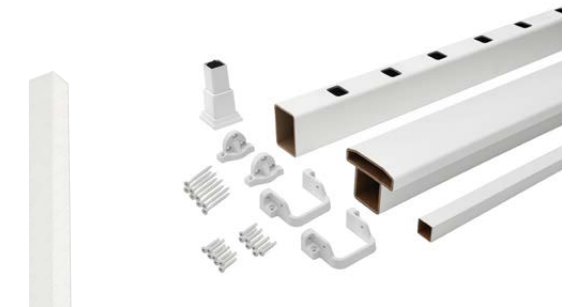

Heights	Lengths	Applications
36", 42"	6', 8' (72", 96")	Horizontal, Stair

WT

XX = COLOR PREFIX
 WT Classic White
 BK Charcoal Black
 PLEASE REFER TO SKU PAGES FOR ACTUAL DIMENSIONS.

Product SKUs

TREX® POST SLEEVES, CAPS & SKIRTS

These components can be used as steps 1 & 2 for all Trex railing lines except Signature X-Series.

1 POST SLEEVE

COMPONENT	DIMENSIONS	ITEM #	COLORS
Post Sleeve Includes 1 post sleeve cap. Each 4x4 and 6x6 post sleeve fits over a 4x4 pressure treated post or equivalent post mount.	4" x 4" x 39" Composite Post Sleeve <i>Actual external dimensions: 4.45 in x 4.45 in x 40 in (113 mm x 113 mm x 101 cm)</i>	XX040439APS	WT BK RS VL
	4" x 4" x 108" Composite Post Sleeve <i>Actual external dimensions: 4.45 in x 4.45 in x 108 in (113 mm x 113 mm x 274 cm)</i>	XX0404108APS	
	6" x 6" x 39" Composite Post Sleeve <i>Actual external dimensions: 5.5 in x 5.5 in x 39 in (139 mm x 139 mm x 990 mm)</i>	WT060639APS	WT
	6" x 6" x 108" Composite Post Sleeve <i>Actual external dimensions: 5.5 in x 5.5 in x 108 in (139 mm x 139 mm x 274 cm)</i>	WT0606108APS	



2a POST SLEEVE CAP

COMPONENT	DIMENSIONS	ITEM #	COLORS
Post Sleeve Cap Includes 1 post sleeve cap. Also available with LED lighting. See page 69.	Flat 4" x 4" Composite Post Sleeve Cap <i>Actual internal dimensions: 4.55 in x 4.55 in (115 mm x 115 mm)</i>	PXXSQCAP4X4	WT BK RS VL
	Flat 6" x 6" Composite Post Sleeve Cap <i>Actual internal dimensions: 5.55 in x 5.55 in (140 mm x 140 mm)</i>	PWTSQCAP6X6	



XX = COLOR PREFIX



WT Classic White
BK Charcoal Black
RS Rope Swing
VL Vintage Lantern

2b POST SLEEVE SKIRT

COMPONENT	DIMENSIONS	ITEM #	COLORS
Post Sleeve Skirt Includes 1 post sleeve skirt.	4" x 4" Composite Post Sleeve Skirt . 4" x 4" is 2 piece <i>Actual internal dimensions: 4.55 in x 4.55 in (115 mm x 115 mm)</i>	PXXSKIRT4X4	WT BK RS VL
	6" x 6" Composite Post Sleeve Skirt 6" x 6" is 1 piece, WT only <i>Actual internal dimensions: 5.55 in x 5.55 in (140 mm x 140 mm)</i>	PWTSKIRT6X6	WT



ACCESSORIES

COMPONENT	DESCRIPTION	ITEM #	COLORS
Aluminum Surface Mount Post Includes 2 aluminum inserts with set screws and (1) 2.5" IRC-compliant aluminum post with base. Mounting hardware sold separately.	 The Surface Mount Post is an alternative to a traditional wood post under the post sleeve. It is designed to be used on either decks or concrete surfaces. Actual external dimensions of insert: 3.75 in x 3.75 in x 7 in (95 mm x 95 mm x 177 mm)	ALPOSTMOUNT36	n/a
		ALPOSTMOUNT42	
Aluminum Surface Mount Post Hardware Includes hardware for 2.5" Trex Signature surface mount posts, 1 aluminum backer plate, 4 HG carriage bolts and 4 HG washers and nuts.	 Designed specifically to connect the 36" or 42" Trex Surface Mount Post to a wood substructure.	ALPOSTHWDECK	n/a
Aluminum Joist Mount Post Includes (1) 63" aluminum post (cut-to-length), 2 aluminum inserts with set screws, (2) 1/2" HG bolts, washers and nuts, 1 bolt spacing template and (16) 316 SS screws.	 For use with all Trex railing heights and 4" x 4" post sleeves. Actual external dimensions of insert: 3.75 in x 3.75 in x 7 in (95 mm x 95 mm x 177 mm)	CPJMNTPOST63	n/a

CONSULT YOUR LOCAL BUILDING DEPARTMENT FOR PROJECT DESIGN AND MATERIAL SPECIFICATION REVIEW.



FIND A BUILDER



ORDERING HELP



DESIGN HELP

HOME



1 X-SERIES™ POST Versatile X-Series Post can be configured to accommodate cable or frameless glass infill.

COMPONENT	ORIENTATION	DIMENSIONS	ITEM #	COLOR
X-Series Post For use with Trex Signature® X-Series™ Cable or Frameless Glass Can be used as an end, line and corner post.	Horizontal	3.5" x 3.5" x 37" Anchor Post	BKAX353537RCAP	BK
		3.5" x 3.5" x 43" Anchor Post	BKAX353543RCAP	
	Stair	3.5" x 3.5" x 53" Anchor Post	BKAX353553RCAP	

2+3 X-SERIES™ RAILING

COMPONENT	ORIENTATION	DIMENSIONS	ITEM #	COLOR
Cable Rail Kit Dimensions are nominals. See below for actuals and metrics. <i>[6' x 36": 72 in x 36 in (182 cm x 914 mm) actual dimensions]</i> <i>[12' x 36": 144 in x 36 in (365 cm x 914 mm) actual dimensions]</i> <i>[18' x 36": 216 in x 36 in (548 cm x 914 mm) actual dimensions]</i> <i>[6' x 42": 72 in x 42 in (182 cm x 106 cm) actual dimensions]</i> <i>[12' x 42": 144 in x 42 in (365 cm x 106 cm) actual dimensions]</i> <i>[18' x 42": 216 in x 42 in (548 cm x 106 cm) actual dimensions]</i>	Horizontal	6' x 36" Cable Rail Kit	BKAX0636CBLHRK	BK
		12' x 36" Cable Rail Kit	BKAX1236CBLHRK	
		18' x 36" Cable Rail Kit	BKAX1836CBLHRK	
		6' x 42" Cable Rail Kit	BKAX0642CBLHRK	
		12' x 42" Cable Rail Kit	BKAX1242CBLHRK	
		18' x 42" Cable Rail Kit	BKAX1842CBLHRK	
	Stair	6' x 36" Cable Rail Kit	BKAX0636CBLSRK	
		6' x 42" Cable Rail Kit	BKAX0642CBLSRK	
Frameless Glass Infill Kit	Horizontal	One-Size Infill Kit	BKAXGLIK	BK
Laminated Glass Panel For use with Trex Signature® X-Series™ Frameless Glass Infill Kit	Horizontal	for 36" Rail Height for 42" Rail Height	Visit glass.trex.com to order custom glass panels to complete your build	

COMPONENT	ORIENTATION	DESCRIPTION	ITEM #	COLOR
Compound Swivel Bracket 1 per pack (top rail only)	Horizontal / Stair	Use for angled applications. Included in stair rail kits. Sold separately for horizontal applications.	BKAXCPDSWBKT	BK

1+2 POSTS, CAPS & SKIRTS

COMPONENT	ORIENTATION	DIMENSIONS	ITEM #	COLORS
Aluminum Post Includes post, cap and skirt.	Horizontal	2.5" x 2.5" x 37" Post	XXAL252537RCAP	WT BZ BK
		2.5" x 2.5" x 43" Post	XXAL252543RCAP	
	Stair	2.5" x 2.5" x 53" Post	XXAL252553RCAP	
Aluminum Crossover Post Includes post with pre-mounted crossover bracket and skirt.	Horizontal	2.5" x 2.5" x 36" Crossover Post	XXAL252536RCCP	WT BZ BK
		2.5" x 2.5" x 42" Crossover Post	XXAL252542RCCP	
Aluminum Joist Mount Post Includes post, cap, skirt, hardware and spacing template. For use with steel deck framing or wood framing.	Horizontal	2.5" x 2.5" x 63" Joist Mount Post	XXJMNTPOST63	WT BZ BK

1+2 POSTS, CAPS & SKIRTS (continued)

COMPONENT	ORIENTATION	DIMENSIONS	ITEM #	COLORS
Aluminum Post with Pre-mounted Brackets Includes post with pre-mounted brackets, cap and skirt.	Line	2.5" x 2.5" x 37" Post with Brackets	BKAL252537RCAPLINE	BK
		2.5" x 2.5" x 43" Post with Brackets	BKAL252543RCAPLINE	
	End	2.5" x 2.5" x 37" Post with Brackets	BKAL252537RCAPEND	
		2.5" x 2.5" x 43" Post with Brackets	BKAL252543RCAPEND	
	Corner	2.5" x 2.5" x 37" Post with Brackets	BKAL252537RCAPCNR	
		2.5" x 2.5" x 43" Post with Brackets	BKAL252543RCAPCNR	

Dimensions above are nominals. See below for actuals and metrics.

<i>2.5 in x 2.5 in x 36 in (63 mm x 63 mm x 914 mm)</i>	<i>2.5 in x 2.5 in x 43 in (63 mm x 63 mm x 109 cm)</i>
<i>2.5 in x 2.5 in x 37 in (63 mm x 63 mm x 939 mm)</i>	<i>2.5 in x 2.5 in x 53 in (63 mm x 63 mm x 134 cm)</i>
<i>2.5 in x 2.5 in x 42 in (63 mm x 63 mm x 106 cm)</i>	<i>2.5 in x 2.5 in x 63 in (63 mm x 63 mm x 160 cm)</i>

3 RAIL KITS

COMPONENT	ORIENTATION	DIMENSIONS	ITEM #	COLORS
Aluminum Rail & Square Baluster Kit Includes top rail, bottom rail, balusters and mounting and support hardware.	Horizontal	6' x 36" Rail & Baluster Kit	XXAS0636HRK	WT BZ BK
		8' x 36" Rail & Baluster Kit	XXAS0836HRK	
		6' x 42" Rail & Baluster Kit	XXAS0642HRK	
	Stair	8' x 42" Rail & Baluster Kit	XXAS0842HRK	
		6' x 36" Rail & Baluster Kit	XXAS0636SRK	
		8' x 36" Rail & Baluster Kit	XXAS0836SRK	
Aluminum Rail & Round Baluster Kit Includes top rail, bottom rail, balusters and mounting and support hardware.	Horizontal	6' x 36" Rail & Baluster Kit	BKAR0636HRK	BK
		8' x 36" Rail & Baluster Kit	BKAR0836HRK	
		6' x 42" Rail & Baluster Kit	BKAR0642HRK	
	Stair	8' x 42" Rail & Baluster Kit	BKAR0842HRK	
		6' x 36" Rail & Baluster Kit	BKAR0636SRK	
		8' x 36" Rail & Baluster Kit	BKAR0836SRK	
		6' x 42" Rail & Baluster Kit	BKAR0642SRK	
		8' x 42" Rail & Baluster Kit	BKAR0842SRK	

Dimensions above are nominals. See below for actuals and metrics.

<i>4' x 36": 48 in x 36 in (122 cm x 914 mm)</i>	<i>6' x 36": 72 in x 36 in (182 cm x 914 mm)</i>
<i>4' x 42": 48 in x 42 in (122 cm x 106 cm)</i>	<i>6' x 42": 72 in x 42 in (182 cm x 106 cm)</i>



FIND A BUILDER



ORDERING HELP



DESIGN HELP

XX = COLOR PREFIX

WT Classic White BZ Bronze
BK Charcoal Black

HOME



3 RAIL KITS (continued)

COMPONENT	ORIENTATION	DIMENSIONS	ITEM #	COLOR
Aluminum Assembled Square Baluster Panel Includes a preassembled panel of railing with square balusters. Mounting hardware sold separately.	Horizontal	4' x 36" Assembled Panel	BKAS0436HRPNL	BK
		6' x 36" Assembled Panel	BKAS0636HRPNL	
		8' x 36" Assembled Panel	BKAS0836HRPNL	
		4' x 42" Assembled Panel	BKAS0442HRPNL	
		6' x 42" Assembled Panel	BKAS0642HRPNL	
		8' x 42" Assembled Panel	BKAS0842HRPNL	
	Stair	6' x 36" Assembled Stair Panel	BKAS0636SRPNL	
		6' x 42" Assembled Stair Panel	BKAS0642SRPNL	
		8' x 36" Assembled Stair Panel	BKAS0836SRPNL	
		8' x 42" Assembled Stair Panel	BKAS0842SRPNL	

Dimensions above are nominals. See below for actuals and metrics.

4' x 36": 48 in x 36 in (122 cm x 914 mm)
 4' x 42": 48 in x 42 in (122 cm x 106 cm)

6' x 36": 72 in x 36 in (182 cm x 914 mm)
 6' x 42": 72 in x 42 in (182 cm x 106 cm)

COMPONENT	ORIENTATION	DIMENSIONS	ITEM #	COLORS
Rod Rail Kit Includes top rail, bottom rail, rods and mounting and support hardware.	Horizontal	6' x 36" Rod Rail Kit	XXXXROD0636HRK	BKBK
		8' x 36" Rod Rail Kit	XXXXROD0836HRK	
		6' x 42" Rod Rail Kit	XXXXROD0642HRK	
		8' x 42" Rod Rail Kit	XXXXROD0842HRK	
	Stair	6' x 36" Rod Rail Kit	XXXXROD0636SRK	
		8' x 36" Rod Rail Kit	XXXXROD0836SRK	

First color denotes rails; second color denotes infill.

COMPONENT	ORIENTATION	DIMENSIONS	ITEM #	COLOR
Mesh Rail Kit Includes top rail, bottom rail, verticals, and mounting and support hardware. Mesh infill sold separately.	Horizontal	6' x 36" Mesh Railing Kit	XXA0636PNLHRK	BZ BK
		8' x 36" Mesh Railing Kit	XXA0836PNLHRK	
		6' x 42" Mesh Railing Kit	XXA0642PNLHRK	
		8' x 42" Mesh Railing Kit	XXA0842PNLHRK	
	Stair	6' x 36" Mesh Railing Kit	XXA0636PNLSRK	
		8' x 36" Mesh Railing Kit	XXA0836PNLSRK	
		6' x 42" Mesh Railing Kit	XXA0642PNLSRK	
		8' x 42" Mesh Railing Kit	XXA0842PNLSRK	

Dimensions above are nominals. See below for actuals and metrics.

6' x 36": 72 in x 36 in (182 cm x 914 mm)
 6' x 42": 72 in x 42 in (182 cm x 106 cm)
 6": 72 in (182 cm)

8' x 36": 96 in x 36 in (243 cm x 914 mm)
 8' x 42": 96 in x 42 in (243 cm x 106 cm)



FIND A BUILDER



ORDERING HELP



DESIGN HELP

3 RAIL KITS (continued)

COMPONENT	ORIENTATION	DIMENSIONS	ITEM #	COLORS
Glass Rail Kit Includes top rail, bottom rail, and mounting and support hardware. Glass infill sold separately. To complete your rail section, visit glass.trex.com	Horizontal	6' Glass Railing Kit	XXA06HGLRK	WT BK
Glass Panel For use with Trex Signature® Glass Rail Kit.	Horizontal	for 36" Rail Height		Visit glass.trex.com to order custom glass panels to complete your build.
		for 42" Rail Height		

4 INFILL PANEL

COMPONENT	ORIENTATION	DIMENSIONS	ITEM #	COLOR
Mesh Panel For use with Trex Signature® Mesh Rail Kit. Dimensions above are nominals. See below for actuals and metrics. 6' x 36": 64 in x 32.375 in (162 cm x 822 mm) 8' x 36": 88 in x 32.375 in (223 cm x 822 cm) 8' x 42": 88 in x 38.375 in (223 cm x 974 cm) Universal: 108.1875 in x 36.1875 in (274 cm x 919 mm)	Horizontal	6' x 36" Mesh Panel	SSMESH0636HZ	SS
		8' x 36" Mesh Panel	SSMESH0836HZ	
		8' x 42" Mesh Panel	SSMESH0842HZ	
	Stair	Universal Stainless Steel Mesh Panel	SSMESHUNIVST	

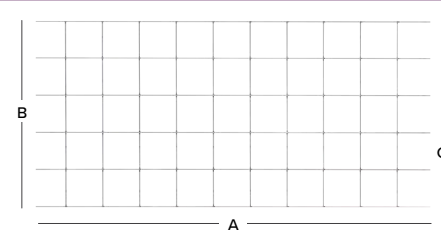
	PANEL	A (WIDTH)	B (HEIGHT)	C (CROSS-HATCHING)
	6' x 36" Horizontal	64"	32.375"	4"
	8' x 36" Horizontal	88"	32.375"	
	8' x 42" Horizontal	88"	38.375"	
	8' x 42" Stair	108.1875"	36.1875"	

XX = COLOR PREFIX









XXXX = COLOR COMBINATION

WT Classic White BK Charcoal Black
 BZ Bronze SS Stainless Steel

HOME



ACCESSORIES

COMPONENT	DESCRIPTION	ORIENTATION	ITEM #	COLORS
IRC Aluminum Mounting Plate & Hardware Includes hardware for 2.5" IRC Trex Signature surface mount posts, 1 aluminum backer plate, 4 HG carriage bolts and 4 HG washers and nuts. 	Surface mount post attachment hardware for wood substructure used to achieve IRC-compliant post attachment.	n/a	ALPOSTHWDECK	n/a
Concrete Post Mount Kit Includes (4) 3/8" x 3-3/4" (9.5 mm x 76 mm) expansion anchors, 4 flat washers and 4 hex nuts. 	Surface mount post attachment hardware for concrete used to achieve IRC-compliant post attachment.	n/a	ALPOSTHWCONC	n/a
Fascia Mount Bracket - Wood Framing Includes fascia mount bracket. 	Required for the mounting of Trex Signature joist mount post; for fascia mount applications only.	n/a	XXFMNTWOOD	WT BZ BK
Fascia Mount Post - Corner Kit Includes fascia mount bracket and hardware for joist mount double-corner posts, used for fascia-mounted Trex Signature railing installations. Fascia mount brackets also required. For wood frames only. 	Mounting bracket and hardware for joist mount double-corner posts, used for fascia-mounted Trex Signature railing installations. Fascia mount brackets also required. For wood frames only.	n/a	XXCORNERFMNTWOOD	WT BZ BK
Rod Rail Vertical Cut Kits Includes end verticals, anti-rattle straws and mounting hardware. 	Use as an accessory for cut rod rail kit sections. Brackets not included.	Horizontal	XX36RODHVERTK	BK
			XX42RODHVERTK	
		Stair	XX36RODSVERTK	
			XX42RODSVERTK	
Mesh Rail Vertical Cut Kits Includes vertical supports, vertical gaskets, L-brackets and hardware. 	Use as an accessory for cut mesh rail kit sections. Includes 1 bracket pack.	Horizontal	XX36MSHHVERTK	BZ BK
			XX42MSHHVERTK	
		Stair	XX36MSHSVVERTK	
			XX42MSHSVVERTK	
Trex Signature Bracket Templates Includes 1 reusable template. 	Simplify bracket placement when installing Trex Signature aluminum railing with 4" x 4" Trex composite post sleeves.	Horizontal	SIGTEMP4X4SLEEVE	n/a
			Simplify bracket placement when installing Trex Signature aluminum posts.	
Cocktail Rail Bracket Includes 10 brackets and 40 color-matched screws. 	Mounting hardware to attach a deck board or 2" x 4" cocktail rail to the top rail of Trex Signature rail kits. Only Trex solid core boards can be used. Not compatible with Signature Glass railing or Signature X-Series railing.	n/a	XXCTBKAL10PK	WT BZ BK

COMPONENT	DESCRIPTION	ORIENTATION	ITEM #	COLORS
Fixed Bracket Includes 2 top rail brackets with covers, 2 bottom rail brackets with covers, 1 fastener pack and (2) 3M VHB adhesive tabs. 	Brackets with tabs removed to work with assembled panels, glass railing and mesh railing.	Horizontal	XXFHBKALPNL	WT BZ BK
		Stair	XXFSBKAL	
Swivel Bracket Includes 2 swivel brackets: 1 top and 1 bottom, 2 fastener covers and 1 fastener pack. 	Use for angled applications to achieve up to a 45° angle off the post.	Horizontal	XXSWHBKAL	WT BZ BK
		Stair	XXSWSBKAL	
Compound Swivel Bracket Includes 2 compound swivel brackets: 1 top and 1 bottom, 2 fastener covers and 1 fastener pack. 	Use for applications where maximum bracket flexibility is required, such as flared stair railing. Use in place of fixed stair brackets.	Stair	XXCPDSWBKAL	WT BZ BK
Crossover Bracket Includes crossover bracket, cover and mounting hardware. 	Use to create continuously graspable top rail on horizontal sections. Bracket is included on horizontal crossover posts (see page 36).	Horizontal	XX25FHCBKAL	WT BZ BK
90° Crossover Bracket Includes crossover bracket, cover and mounting hardware. 	Use to create continuously graspable top horizontal rails along a 90° turn in the railing.	Horizontal	XX90FHCBKAL	WT BZ BK
Signature Rail End Cap Includes 1 end cap. 	Aluminum end cap designed to cover Signature Railing end when rails are not terminated at the post.	Horizontal	XXXOVERENDCAP	WT BZ BK
Swivel Crossover Bracket Includes 1 swivel crossover bracket and 2 post-to-bracket fasteners. 	Use to maintain an uninterrupted top rail down stairs. Internal nut loosens to allow various angles.	Stair	XX25RCSWSCBKAL	WT BZ BK
Aluminum Foot Block Includes 1 foot block, anchor and fastener. 	Use to reinforce the bottom rail. Required for 8' sections.	Horizontal	XXALFTBLK	WT BZ BK
Extended Aluminum Foot Block Includes 1 foot block, anchor and fastener. 	Use for stairs or unique situations when rail heights differ. This cut-to-length accessory will provide extra reach and support to the rail section.	n/a	XXAL08FTBLK	WT BZ BK
Touch-up Pen Includes 1 touch-up pen. 	If you scratch a Trex Signature aluminum rail, use these touch-up pens to make the issue disappear.	n/a	XXTOUCHUPPEN	WT BZ BK

3 RAIL KITS

COMPONENT	ORIENTATION	DIMENSIONS	ITEM #	COLORS
Rail & Square Composite Baluster Kit Includes Crown top rail, Universal bottom rail, square composite balusters, baluster spacers, adjustable foot block and mounting hardware. Color option indicates rails and balusters.	Horizontal	6' x 36" Rail & Baluster Kit	XX0636HRKFS	WT BK VL
		8' x 36" Rail & Baluster Kit	XX0836HRKFS	
		6' x 42" Rail & Baluster Kit	XX0642HRKFS	
		8' x 42" Rail & Baluster Kit	XX0842HRKFS	
	Stair	6' x 36" Rail & Baluster Kit	WT0636SRKFS	WT
		8' x 36" Rail & Baluster Kit	XX0836SRKFS	WT BK VL
8' x 42" Rail & Baluster Kit		XX0842SRKFS	WT BK VL	
Rail & Round Aluminum Baluster Kit Includes Crown top rail, Universal bottom rail, round aluminum balusters, baluster spacers, adjustable foot block and mounting hardware. Color option indicates rails. Round aluminum balusters come in BK.	Horizontal	6' x 36" Rail & Baluster Kit	XXRD0636HRKFS	WT BK VL
		8' x 36" Rail & Baluster Kit	XXRD0836HRKFS	
		6' x 42" Rail & Baluster Kit	XXRD0642HRKFS	
		8' x 42" Rail & Baluster Kit	XXRD0842HRKFS	
	Stair	8' x 36" Rail & Baluster Kit	XXRD0836SRKFS	WT BK VL
		8' x 42" Rail & Baluster Kit	XXRD0842SRKFS	WT BK VL
Cocktail Rail & Round Aluminum Baluster Kit Includes 2 Universal top/bottom rails, round aluminum balusters, baluster spacers, adjustable foot block and mounting hardware. Color option indicates rails. Round aluminum balusters come in BK. Only Trex solid core deck boards can be used for cocktail rail applications.	Horizontal	6' x 36" Cocktail Rail & Baluster Kit	WTRD0636HRKCKTLFS	WT
		8' x 36" Cocktail Rail & Baluster Kit	WTRD0836HRKCKTLFS	
	Stair	8' x 36" Cocktail Rail & Baluster Kit	WTRD0836SRKCKTLFS	

Dimensions above are nominals. See below for actuals and metrics.

6' x 36": 72 in x 36 in (182 cm x 914 mm)	8' x 36": 96 in x 36 in (243 cm x 914 mm)
6' x 42": 72 in x 42 in (182 cm x 106 cm)	8' x 42": 96 in x 42 in (243 cm x 106 cm)

3a TOP RAILS

COMPONENT	DIMENSIONS	ITEM #	COLORS
Top Rail Universal top rail is used for cocktail rail applications.	6' Crown Top Rail	XXCROWNTR06FS	WT BK RS VL
	8' Crown Top Rail	XXCROWNTR08FS	

3b BOTTOM RAILS

COMPONENT	DIMENSIONS	ITEM #	COLORS
Universal Top/Bottom Rail Includes 1 Universal top/bottom rail.	6' Universal Top/Bottom Rail	XXUNIVTBR06FS	WT BK RS VL
	8' Universal Top/Bottom Rail	XXUNIVTBR08FS	

Dimensions above are nominals. See below for actuals and metrics.

6': 72 in (182 cm)
 8': 96 in (243 cm)



FIND A BUILDER



ORDERING HELP



DESIGN HELP



XX = COLOR PREFIX

WT Classic White RS Rope Swing
 BK Charcoal Black VL Vintage Lantern

HOME



4 INFILLS

	COMPONENT	ORIENTATION	DIMENSIONS	ITEM #	COLORS	
COMPOSITE	Square Composite Balusters Includes 16 square composite balusters.		Horizontal / Stair	Balusters for 36" Rail Height <i>16 pack</i>	XX020230SBK	WT BK RS VL
			Horizontal / Stair	Balusters for 42" Rail Height <i>16 pack</i>	XX020236SBK	
ALUMINUM	Round Aluminum Balusters Includes 20 round aluminum balusters.		Horizontal / Stair	Balusters for 36" Rail Height <i>20 pack</i>	XXTA30RBK	WT BZ BK
			Horizontal / Stair	Balusters for 42" Rail Height <i>20 pack</i>	XXTA36RBK	

Dimensions above are nominals. See below for actuals and metrics.

- 6' Full Span Rail: 72 in (182 cm)
- 8' Full Span Rail: 96 in (243 cm)
- Composite 36" Baluster: 1.418 in x 1.418 in x 30.375 in (36 mm x 36 mm x 771 mm)
- Composite 42" Baluster: 1.418 in x 1.418 in x 36.375 in (36 mm x 36 mm x 923 mm)
- Aluminum 36" Baluster: .75 in x 30.25 in (19 mm x 768 mm)
- Aluminum 42" Baluster: .75 in x 36.25 in (19 mm x 920 mm)

HOW MANY BALUSTERS DO YOU NEED TO COMPLETE A RAILING SECTION?*

BALUSTER TYPE	6' SECTION	8' SECTION
Square composite Horizontal	14	19
Square composite Stair	11	15
Round aluminum Horizontal	16	21
Round aluminum Stair	13	17

*Trex Transcend Railing

APPROXIMATE LENGTH OF BALUSTER BY APPLICATION

	SIGNATURE		TRANSCEND		SELECT	
	36"	42"	36"	42"	36"	42"
Round Aluminum	33.485	39.485	30.250	36.250	32.000	38.000
Round Pinned Aluminum	31.406	37.406	-	-	-	-
Square Aluminum	33.485	39.485	-	-	-	-
Square Pinned Aluminum	31.406	37.406	-	-	-	-
Square Composite	-	-	30.375	36.375	32.000	38.000



FIND A BUILDER





ORDERING HELP



DESIGN HELP

5 ACCESSORY INFILL KITS

	COMPONENT	ORIENTATION	DIMENSIONS	ITEM #	COLORS	
COMPOSITE	Square Composite Baluster Infill Kit Includes baluster spacers, adjustable foot block and mounting hardware.		Horizontal	6' Accessory Infill Kit	XXSQHIK06FS	WT BK RS VL
			Horizontal	8' Accessory Infill Kit	XXSQHIK08FS	
		Stair	6' Accessory Infill Kit	XXSQSIK06FS		
			8' Accessory Infill Kit	XXSQSIK08FS		
ALUMINUM	Round Aluminum Baluster Infill Kit Includes 2 baluster spacers, adjustable foot block and mounting hardware.		Horizontal	6' Accessory Infill Kit	XXRDHIK06FS	WT BK RS VL
			Horizontal	8' Accessory Infill Kit	XXRDHIK08FS	
		Stair	6' Accessory Infill Kit	XXRDSIK06FS		
			8' Accessory Infill Kit	XXRDSIK08FS		

Dimensions above are nominals. See below for actuals and metrics.

- 6': 72 in (182 cm)
- 8': 96 in (243 cm)

XX = COLOR PREFIX

- Composite: WT Classic White BK Charcoal Black RS Rope Swing VL Vintage Lantern
- Aluminum: WT Classic White BZ Bronze BK Charcoal Black



HOME



TREX TRANSCEND® RAILING

COMPONENT	DESCRIPTION	ORIENTATION	ITEM #	COLORS
Trex Transcend Bracket Templates Includes 1 reusable template. 	Reusable template to simplify bracket placement when installing Trex Transcend railing with 4" x 4" Trex composite post sleeves.	Horizontal	TSCTEMP4X4SLEEVE	n/a
Foot Block Includes 1 adjustable foot block. 	Use to reinforce the rail; required for every Trex composite rail section.	n/a	XXFTBLKPC	WT BK RS VL
Mounting Hardware for Cut Rails Includes 2 Crown top rail gaskets, 4 Universal Top/bottom rail gaskets, 4 RSB rail brackets for horizontal or 8 RSB brackets for stair. 	The perfect solution for any installation that requires making two railing sections from one kit.	Horizontal	XXHZACCYKIT	WT BK RS VL
		Stair	XXSTACCYKIT	
Transcend RSB Bracket Pack Includes RSB rail brackets, rail-to-bracket fasteners and rail-to-post fasteners. 	Use this with mounting hardware kit without the gaskets.	Horizontal	TSHBRACKET	n/a
		Stair	TSSBRACKET	
0° Rail Gasket Pack Includes 2 Crown top rail gaskets and 4 Universal top/bottom rail gaskets. 	Gasket pack for Trex Transcend railing installed at a 0° angle off the post. Hardware not included.	Horizontal	XX00HGASK	WT BK RS VL
		Stair	XX00SGASK	
22.5° Rail Gasket Pack Includes 2 Crown top rail gaskets and 4 Universal top/bottom rail gaskets. 	Gasket pack for Trex Transcend railing installed at a 22.5° angle off the post. Hardware not included.	Horizontal	XX22HGASK	WT BK RS VL
45° Birdsmouth Gasket Pack Includes (4) 45° adapters for RSB Rail Brackets, 2 Crown top rail gaskets and 4 Universal top/bottom rail gaskets. 	For 4" x 4" post. Bracket adapter pack for Trex Transcend railing installed at a 45° angle off the post. Hardware not included.	Horizontal	XX45RSBADAPK	WT BK RS VL
45° Gasket Pack Includes 2 Crown top rail gaskets and 4 Universal top/bottom rail gaskets. 	For 6" x 6" post. Bracket adapter pack for Trex Transcend railing installed at a 45° angle off the post. Hardware not included.	Horizontal	WT45HGASK	WT

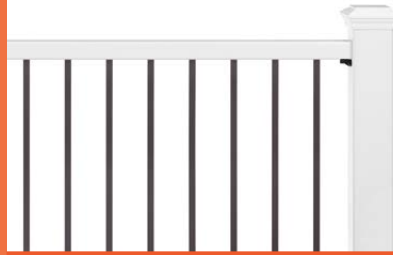
TREX SELECT® RAILING

COMPONENT	ORIENTATION	DIMENSIONS	ITEM #	COLORS
Classic Rail & Round Aluminum Baluster Kit Includes top rail, bottom rail, round aluminum balusters, adjustable foot block and hardware pack. Color option indicates WT rails. Round aluminum balusters come in BK. 	Horizontal	6' x 36" Classic Rail & Baluster Kit	WTRD0636HSELKFS	WT
		8' x 36" Classic Rail & Baluster Kit	WTRD0836HSELKFS	
		6' x 42" Classic Rail & Baluster Kit	WTRD0642HSELKFS	
		8' x 42" Classic Rail & Baluster Kit	WTRD0842HSELKFS	
	Stair	6' x 36" Classic Rail & Baluster Kit	WTRD0636SSELKFS	
		8' x 36" Classic Rail & Baluster Kit	WTRD0836SSELKFS	
8' x 42" Classic Rail & Baluster Kit		WTRD0842SSELKFS		
T-Rail & Round Aluminum Baluster Kit Includes top rail, bottom rail, round aluminum balusters, adjustable foot block and hardware pack. Color option indicates WT rails. Round aluminum balusters come in BK. 	Horizontal	6' x 36" T-Rail & Baluster Kit	WTRD0636HSELTRK	WT
		8' x 36" T-Rail & Baluster Kit	WTRD0836HSELTRK	
		6' x 42" T-Rail & Baluster Kit	WTRD0642HSELTRK	
		8' x 42" T-Rail & Baluster Kit	WTRD0842HSELTRK	
	Stair	6' x 36" T-Rail & Baluster Kit	WTRD0636SSELTRK	
		8' x 36" T-Rail & Baluster Kit	WTRD0836SSELTRK	
8' x 42" T-Rail & Baluster Kit		WTRD0842SSELTRK		
T-Rail & Square Composite Baluster Kit Includes top rail, bottom rail, square composite balusters, adjustable foot block and hardware pack. Color option indicates WT rails and WT square composite balusters. 	Horizontal	6' x 36" T-Rail & Baluster Kit	WTSQ0636HSELTRK	WT
		8' x 36" T-Rail & Baluster Kit	WTSQ0836HSELTRK	
		6' x 42" T-Rail & Baluster Kit	WTSQ0642HSELTRK	
		8' x 42" T-Rail & Baluster Kit	WTSQ0842HSELTRK	
	Stair	6' x 36" T-Rail & Baluster Kit	WTSQ0636SSELTRK	
		8' x 36" T-Rail & Baluster Kit	WTSQ0836SSELTRK	
8' x 42" T-Rail & Baluster Kit		WTSQ0842SSELTRK		

Dimensions above are nominals. See below for actuals and metrics.

- 6' x 36": 72 in x 36 in (182 cm x 914 mm)
- 6' x 42": 72 in x 42 in (182 cm x 106 cm)
- 8' x 36": 96 in x 36 in (243 cm x 914 mm)
- 8' x 42": 96 in x 42 in (243 cm x 106 cm)



FIND A BUILDER



ORDERING HELP



DESIGN HELP

XX = COLOR PREFIX

Composite: WT Classic White BK Charcoal Black RS Rope Swing VL Vintage Lantern

HOME



TREX SELECT® RAILING

COMPONENT	DESCRIPTION	ORIENTATION	ITEM #	COLORS
Mounting Hardware for Cut Classic Rails Includes 8 bracket-to-post fasteners, 12 bracket-to-rail fasteners and 4 railing brackets.	Use to mount 1 section of Select Classic Rail. The perfect solution for any installation that requires making two railing sections from one kit.	Horizontal	PBKENHZBKT	BK
		Stair	PBKENSTBKT	
Mounting Hardware for Cut T-Rails Includes 8 bracket to post fasteners, 14 bracket to rail fasteners, 2 top rail and 2 bottom rail brackets.	Use to mount 1 section of Select T-Rail. The perfect solution for any installation that requires making two railing sections from one kit.	Horizontal	PTRLHBKTKIT	WT
		Stair	PTRLSTBTKIT	
8 ft Aluminum Classic Rail Stiffener Includes 1 aluminum rail stiffener.	Use to strengthen and stabilize the 8' rail. IRC-compliant applications only. Compatible with Select Classic top rails only.	n/a	SELALRAILSTIFFENER	n/a
8 ft Aluminum T-Rail Stiffener (IRC) Includes 1 aluminum rail stiffener.	Use to strengthen and stabilize the 8' rail. IRC-compliant applications only. Compatible with Select T-Rail top rails only.	n/a	SELALTRAILSTIFFNR	n/a
Foot Block Includes 1 adjustable foot block.	Use to reinforce the rail; required for every Trex composite rail section.	n/a	XXFTBLKPC	WT BK RS VL
T-Rail 22.5° Left Bracket Pack Includes 4 bracket-to-post fasteners, 7 bracket-to-rail fasteners, 1 top rail and 1 bottom rail bracket.	Bracket pack for Select T-Rail railing installed at a 22.5° angle off the post. Hardware included.	n/a	TRL22LBKTKIT	WT
T-Rail 22.5° Right Bracket Pack Includes 4 bracket-to-post fasteners, 7 bracket-to-rail fasteners, 1 top rail and 1 bottom rail bracket.	Bracket pack for Select T-Rail railing installed at a 22.5° angle off the post. Hardware included.	n/a	TRL22RBKTKIT	WT
T-Rail 45° Birdsmouth Bracket Pack Includes 8 bracket-to-post fasteners, 4 bracket-to-rail fasteners, 1 top rail and 1 bottom rail bracket.	Bracket adapter pack for Select T-Rail railing installed at a 45° angle off the post. Hardware included.	n/a	TRLBMBKTKIT	WT

XX=COLOR PREFIX

WT Classic White BK Charcoal Black RS Rope Swing VL Vintage Lantern



FIND A BUILDER



ORDERING HELP



DESIGN HELP

RAILING ENHANCEMENTS

COMPONENT	DIMENSIONS	ITEM #	COLORS
Flat Post Cap Light Includes LED Post Cap Light and 5.5 ft. (1.67 m) Male LightHub® Lead. Use with Trex 4" composite railing posts.	4" x 4" LED Post Cap Light <i>Actual internal dimensions:</i> 4.55 in x 4.55 in (115 mm x 115 mm)	XXSQLEDCAP4X4C	WT BK RS VL
Solar Post Cap Light Use with Trex 4" composite railing posts.	4" x 4" Solar Post Cap Light <i>Actual internal dimensions:</i> 4.55 in x 4.55 in (115 mm x 115 mm)	XXSOLAR4x4CAP XXSOLAR4x4CAP XXSOLAR4x4CAP	WT VL BK
Aluminum Post Cap Light Includes LED Aluminum Post Cap Light and 5.5 ft. (1.67 m) Male LightHub® Lead. Use with Trex 2.5" Aluminum Railing Posts.	2.5" x 2.5" LED Aluminum Post Cap Light <i>Actual internal dimensions:</i> 2.6 in x 2.6 in (66 mm x 66 mm)	XXALCAPLED25	WT BZ BK
Aluminum Deck Rail Light Includes LED Deck Rail Light and 5.5 ft. (1.67 m) Male LightHub® Lead.	LED Deck Rail Light <i>Actual dimensions:</i> 2.75 in (69 mm)	XXLAMPLEDC	WT BZ BK
Aluminum Wedge Deck Rail Light Includes LED Wedge Deck Rail Light and 5.5 ft. (1.67 m) Male LightHub® Lead. Compatible with all Trex Railing Posts.	LED Deck Rail Light <i>Actual dimensions:</i> 1.875 in x 3 in (47 mm x 76 mm)	XXALPOSTLAMPLED	WT BZ BK
Aluminum Stair Riser Light Includes 4 LED Stair Riser Lights and 5.5 ft. (1.67 m) Male LightHub® Lead.	Stair Riser Lights <i>Actual dimensions:</i> 1.25 in (31 mm)	XXRISERLED4PKC	WT BZ BK
Recessed Deck Light Includes 4 LED Recessed Lights and 5.5 ft. (1.67 m) Male LightHub® Lead.	Recessed Deck Lights <i>Actual dimensions:</i> 1 in (25 mm)	RECESSLED4PKC	n/a

XX = COLOR PREFIX

Composite: WT Classic White BK Charcoal Black RS Rope Swing VL Vintage Lantern

Aluminum: WT Classic White BZ Bronze BK Charcoal Black

HOME











RAILING ENHANCEMENTS

OUTDOOR LIGHTING ACCESSORIES

COMPONENT	DIMENSIONS	ITEM #	COLORS
Transformer with Timer Includes transformer with photo-activated timer and 20 ft (6.09 m) LightHub® Wire Extension Cable. 	8.3A, 100W Dimmable Transformer <i>Output Voltage: 12VDC</i>	83DLTRANSFORMERCC	n/a
	2.5A, 30W Transformer <i>Output Voltage: 12VDC</i>	25DLTRANSFORMER	
Multizone Transformer Adapter Splits the Transformer ports for multi-zone installs. 	n/a	DL5TFSPPLIT1PK	n/a
Dimmer Includes single channel with remote. 	n/a	DLDIMMER	n/a
Wifi Lighting Controller 	n/a	DLWIFIC	n/a
Forstner Bit Includes 6 bits. 	Forstner Bit — 6 pack <i>Actual dimensions: 1 in (25 mm)</i>	DLBIT6PK	n/a
3-Way Splitter 	n/a	DL3SPLIT6PK	n/a
6-Way Splitter 	n/a	DL6SPLIT4PK	n/a
Wire Extension Cable 	5 ft (1.52 m) Wire Extension Cable	DL5FTWR4PK	n/a
	10 ft (3.04 m) Wire Extension Cable	DL10FTWR4PK	
	20 ft (6.09 m) Wire Extension Cable	DL20FTWR4PK	
20 ft Transformer Wire 	20 ft (6.09 m) Wire Cable	DL20FTWRWF1PK	n/a
Female-to-Female Adapter 	n/a	DLFADAP6PK	n/a

RAILING ENHANCEMENTS

ADA HANDRAIL

COMPONENT	DESCRIPTION	ITEM #	COLORS
Hand Rail 	Install to create a continuously graspable 8 ft rail. <i>Actual dimensions: 1.375 in x 96 in (34 mm x 243 cm)</i>	XXALADARAIL8	WT BZ BK
Wall Return 90° 	Termination bracket for ADA installation.	XXALADA90WR2G	WT BZ BK
Wall Mount 	Supports the rail as it spans past posts to create a continuously graspable rail.	XXALADAWMNT2G	WT BZ BK
Corner Mount 	Mount to the inside corner of a post to create a turn on a landing.	XXALADAICORNER2G	WT BZ BK
Post Return ("Candy Cane") 	Allows installations to terminate back into the top and/or bottom post.	XXALADA180CCANE	WT BZ BK
5° Elbow 	Use for wheelchair ramps; allows the 180° "Candy Cane" to be installed parallel to the ground. Match the angle of stairs to the angle of this elbow.	XXALADA05ELB	WT BZ BK
31° Elbow 	Use with 180° "Candy Cane". Needed to make sure the termination is parallel to the ground. Match the angle of stairs to the angle of this elbow.	XXALADA31ELB	WT BZ BK
34° Elbow 	Use with 180° "Candy Cane". Needed to make sure the termination is parallel to the ground. Match the angle of stairs to the angle of this elbow.	XXALADA34ELB	WT BZ BK
36° Elbow 	Use with 180° "Candy Cane". Needed to make sure the termination is parallel to the ground. Match the angle of stairs to the angle of this elbow.	XXALADA36ELB	WT BZ BK



FIND A BUILDER



ORDERING HELP



DESIGN HELP

XX = COLOR PREFIX







WT Classic White BZ Bronze BK Charcoal Black

HOME



RAILING ENHANCEMENTS

ADA HANDRAIL

COMPONENT	DESCRIPTION	ITEM #	COLORS
90° Inside/Outside Elbow 	Use on turns inside stair landings or used in creative ways to create railing terminations.	XXALADA90ELB2G	WT BZ BK
ADA Adjustable Elbow 	Use with 180 degree "Candy Cane" to ensure termination is parallel to the ground. Use in other unique ways to create railing terminations.	XXALADAADJELB	WT BZ BK
Straight 4" Internal Connector 	Use where two hollow pieces come together. Collar is included to ensure a smooth transition between pieces.	XXALINTCONN	WT BZ BK
Inline Rail Termination Adapter 	The inline bracket is used for straight-line terminations such as into a post or a wall.	XXALADAINLINE	WT BZ BK
Rail End Cap 	Aluminum end cap used to cover up the hollow handrail at the end of termination.	XXALADACAP	WT BZ BK
Aluminum Collar 	Use as needed to ensure all gaps are covered.	XXALADACL	WT BZ BK



OUR ADA-COMPLIANT HANDRAIL SYSTEM USES MULTIPLE COMPONENTS TO CREATE A CONTINUOUSLY GRASPABLE HANDRAIL.

- 1 Hand Rail
- 2 Wall Mount
- 3 Aluminum Collar
- 4 Post Return (Candy Cane)
- 5 Wall Return 90°

RAILING ENHANCEMENTS

GATES

COMPONENT	DIMENSIONS	ITEM #	COLORS
Gate Rail Kit - Square Balusters Includes 1 welded gate panel, 2 pre-punched 2" gate posts, (2) 2" gate post caps and 16 aluminum screws. 	36" Rail Height, adjustable up to 48" wide opening <i>Actual dimensions: 120 cm x 914 mm</i>	XX36SQADJGATE	WT BZ BK
	42" Rail Height, adjustable up to 48" wide opening <i>Actual dimensions: 120 cm x 106 cm</i>	XX42SQADJGATE	
Gate Rail Kit - Round Balusters Includes 1 welded gate panel, 2 pre-punched 2" gate posts, (2) 2" gate post caps and 16 aluminum screws. 	36" Rail Height, adjustable up to 48" wide opening <i>Actual dimensions: 120 cm x 914 mm</i>	XX36RDADJGATE	WT BZ BK
	42" Rail Height, adjustable up to 48" wide opening <i>Actual dimensions: 120 cm x 106 cm</i>	XX42RDADJGATE	
Hardware Pack Includes 2 glass-filled nylon hinges (stainless internals), 1 locking latch with keys, 18 aluminum screws and 10 wood screws. 	Hardware Pack	BKGATEHW	BK



FIND A BUILDER



ORDERING HELP



DESIGN HELP

XX = COLOR PREFIX

WT Classic White BZ Bronze BK Charcoal Black

HOME





TREX® RAILING AND ANCILLARY PRODUCTS LIMITED WARRANTY

Trex Company, Inc. (hereinafter “Trex”) warrants to the original end-use purchaser (“Purchaser”) that, for the applicable Warranty Period set forth in Table I below, when properly installed, used and maintained under normal use and service conditions, and in accordance with Trex’s written instructions, Trex® product set forth in Table I below (the “Product”) shall be free from material defects in workmanship and materials, and shall not split, splinter, rot or suffer structural damage from termites or fungal decay.

Residential/Commercial Application: For purposes of this warranty, a “residential application” shall refer to an installation of the Product on an individual residence, and a “commercial application” shall refer to any installation of the Product other than on an individual residence.

Term of Limited Warranty: The term of this Limited Warranty for a Product (the “Warranty Period”) begins on the date of original purchase and shall be equal to the number of years set forth next to such Product in Table I below.

TABLE I

Product	Residential Warranty Period	Commercial Warranty Period
Trex Signature® Railing, Trex Signature® X-Series™ Railing	25 Years	25 Years
Trex Signature® X-Series™ Cable Rail (Cable Infill/Assemblies ONLY)	10 Years	10 Years
Trex Transcend® Railing, Trex Select® Railing, Trex Enhance® Railing, Trex® Fencing, and TrexTrim™	25 Years	10 Years
Trex® Deck Lighting (LEDs and Housings)	7 Years	7 Years
Trex® Deck Lighting (Transformer, Timer, Dimmer, WiFi Controller, Solar Components)	3 Years	3 Years
Trex® Deck Lighting (Solar Battery)	1 Year	1 Year

Transferability: With respect to a residential application, this warranty may be transferred one (1) time, within the five (5) year period beginning from the date of original purchase by the Purchaser, to a subsequent buyer of the property upon which the Product was originally installed. With respect to a commercial application, this warranty is freely transferable to subsequent buyers of the property upon which the Product was originally installed.

EXCLUSIONS FROM WARRANTY COVERAGE

Notwithstanding the foregoing, (a) the warranty for Trex® Deck Lighting Products (excluding Trex® Solar Post Cap Lights) is valid only in each case provided that a Trex transformer is used (with no warranty on any components if a Trex transformer is not used), and any other Trex® Deck Lighting parts or accessories not listed in Table I above shall not be warranted; (b) this warranty shall not apply to any Trex products not listed in Table I, including, but not limited to, Trex decking products, Trex cladding products, Trex fascia products and Trex fasteners (which each have separate warranties); and (c) with respect to installations where the atmosphere is influenced by a body of salt water (or other contaminant conditions), failure to adhere to the cleaning guidelines available at www.trex.com will void this warranty with respect to any condition resulting from such failure.

The Product must be stored, handled, installed, used and maintained in accordance with instructions provided by Trex, and this Limited Warranty is conditioned upon compliance with all such instructions. Copies of Trex’s Installation Guides, Technical Information and Care and Cleaning Guides are available from Trex at the address listed below. The materials may also be obtained on Trex’s website at trex.com.

Any information or suggestion by Trex with respect to the Product concerning applications, specifications or compliance with codes and standards, including building or safety codes, is provided solely for Purchaser’s convenient reference and is made without any representation as to accuracy or suitability. Purchaser must verify and test the suitability of any information with respect to the Product for Purchaser’s specific application.

Trex does not warrant against and is not responsible for any condition attributable to: (1) improper installation of Product and/or failure to abide by Trex’s installation guidelines; (2) use of Product beyond normal use and service conditions, or in an application not recommended by Trex’s guidelines and local building codes; (3) movement, distortion, collapse or settling of the ground or the supporting structure on which Product is installed; (4) any act of God (such as flooding, hurricane, earthquake, lightning, etc.), environmental condition (such as air pollution, mold, mildew, etc.), exposure to corrosive elements or atmospheric contaminants (such as salt spray, salt air, chemicals, pollution, etc.), staining from foreign substances (such as dirt, grease, oil, etc.), tarnishing, or normal weathering (defined as exposure to sunlight, weather and atmosphere which will cause any colored surface to gradually fade, chalk, or accumulate dirt or stains); (5) variations or changes in color of Product; (6) improper handling, storage, abuse or neglect of Product by Purchaser, the transferee or third parties; (7) ordinary wear and tear; (8) vandalism; or (9) other causes beyond the control of Trex.

PROCEDURE FOR MAKING A CLAIM UNDER THIS LIMITED WARRANTY

To make a claim under this Limited Warranty, Purchaser, or the transferee, shall send to Trex, within the Warranty Period referred to above, a written description and photographs of the claimed defect and proof of purchase, to the following address:

Trex Company, Inc.
Customer Relations
2500 Trex Way
Winchester, VA 22601

Upon confirmation by an authorized Trex representative of a valid claim hereunder, Trex’s sole responsibility shall be, at its option, to either: (a) replace the affected Product with new Product in an amount equal to the amount of defective material; or (b) refund the portion of the purchase price paid by Purchaser for such affected Product (not including the cost of its initial installation). Replacement Product will be as close in color, design and quality to the original Product as reasonably possible, in Trex’s discretion and determination, but Trex does not guarantee an exact match as colors and designs may change and Trex’s obligation as to replacement shall further be limited to replacement with the styles and colors of the Product that are available at the time of the replacement.

THE REMEDIES STATED IN THIS PARAGRAPH ARE PURCHASER’S SOLE AND EXCLUSIVE REMEDIES FOR ANY PRODUCT THAT FAILS TO CONFORM TO THIS LIMITED WARRANTY.

If a valid warranty claim hereunder is made during year eleven (11) or any year thereafter through the expiration of the applicable Warranty Period after the original purchase, recovery will be prorated in accordance with Table II, below. If Trex is providing replacement materials, it may elect to replace the percentage listed in Table II, below, of Product otherwise meeting the requirements for a claim, or if it is refunding the purchase price, it may elect to refund the percentage listed below in Table II of the purchase price of Product otherwise meeting the requirements for a claim.

TABLE II

Year of Claim	Recovery
11	80%
12	80%
13	80%
14	60%
15	60%
16	60%
17	40%
18	40%
19	40%
20	20%
21	20%
22	20%
23	10%
24	10%
25	10%

TO THE FULLEST EXTENT PERMITTED UNDER THE LAW, TREX’S SOLE OBLIGATION UNDER THIS LIMITED WARRANTY SHALL BE, AT ITS OPTION, REPLACEMENT OF NON-CONFORMING PRODUCT OR A REFUND OF THE PURCHASE PRICE, AS DESCRIBED ABOVE. PURCHASER ASSUMES ALL RISK WHATSOEVER AS TO THE RESULT OF THE USE OF THE PRODUCT PURCHASED, WHETHER USED SINGULARLY OR IN COMBINATION WITH ANY OTHER PRODUCTS OR SUBSTANCES.

TO THE FULLEST EXTENT PERMITTED UNDER THE LAW, THIS LIMITED WARRANTY SHALL NOT COVER AND TREX SHALL NOT BE RESPONSIBLE FOR COSTS AND EXPENSES INCURRED WITH RESPECT TO THE REMOVAL OF DEFECTIVE PRODUCT OR THE INSTALLATION OF REPLACEMENT MATERIALS, INCLUDING BUT NOT LIMITED TO LABOR AND FREIGHT.

No person or entity is authorized by Trex to make and Trex shall not be bound by any statement or representation as to the quality or performance of Product other than as contained in this Limited Warranty. This Limited Warranty may not be altered or amended except in a written instrument signed by Trex and Purchaser.

TO THE FULLEST EXTENT PERMITTED UNDER THE LAW, UNDER NO CIRCUMSTANCES WILL TREX BE LIABLE FOR ANY SPECIAL, INDIRECT, INCIDENTAL, CONSEQUENTIAL, RELIANCE, STATUTORY, SPECIAL, PUNITIVE OR EXEMPLARY DAMAGES, INCLUDING, BUT NOT LIMITED TO, LOST PROFITS, LOSS OF USE, LOSS OF TIME, LOSS OF REVENUES, INCONVENIENCE, LOSS OF BUSINESS OPPORTUNITIES OR DAMAGE TO GOOD WILL OR REPUTATION DAMAGES, WHETHER SUCH DAMAGES ARE SOUGHT IN CONTRACT, IN TORT (INCLUDING, BUT NOT LIMITED TO, NEGLIGENCE AND STRICT LIABILITY) OR OTHERWISE, EVEN IF ADVISED OF THE POSSIBILITY OF SUCH DAMAGES OR SUCH DAMAGES COULD HAVE BEEN REASONABLY FORESEEN, IN CONNECTION WITH, ARISING OUT OF, OR AS A RESULT OF, THE SALE, DELIVERY, INSTALLATION, USE OR LOSS OF USE OF THE PRODUCT SOLD HEREUNDER, OR FOR ANY LIABILITY OF PURCHASER TO ANY THIRD PARTY WITH RESPECT THERETO AND TREX’S LIABILITY FOR NON-PERSONAL INJURY CLAIMS WITH RESPECT TO DEFECTIVE PRODUCT SHALL IN NO EVENT EXCEED THE REPLACEMENT OF SUCH PRODUCT OR REFUND OF THE PURCHASE PRICE, AS DESCRIBED ABOVE.

Some States or Provinces do not allow the exclusion or limitation of incidental or consequential damages, so the above limitation or exclusion may not apply to you. This Limited Warranty gives you specific legal rights, and you may also have other rights that vary from State to State or Province to Province.

Copyright © 2024 Trex Company, Inc.



Need help with your build?

Explore Trex Academy, where you'll find step-by-step installation help, pro tips and guides to the railing process.

Planning Made Simple

Design your deck with easy-to-use online tools, from simple comparisons to detailed plans and shopping lists.



COLOR SELECTOR



COST CALCULATOR



DECKING COMPARISON



DECK DESIGNER



AR VISUALIZER

Deck Designer Tool

Bring your vision to life. Our Deck designer tool helps you handpick every element of your deck and preview it in 3D.

Only available on desktop.



Trex AR Visualizer

Trex® helps you find your outdoor inspiration with this unique augmented reality AR visualizer. This free AR tool allows you to virtually “build” a deck in your backyard space. Use the app* to explore basic deck shapes, colors, and styles—giving you a realistic way to visualize how your deck will look in nearly any outdoor or indoor environment.

**Requires download. Only available on mobile.*



FIND A BUILDER



ORDERING HELP



DESIGN HELP

HOME





Engineering What's Next
in Outdoor Living®

DECKING | RAILING | FASTENERS | FASCIA | LIGHTING | KITCHENS | FURNITURE | PERGOLA
DRAINAGE | SPIRAL STAIRS | CORNHOLE | LATTICE | CLADDING | FENCING

Visit [trex.com](https://www.trex.com) or call **1-800-BUY-TREX**

FIND US ON



© 2024 Trex Company, Inc. All rights reserved. Trex®, the Trex logo, TrexPro®, Trex Enhance®, Trex Select®, Trex Transcend®, Trex Transcend® Lineage™, Trex Signature®, Trex® OutdoorLighting, Trex Hideaway®, Trex® Pergola, Trex® Outdoor Kitchens, Trex® Outdoor Furniture, Trex® Cladding, Trex® Fascia, Trex® Spiral Stairs, Trex® Cornhole, Trex® Lattice and Trex® Fencing are either federally registered trademarks, trademarks or trade dress of Trex Company, Inc., Winchester, Virginia or its licensees.
© 2024 Warner Bros. Discovery, Inc. or its subsidiaries and affiliates. All trademarks are the property of their respective owners. All rights reserved.