



TJI[®] 110, TJI[®] 210, TJI[®] 230, TJI[®] 360, TJI[®] 560 AND TJI[®] 560D JOISTS

Featuring Trus Joist[®] TJI[®] Joists for
Floor and Roof Applications

- Uniform and Predictable
- Lightweight for Fast Installation
- Resource Efficient
- Resists Bowing, Twisting, and Shrinking
- Significantly Reduces Callbacks
- Available in Long Lengths
- Limited Product Warranty



Now featuring
18" - 24" TJI[®] joists





The products in this guide are readily available through our nationwide network of distributors and dealers. For more information on other applications or other Trus Joist® products, contact your Weyerhaeuser representative.

Code Evaluations:
ICC-ES ESR-1153; ESR-1387

TABLE OF CONTENTS

Fire-Safe Construction	3
Visual Literature Guide	4
TJ-Pro™ Rating and Floor Performance	5

SECTION 1: 9½"-16" TJI® Joists

Design Properties	6
Floor Span and Load Tables	7-8
Tips for Preventing Floor Noise	8
Allowable Holes	9
Cantilevers	10-11
Roof Span and Load Tables	12-13
Framing Connectors	14-15

SECTION 2: 18"-24" TJI® Joists

Design Properties	16
Floor Span and Load Tables	17
Allowable Holes	18
Roof Span and Load Tables	19
Cantilevers	20-21
Framing Connectors	22-23

SECTION 3: Design Information for All Joists

TJI® Joist Floor Framing	24
Rim Board Selection and Installation	25
Floor Details	26-27
Roof Framing	28
Roof Details	29-30
Cut Length Calculation	31
Material Weights and Conversion Table	31



Certified Sourcing
www.sfiprogram.org
SFI-00008

Why Choose Trus Joist® TJI® Joists?

- Engineered for strength and consistency
- Efficient installation saves time and labor
- Longer lengths allow more versatile floor plans
- Less jobsite waste
- Fewer red tags and callbacks



Now more than ever builders need solutions that really deliver. That's why Trus Joist® TJI® joists are designed to give you more—longer lengths, easier installation, higher span values, better strength-to-weight ratios, and faster cycle times.

TJI® joists are also available in deeper depths that are suitable for heavier-duty loads, such as those in multi-family structures and light commercial buildings.

This guide features TJI® joists in the following sizes:

Depths: 9½", 11⅞", 14", 16", 18", 20", 22", and 24"

Flange Widths: 1¾", 2¼", 2⅝", and 3½"

Flange height and thickness vary by series; see the appropriate sections of this guide for specific sizes and relevant technical information:

9½"-16" JOISTS **Section 1:**
Design information for 9½"-16" TJI® joists

18"-24" JOISTS **Section 2:**
Design information for 18"-24" TJI® joists

ALL JOIST DEPTHS **Section 3:**
Framing details and design information for all joist depths in this guide

Some products may not be available in your region.

Contact your Weyerhaeuser representative at our [Specification Center](#) or visit "[Where to Buy](#)".

PRODUCT STORAGE

Protect product from sun and water



CAUTION:
Wrap is slippery when wet or icy

Align stickers (2x3 or larger) directly over support blocks

Use support blocks (6x6 or larger) at 10' on-center to keep bundles out of mud and water



WARNING: This product can expose you to chemicals including wood dust which are known to the State of California to cause cancer, and methanol, which are known to the State of California to cause birth defects or other reproductive harm. Drilling, sawing, sanding or machining wood products can expose you to wood dust. Avoid inhaling wood dust or use a dust mask or other safeguards for personal protection. For more information go to www.P65Warnings.ca.gov and www.P65Warnings.ca.gov/wood.

Safety data sheets for all Weyerhaeuser wood products can be found on our website at: weyerhaeuser.com/sustainability/environment/product-stewardship/safety-data-sheets.

FIRE-SAFE CONSTRUCTION

Fire-safe construction and life safety are major concerns for everyone in the building materials and construction industry. The 2015 U.S. Fire Administration statistics ([usfa.fema.gov/data/statistics/](https://www.usfa.fema.gov/data/statistics/)) on residential and commercial fires in the U.S. alone include 3,280 fire fatalities and an estimated \$14.3 billion in property damage. These numbers underscore the seriousness of the issue and the need for fire-safe construction.

For over 40 years, prefabricated wood I-joists and other Weyerhaeuser building products have established a record of safe and reliable performance in millions of structures. Many of these structures, such as one- or two-family residential dwellings, do not require specific fire-resistance ratings per building codes but may require unrated membrane protection. The information below is intended to help you specify and install Trus Joist® products with fire safety in mind.

Passive Fire Protection

Independent tests show that when compared to protected systems, unprotected framing systems (whether combustible or non-combustible) suffer increased structural degradation when exposed to fire. All floor framing materials—sawn lumber, wood I-joists, trusses, and light-gauge steel—succumb quickly to fire if not protected. Applying a protective membrane, such as gypsum ceiling board, to all types of floor framing within the structure will provide uniform protection to the structural framing members. Passive fire protection can do the following:

- Delay fire growth involving structural elements
- Reduce the potential for significant property damage to structural elements

Smoke Detectors

Smoke detectors are universally recognized as the most cost-effective life-saving devices. Although smoke detectors do not provide protection to the structure or to the contents in a home, they do alert occupants to potential fire hazards and allow them time to escape. Similarly, carbon monoxide detectors can also alert occupants to faulty heating appliances or air contamination in the early stages of a fire.

Active Fire Suppression

Automatic fire sprinkler systems are commonly required by building codes in schools, office buildings, factories, and other commercial buildings. Buildings designed with sprinkler systems are allowed larger areas and greater heights than buildings designed without sprinkler systems.

Fire service agencies such as the U.S. Fire Administration promote the use of residential sprinkler systems, citing benefits such as lower overall cost of construction for the homebuilder, plus a safer environment and lower insurance rates for the homeowner. Using automatic fire sprinkler systems provides the following benefits:

- Early and unsupervised suppression
- Reduced fire and smoke development
- Potentially enhanced life safety for the occupant(s)

Floor Assembly Compliant with 2012 IRC R501.3, 2015 and 2018 IRC R302.13

Single Layer

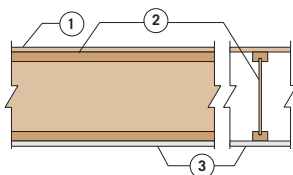

1. Appropriate span-rated sheathing (Exposure 1)
2. TJI® joist
3. Single-layer of ½" gypsum wall board

One-Hour Assembly for Rated Construction

Double Layer

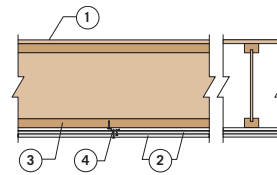

1. 48/24 tongue-and-groove, span-rated sheathing (Exposure 1), glued with a subfloor adhesive and nailed
2. Two layers of ½" Type X gypsum board
3. TJI® joist
4. Resilient channels (optional)*

Optional: Minimum 3½"-thick glass fiber insulation or non-combustible insulation, rated R-30 or less.*

***Resilient channels are required when insulation is used.**

*See ESR-1153 for other insulation options.

For more information on fire assemblies and fire-safe construction, please refer to the Weyerhaeuser Fire-Rated Assemblies and Sprinkler Systems Guide, *TJ-1500*, or visit our website at [weyerhaeuser.com/woodproducts](https://www.weyerhaeuser.com/woodproducts).

VISUAL LITERATURE GUIDE



Roof Framing

Roof System Design Guide:
[TJ-9005](#)

Truss Chords:
[9008](#)

Floor/Ceiling Assemblies

Fire Assemblies and Sprinklers:
[TJ-1500](#)

CVPC piping to TJI web:
[TJ-1500](#)

Sound Ratings:
[TJ-4035](#)

Energy Codes

Allowable Holes for
Trus Joist Products:
[TJ-9015](#)

Floor Framing

TJI® Joist Specifier's Guide:
[TJ-4000](#)

TimberStrand® LSL Guide:
[TJ-8014](#)

TimberStrand® LSL Rim Board

Rim Board Guide:
[TJ-8000](#)

Deck Ledger Attachment:
[TB-304](#)

Exterior Decks

Parallam® Plus PSL:
[TJ-7102](#)

Preservative Wood Treatments
of Weyerhaeuser Engineered
Wood Products:
[TB-315](#)

Trus Joist® Coastal
Construction:
[TB-217](#)

TimberStrand® LSL Headers & Wall Framing

U.S. Wall Guide:
[TJ-9003](#)

Wall Guide: CA, NV, AZ:
[TJ-9004](#)

Installation Guides

Pocket Framer's Guide:
[TJ-9001](#)

Building Code Evaluations

ICC-ES Evaluation Report:
[ESR-1153](#)

ICC-ES Evaluation Report:
[ESR-1387](#)

Trus Joist® Engineered Wood Beams & Columns

Beams, Headers,
& Columns:
[TJ-9000](#)

Beams, Headers,
& Columns:
Pacific Coast & NW
[TJ-9020](#)

Stair Stringers and Treads

Specifier's Guide:
[9010](#)

Edge® / Edge Gold™ / Diamond™ Panels

Edge® and Edge Gold™ Panels:
[OSB-4000](#)

Diamond™ Floor Panels:
[OSB-4051](#)

Floor, Roof, and Wall Panel
Installation:
[TJ-4035](#)

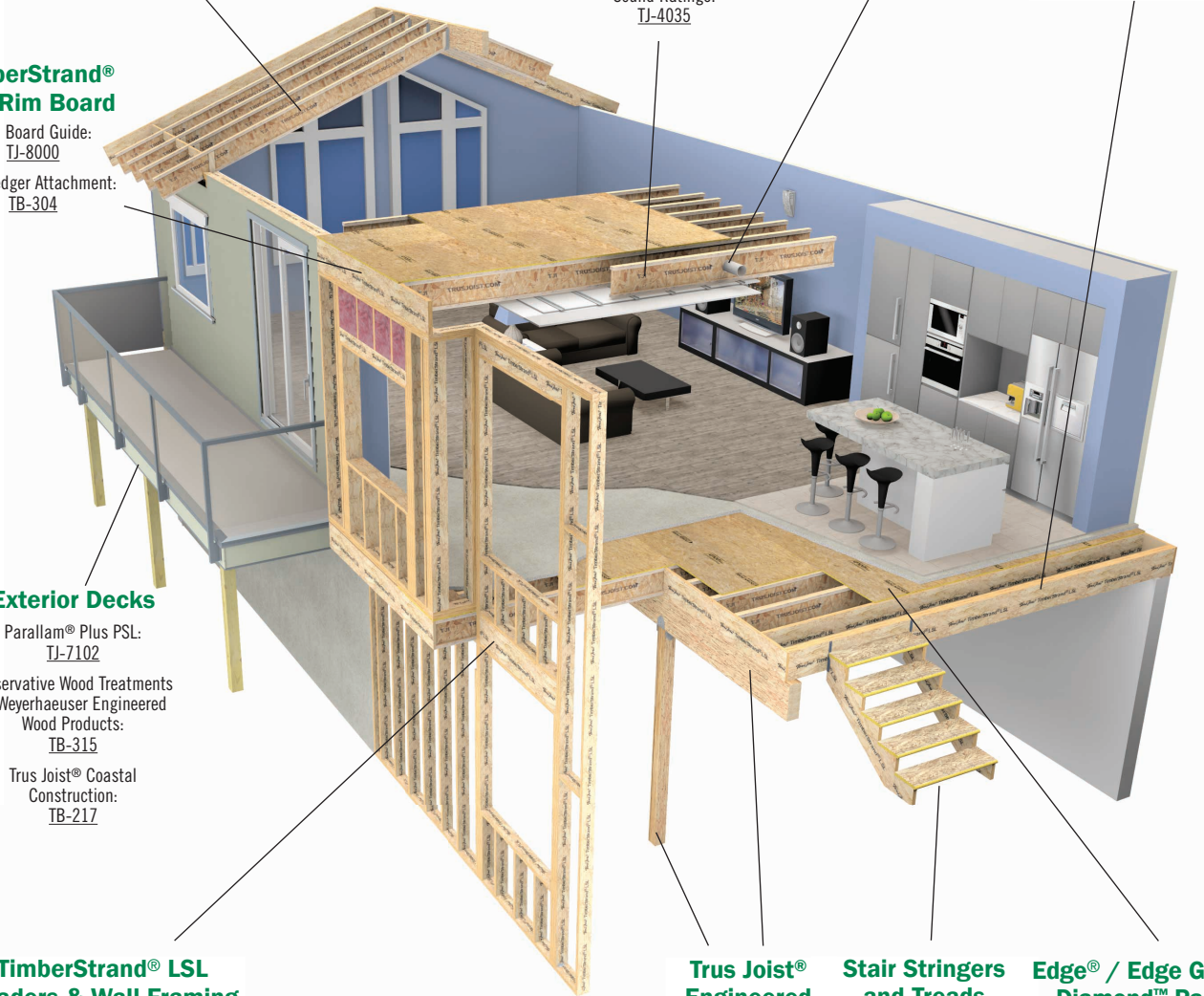

*Some products may not be available in your region.
Contact your Weyerhaeuser representative at our [Specification Center](#) or visit "[Where to Buy](#)".*

TJ-PRO™ RATING AND FLOOR PERFORMANCE

What is Floor Performance and TJ-Pro Rating?

Floor performance is how a floor feels under foot traffic. TJ-Pro Rating is a diagnostic tool developed by Weyerhaeuser to help you assess floor performance based on the floor assembly components you specify. You can access TJ-Pro rating using our [ForteWEB®](#) and [Javelin®](#) software platforms or our span table [web app](#).

How does TJ-Pro Rating Work?

Point values up to 65 are assigned using complex algorithms based on field and laboratory research conducted on over 600 floor system assemblies. It also factors in the variables listed under **Key Factors Affecting Performance** shown to the right. Ranges can then be correlated to customer floor performance expectations.



What do the ratings mean?

The ratings represent the percentage of customers that would be satisfied with the floor performance. At 45 points, customer satisfaction is 84%. At 65 points, it's nearly 100%.

How can you use TJ-Pro Rating?

You know your market and TJ-Pro Ratings let you build what your market needs. For example, once you know that a TJ-Pro Rating of 45 points works for your customers, you can simply target 45 points for your other floors to deliver the performance your market expects.

It's also a great tool to optimize floors for the type of home you build:

Entry Level: Focus on economy and efficiency. Use TJ-Pro Ratings to make sure you're not overbuilding.

Move-Up/Mid-Level: Countless floor plans with upgrades options. Use TJ-Pro Rating to consistently and reliably build across the range of framing solutions.

High-End Luxury: Uncompromised quality and reputation is key. From our experience, homeowners in this group expect a rating of 45 points or greater. Use TJ-Pro Rating to differentiate yourself and deliver the quality your customers demand.

Key Factors Affecting Performance

- **Basic Stiffness** is a combination of joist depths and span.
- **Composite Action**—Careful nailing in conjunction with construction adhesives increases basic stiffness.
- **Continuity**—Continuous joists over several supports generally perform better than simple spans. Care must be taken if the joists continue into another occupancy.
- **Joist Spacing and Deck Stiffness**—Reduced spacing or increased deck thickness generally improves floor performance.
- **Ceilings** directly applied to the bottom edge of the floor members, or equivalent 1x or 2x strapping, is a performance enhancement.
- **Beams**—Floor systems supported by steel or wood beams tend to feel less stiff than those supported by solid bearing walls.
- **Bridging or Blocking** can be a contributor to improved floor performance.
- **Non-bearing Partition Walls** dampen vibration and improve floor performance when installed transverse to the floor joists.
- **Mass** reduces damping in a floor system causing a decrease in floor performance. This impact is more noticeable as span lengths increase.

TJ-Pro Rating is featured in these design software platforms.



Autodesk® Revit® linked to ForteWEB®

Let one of our experienced **Territory Managers** perform a TJ-Pro Rating assessment on your floors to give you insight on how well your floors will perform against your customers expectations. They can also help recommend products which will give you the optimal results you are looking for without overspending.

SECTION 1: 9½"-16" TJI® JOISTS

This section contains design information for 9½"-16" deep Trus Joist® TJI® joists.

These standard-size TJI® joists are readily available through your local Weyerhaeuser dealer or distributor. Offered with the flange sizes shown below, they come in lengths up to 60' (in 1' increments).

Design Properties (100% Load Duration)

Depth	TJI®	Basic Properties				Reaction Properties					
		Joist Weight (lbs/ft)	Maximum Resistive Moment ⁽¹⁾ (ft-lbs)	Joist Only EI x 10 ⁶ (in. ² -lbs)	Maximum Vertical Shear (lbs)	1¾" End Reaction (lbs)	3½" End Reaction (lbs)	3½" Intermediate Reaction (lbs)		5¼" Intermediate Reaction (lbs)	
								No Web Stiffeners	With Web Stiffeners ⁽²⁾	No Web Stiffeners	With Web Stiffeners ⁽²⁾
9½"	110	2.3	2,500	157	1,220	910	1,220	1,935	N.A.	2,350	N.A.
	210	2.6	3,000	186	1,330	1,005	1,330	2,145	N.A.	2,565	N.A.
	230	2.7	3,330	206	1,330	1,060	1,330	2,410	N.A.	2,790	N.A.
11⅞"	110	2.5	3,160	267	1,560	910	1,375	1,935	2,295	2,350	2,705
	210	2.8	3,795	315	1,655	1,005	1,460	2,145	2,505	2,565	2,925
	230	3.0	4,215	347	1,655	1,060	1,485	2,410	2,765	2,790	3,150
	360	3.0	6,180	419	1,705	1,080	1,505	2,460	2,815	3,000	3,360
14"	560	4.0	9,500	636	2,050	1,265	1,725	3,000	3,475	3,455	3,930
	110	2.8	3,740	392	1,860	910	1,375	1,935	2,295	2,350	2,705
	210	3.1	4,490	462	1,945	1,005	1,460	2,145	2,505	2,565	2,925
	230	3.3	4,990	509	1,945	1,060	1,485	2,410	2,765	2,790	3,150
16"	360	3.3	7,335	612	1,955	1,080	1,505	2,460	2,815	3,000	3,360
	560	4.2	11,275	926	2,390	1,265	1,725	3,000	3,475	3,455	3,930
	110	3.0	4,280	535	2,145	910	1,375	1,935	2,295	2,350	2,705
	210	3.3	5,140	629	2,190	1,005	1,460	2,145	2,505	2,565	2,925
16"	230	3.5	5,710	691	2,190	1,060	1,485	2,410	2,765	2,790	3,150
	360	3.5	8,405	830	2,190	1,080	1,505	2,460	2,815	3,000	3,360
	560	4.5	12,925	1,252	2,710	1,265	1,725	3,000	3,475	3,455	3,930

(1) **Caution: Do not** increase joist moment design properties by a repetitive member use factor.
 (2) See detail W on page 27 for web stiffener requirements and nailing information.

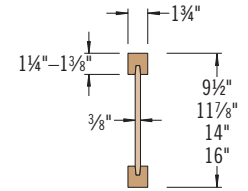

TJI® 110 joists

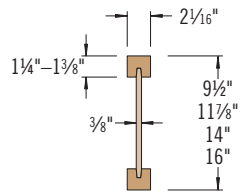

TJI® 210 joists

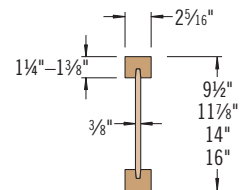

TJI® 230 joists

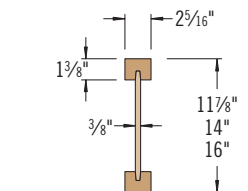

TJI® 360 joists

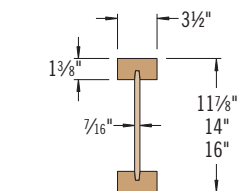

TJI® 560 joists

General Notes

- Design reaction includes all loads on the joist. Design shear is computed at the inside face of supports and includes all loads on the span(s). Allowable shear may sometimes be increased at interior supports in accordance with ICC-ES ESR-1153, and these increases are reflected in span tables.
- The formulas at right approximate the uniform load deflection of Δ (inches).

For TJI® 110, 210, 230, and 360 Joists

$$\Delta = \frac{22.5 wL^4}{EI} + \frac{2.67 wL^2}{d \times 10^5}$$

For TJI® 560 Joists

$$\Delta = \frac{22.5 wL^4}{EI} + \frac{2.29 wL^2}{d \times 10^5}$$

w = uniform load in pounds per linear foot
 L = span in feet
 d = out-to-out depth of the joist in inches
 EI = value from table above

TJI® joists are intended for dry-use applications

Some TJI® joist series may not be available in your region. Contact your Weyerhaeuser representative for information.



DO NOT walk on joists until braced. INJURY MAY RESULT.



DO NOT stack building materials on unsheathed joists. Stack only over beams or walls.



DO NOT walk on joists that are lying flat.

WARNING

Joists are unstable until braced laterally

Bracing Includes:

- Blocking
- Hangers
- Rim Board
- Sheathing
- Rim Joist
- Strut Lines

WARNING NOTES: Lack of proper bracing during construction can result in serious accidents. Observe the following guidelines:

- All blocking, hangers, rim boards, and rim joists at the end supports of the TJI® joists must be completely installed and properly nailed.
- Lateral strength, like a braced end wall or an existing deck, must be established at the ends of the bay. This can also be accomplished by a temporary or permanent deck (sheathing) fastened to the first 4 feet of joists at the end of the bay.
- Safety bracing of 1x4 (minimum) must be nailed to a braced end wall or sheathed area (as in note 2) and to each joist. Without this bracing, buckling sideways or rollover is highly probable under light construction loads—such as a worker or one layer of unnailed sheathing.
- Sheathing must be completely attached to each TJI® joist before additional loads can be placed on the system.
- Ends of cantilevers require safety bracing on both the top and bottom flanges.
- The flanges must remain straight within a tolerance of ½" from true alignment.

L/480 Live Load Deflection

Depth	TJI®	40 PSF Live Load / 10 PSF Dead Load				40 PSF Live Load / 20 PSF Dead Load			
		12" o.c.	16" o.c.	19.2" o.c.	24" o.c.	12" o.c.	16" o.c.	19.2" o.c.	24" o.c.
9½"	110	16'-11"	15'-6"	14'-7"	13'-7"	16'-11"	15'-6"	14'-3"	12'-9"
	210	17'-9"	16'-3"	15'-4"	14'-3"	17'-9"	16'-3"	15'-4"	14'-0"
	230	18'-3"	16'-8"	15'-9"	14'-8"	18'-3"	16'-8"	15'-9"	14'-8"
11⅞"	110	20'-2"	18'-5"	17'-4"	15'-9 ⁽¹⁾	20'-2"	17'-8"	16'-1 ⁽¹⁾	14'-4 ⁽¹⁾
	210	21'-1"	19'-3"	18'-2"	16'-11"	21'-1"	19'-3"	17'-8"	15'-9 ⁽¹⁾
	230	21'-8"	19'-10"	18'-8"	17'-5"	21'-8"	19'-10"	18'-7"	16'-7 ⁽¹⁾
	360	22'-11"	20'-11"	19'-8"	18'-4"	22'-11"	20'-11"	19'-8"	17'-10 ⁽¹⁾
14"	110	22'-10"	20'-11"	19'-2"	17'-2 ⁽¹⁾	22'-2"	19'-2"	17'-6 ⁽¹⁾	15'-0 ⁽¹⁾
	210	23'-11"	21'-10"	20'-8"	18'-10 ⁽¹⁾	23'-11"	21'-1"	19'-2 ⁽¹⁾	16'-7 ⁽¹⁾
	230	24'-8"	22'-6"	21'-2"	19'-9 ⁽¹⁾	24'-8"	22'-2"	20'-3 ⁽¹⁾	17'-6 ⁽¹⁾
	360	26'-0"	23'-8"	22'-4"	20'-9 ⁽¹⁾	26'-0"	23'-8"	22'-4 ⁽¹⁾	17'-10 ⁽¹⁾
16"	110	29'-6"	26'-10"	25'-4"	23'-6"	29'-6"	26'-10"	25'-4 ⁽¹⁾	20'-11 ⁽¹⁾
	210	25'-4"	22'-6"	20'-7 ⁽¹⁾	18'-1 ⁽¹⁾	25'-4"	22'-7 ⁽¹⁾	18'-9 ⁽¹⁾	15'-0 ⁽¹⁾
	230	26'-6"	24'-3"	22'-6 ⁽¹⁾	19'-11 ⁽¹⁾	26'-0"	22'-6 ⁽¹⁾	20'-7 ⁽¹⁾	16'-7 ⁽¹⁾
	360	27'-3"	24'-10"	23'-6"	21'-1 ⁽¹⁾	27'-3"	23'-9"	21'-8 ⁽¹⁾	17'-6 ⁽¹⁾
16"	110	28'-9"	26'-3"	24'-8 ⁽¹⁾	21'-5 ⁽¹⁾	28'-9"	26'-3 ⁽¹⁾	22'-4 ⁽¹⁾	17'-10 ⁽¹⁾
	210	28'-9"	26'-3"	24'-8 ⁽¹⁾	21'-5 ⁽¹⁾	28'-9"	26'-3 ⁽¹⁾	22'-4 ⁽¹⁾	17'-10 ⁽¹⁾
	230	28'-9"	26'-3"	24'-8 ⁽¹⁾	21'-5 ⁽¹⁾	28'-9"	26'-3 ⁽¹⁾	22'-4 ⁽¹⁾	17'-10 ⁽¹⁾
	360	28'-9"	26'-3"	24'-8 ⁽¹⁾	21'-5 ⁽¹⁾	28'-9"	26'-3 ⁽¹⁾	22'-4 ⁽¹⁾	17'-10 ⁽¹⁾

L/360 Live Load Deflection (Minimum Criteria per Code)

Depth	TJI®	40 PSF Live Load / 10 PSF Dead Load				40 PSF Live Load / 20 PSF Dead Load			
		12" o.c.	16" o.c.	19.2" o.c.	24" o.c.	12" o.c.	16" o.c.	19.2" o.c.	24" o.c.
9½"	110	18'-9"	17'-2"	15'-8"	14'-0"	18'-1"	15'-8"	14'-3"	12'-9"
	210	19'-8"	18'-0"	17'-0"	15'-4"	19'-8"	17'-2"	15'-8"	14'-0"
	230	20'-3"	18'-6"	17'-5"	16'-2"	20'-3"	18'-1"	16'-6"	14'-9"
11⅞"	110	22'-3"	19'-4"	17'-8"	15'-9 ⁽¹⁾	20'-5"	17'-8"	16'-1 ⁽¹⁾	14'-4 ⁽¹⁾
	210	23'-4"	21'-2"	19'-4"	17'-3 ⁽¹⁾	22'-4"	19'-4"	17'-8"	15'-9 ⁽¹⁾
	230	24'-0"	21'-11"	20'-5"	18'-3"	23'-7"	20'-5"	18'-7"	16'-7 ⁽¹⁾
	360	25'-4"	23'-2"	21'-10"	20'-4 ⁽¹⁾	25'-4"	23'-2"	21'-10⁽¹⁾	17'-10 ⁽¹⁾
14"	110	28'-10"	26'-3"	24'-9"	23'-0"	28'-10"	26'-3"	24'-9"	20'-11 ⁽¹⁾
	210	24'-4"	21'-0"	19'-2"	17'-2 ⁽¹⁾	22'-2"	19'-2"	17'-6 ⁽¹⁾	15'-0 ⁽¹⁾
	230	26'-6"	23'-1"	21'-1"	18'-10 ⁽¹⁾	24'-4"	21'-1"	19'-2 ⁽¹⁾	16'-7 ⁽¹⁾
	360	27'-3"	24'-4"	22'-2"	19'-10 ⁽¹⁾	25'-8"	22'-2"	20'-3 ⁽¹⁾	17'-6 ⁽¹⁾
16"	110	28'-9"	26'-3"	24'-9 ⁽¹⁾	21'-5 ⁽¹⁾	28'-9"	26'-3⁽¹⁾	22'-4 ⁽¹⁾	17'-10 ⁽¹⁾
	210	32'-8"	29'-9"	28'-0"	25'-2 ⁽¹⁾	32'-8"	29'-9"	26'-3⁽¹⁾	20'-11 ⁽¹⁾
	230	26'-0"	22'-6"	20'-7 ⁽¹⁾	18'-1 ⁽¹⁾	23'-9"	20'-7 ⁽¹⁾	18'-9 ⁽¹⁾	15'-0 ⁽¹⁾
	360	28'-6"	24'-8"	22'-6 ⁽¹⁾	19'-11 ⁽¹⁾	26'-0"	22'-6 ⁽¹⁾	20'-7 ⁽¹⁾	16'-7 ⁽¹⁾
16"	110	30'-1"	26'-0"	23'-9"	21'-1 ⁽¹⁾	27'-5"	23'-9"	21'-8 ⁽¹⁾	17'-6 ⁽¹⁾
	210	31'-10"	29'-0"	26'-10 ⁽¹⁾	21'-5 ⁽¹⁾	31'-10"	26'-10⁽¹⁾	22'-4 ⁽¹⁾	17'-10 ⁽¹⁾
	230	31'-10"	29'-0"	26'-10 ⁽¹⁾	21'-5 ⁽¹⁾	31'-10"	26'-10⁽¹⁾	22'-4 ⁽¹⁾	17'-10 ⁽¹⁾
	360	36'-1"	32'-11"	31'-0 ⁽¹⁾	25'-2 ⁽¹⁾	36'-1"	31'-6⁽¹⁾	26'-3 ⁽¹⁾	20'-11 ⁽¹⁾

(1) Web stiffeners are required at intermediate supports of continuous-span joists when the intermediate bearing length is *less* than 5¼" and the span on either side of the intermediate bearing is greater than the following spans:

TJI®	40 PSF Live Load / 10 PSF Dead Load				40 PSF Live Load / 20 PSF Dead Load			
	12" o.c.	16" o.c.	19.2" o.c.	24" o.c.	12" o.c.	16" o.c.	19.2" o.c.	24" o.c.
110	Not Req.	Not Req.	19'-2"	15'-4"	Not Req.	19'-2"	16'-0"	12'-9"
210			21'-4"	17'-0"		21'-4"	17'-9"	14'-2"
230			Not Req.	19'-2"		Not Req.	19'-11"	15'-11"
360			24'-5"	19'-6"		24'-5"	20'-4"	16'-3"
560			29'-10"	23'-10"		29'-10"	24'-10"	19'-10"

Long-term deflection under dead load, which includes the effect of creep, has not been considered. Bold italic spans reflect initial dead load deflection exceeding 0.33".

How to Use These Tables

- Determine the appropriate live load deflection criteria.
- Identify the live and dead load condition.
- Select on-center spacing.
- Scan down the column until you meet or exceed the span of your application.
- Select TJI® joist and depth.

General Notes

- Tables are based on:
 - Uniform loads.
 - More restrictive of simple or continuous span.
 - Clear distance between supports.
 - Minimum bearing length of 1¾" end (no web stiffeners) and 3½" intermediate.
- Assumed composite action with a single layer of 24" on-center span-rated, glue-nailed floor panels for deflection only. **When subfloor adhesive is not applied, spans shall be reduced 6" for nails and 12" for proprietary fasteners.**
- For continuous spans, ratio of short span to long span should be 0.4 or greater to prevent uplift.
- Spans generated from Weyerhaeuser software may exceed the spans shown in these tables because software reflects actual design conditions.
- For multi-family applications and other loading conditions not shown, refer to Weyerhaeuser software or to the load table on page 8.

Live load deflection is not the only factor that affects how a floor will perform. To more accurately predict floor performance, use TJI Pro™ Ratings included in ForteWEB® and our span table web application.

These Conditions Are NOT Permitted:



DO NOT use sawn lumber for rim board or blocking as it may shrink after installation. Use only engineered lumber

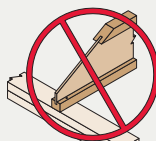

DO NOT bevel cut joist beyond inside face of wall.



DO NOT install hanger overhanging face of plate or beam. Flush bearing plate with inside face of wall or beam.

Floor—100% (PLF)

Depth	TJI®	Joist Clear Span																	
		8'		10'		12'		14'		16'		18'		20'		22'		24'	
		Live Load L/480	Total Load	Live Load L/480	Total Load	Live Load L/480	Total Load	Live Load L/480	Total Load	Live Load L/480	Total Load	Live Load L/480	Total Load	Live Load L/480	Total Load	Live Load L/480	Total Load	Live Load L/480	Total Load
9½"	110	*	190	140	152	85	127	56	99	38	76								
	210	*	210	161	169	99	141	65	119	45	90								
	230	*	236	175	190	108	158	71	133	49	99								
11¾"	110	*	190	*	152	*	127	92	109	63	95	45	76						
	210	*	210	*	169	*	141	106	121	74	106	53	92						
	230	*	236	*	190	*	158	116	136	80	119	58	102	43	83				
	360	*	241	*	193	*	162	136	139	95	121	69	108	51	97	39	78		
	560	*	294	*	236	*	197	*	169	138	148	101	132	76	119	58	108	45	91
14"	110	*	190	*	152	*	127	*	109	91	95	66	85						
	210	*	210	*	169	*	141	*	121	*	106	76	94	57	85				
	230	*	236	*	190	*	158	*	136	115	119	83	106	62	95	47	81		
	360	*	241	*	193	*	162	*	139	*	121	98	108	73	97	56	88	44	81
	560	*	294	*	236	*	197	*	169	*	148	*	132	107	119	83	108	65	99
16"	110	*	190	*	152	*	127	*	109	*	95	*	85	66	76				
	210	*	210	*	169	*	141	*	121	*	106	*	94	76	85	58	77		
	230	*	236	*	190	*	158	*	136	*	119	*	106	83	95	64	87	50	78
	360	*	241	*	193	*	162	*	139	*	121	*	108	*	97	75	88	59	81
	560	*	294	*	236	*	197	*	169	*	148	*	132	*	119	*	108	86	99

* Indicates that Total Load value controls.

How to Use This Table

1. Calculate actual total and live load in pounds per linear foot (plf).
2. Select appropriate Joist Clear Span.
3. Scan down the column to find a TJI® joist that meets or exceeds actual total and live loads.

Refer to PSF to PLF Conversion table on page 31

General Notes

- Table is based on:
 - Minimum bearing length of 1¾" end and 3½" intermediate, without web stiffeners.
 - Uniform loads.
 - More restrictive of simple or continuous span.
 - No composite action provided by sheathing.
- Total Load values are limited to deflection of L/240.
- Live Load is based on joist deflection of L/480.
- If a live load deflection limit of L/360 is desired, multiply value in Live Load column by 1.33. The resulting live load must not exceed the Total Load shown.
- Table does not account for concentrated loads. Use Weyerhaeuser software when this condition applies.

TIPS FOR PREVENTING FLOOR NOISE

Trus Joist® TJI® joists are structurally uniform and dimensionally stable, and they resist shrinking and twisting. This helps prevent gaps from forming around the nails between the joist and the floor panels—gaps that can potentially cause squeaks or other floor noise. Using TJI® joists can help you build a quieter floor, but only if the entire floor system is installed properly. This is because other components of the floor system, such as hangers, connectors, and nails can be a source of floor noise.

Properly Seat Each Joist in Hanger

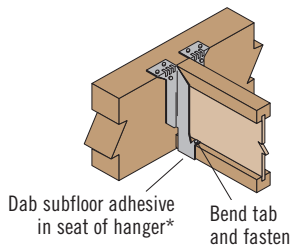

Seat the joist tight to the bottom of the hanger. When using hangers with tabs, bend the flange tabs over and nail to the TJI® joist bottom flange. Placing a dab of subfloor adhesive* in the seat of the hanger prior to installing the joist can reduce squeaks.

Use Adhesive and Special Nailing When Needed

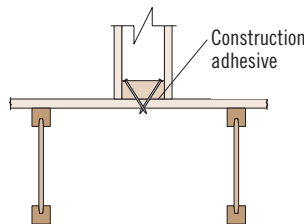

Nail interior partitions to the joists when possible. If the wall can be nailed only to the floor panel, run a bead of adhesive* under the wall and either cross nail, nail through and clinch tight, or screw tightly into the wall from below.

Prevent Shrinkage

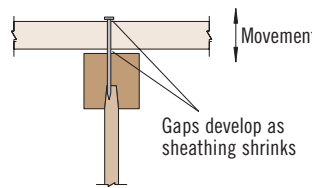

Keep building materials dry, and properly glue floor panels to the joists. Panels that become excessively wet during construction shrink as they dry. This shrinkage may leave gaps that allow the panel to move when stepped on.

Avoid "Shiners"

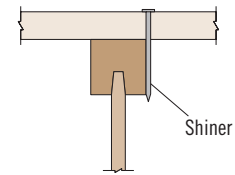

Exercise care when nailing. Nails that barely hit the joists (shiners) do not hold the panel tight to the joist and should be removed. If left in, the nails will rub against the side of the joist when the panel deflects.

* Weyerhaeuser recommends using a subfloor adhesive that has been qualified as a Class 1/8 in., Type P/O subfloor adhesive in accordance with ASTM D3498-12.

For more information and tips on how to prevent floor noise, refer to the Weyerhaeuser Prevention and Repair of Floor System Squeaks Technical Resource Sheet, 9009, or contact your Weyerhaeuser representative.

ALLOWABLE HOLES

9½" - 16" JOISTS

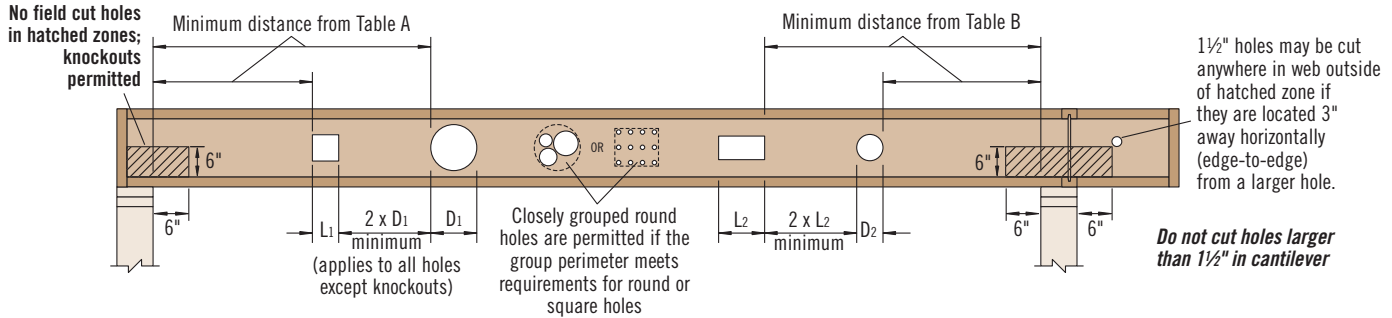

Table A, End Support: Minimum distance from edge of hole to inside face of nearest end support

Depth	TJI®	● Round Hole Size									■ Square or Rectangular Hole Size									
		2"	3"	4"	5"	6½"	7"	8⅞"	11"	13"	2"	3"	4"	5"	6½"	7"	8⅞"	11"	13"	
9½"	110	1'-0"	1'-6"	2'-0"	3'-0"	5'-0"					1'-0"	1'-6"	2'-6"	3'-6"	4'-6"					
	210	1'-0"	1'-6"	2'-6"	3'-0"	5'-6"					1'-0"	2'-0"	2'-6"	4'-0"	5'-0"					
	230	1'-6"	2'-0"	2'-6"	3'-6"	5'-6"					1'-0"	2'-0"	3'-0"	4'-6"	5'-0"					
11⅞"	110	1'-0"	1'-0"	1'-6"	2'-0"	2'-6"	3'-0"	5'-6"			1'-0"	1'-6"	2'-0"	2'-6"	4'-6"	5'-0"	6'-0"			
	210	1'-0"	1'-6"	2'-0"	2'-0"	3'-0"	3'-6"	6'-0"			1'-0"	1'-6"	2'-6"	3'-6"	5'-0"	5'-6"	6'-6"			
	230	1'-0"	1'-6"	2'-0"	2'-6"	3'-0"	3'-6"	6'-6"			1'-0"	2'-0"	2'-6"	3'-6"	5'-6"	5'-6"	7'-0"			
	360	1'-6"	2'-0"	3'-0"	3'-6"	4'-6"	5'-0"	7'-0"			1'-6"	2'-6"	3'-6"	4'-6"	6'-6"	6'-6"	7'-6"			
	560	1'-6"	2'-6"	3'-0"	4'-0"	5'-6"	6'-0"	8'-0"			2'-6"	3'-6"	4'-6"	5'-6"	7'-0"	7'-6"	8'-0"			
14"	110	1'-0"	1'-0"	1'-0"	1'-0"	1'-6"	2'-0"	3'-0"	5'-6"		1'-0"	1'-0"	1'-6"	2'-0"	3'-6"	4'-0"	6'-0"	8'-0"		
	210	1'-0"	1'-0"	1'-0"	1'-6"	2'-0"	2'-6"	3'-6"	6'-0"		1'-0"	1'-0"	2'-0"	2'-6"	4'-0"	4'-6"	6'-6"	8'-6"		
	230	1'-0"	1'-0"	1'-0"	1'-6"	2'-6"	2'-6"	4'-0"	7'-0"		1'-0"	1'-0"	2'-0"	3'-0"	4'-0"	5'-0"	7'-0"	9'-0"		
	360	1'-0"	1'-0"	1'-6"	2'-6"	3'-6"	4'-0"	5'-6"	8'-0"		1'-0"	1'-6"	2'-6"	4'-0"	6'-0"	6'-6"	8'-6"	9'-6"		
	560	1'-0"	1'-0"	2'-0"	3'-0"	4'-6"	5'-0"	6'-6"	9'-0"		1'-6"	3'-0"	4'-0"	5'-0"	7'-0"	7'-6"	9'-0"	10'-0"		
16"	110	1'-0"	1'-0"	1'-0"	1'-0"	1'-0"	1'-0"	2'-0"	3'-0"	5'-0"	1'-0"	1'-0"	1'-0"	1'-6"	3'-0"	3'-0"	5'-6"	7'-6"	10'-0"	
	210	1'-0"	1'-0"	1'-0"	1'-0"	1'-0"	1'-6"	2'-6"	3'-6"	6'-0"	1'-0"	1'-0"	1'-0"	2'-0"	3'-0"	3'-6"	6'-6"	8'-0"	11'-0"	
	230	1'-0"	1'-0"	1'-0"	1'-0"	1'-6"	1'-6"	3'-0"	4'-0"	7'-0"	1'-0"	1'-0"	1'-0"	2'-0"	3'-6"	4'-0"	7'-0"	9'-0"	11'-0"	
	360	1'-0"	1'-0"	1'-0"	1'-0"	2'-6"	2'-6"	4'-6"	6'-6"	9'-0"	1'-0"	1'-0"	1'-0"	1'-6"	3'-0"	5'-0"	5'-6"	9'-0"	10'-0"	11'-6"
	560	1'-0"	1'-0"	1'-0"	1'-0"	2'-6"	3'-0"	5'-0"	7'-6"	10'-0"	1'-0"	2'-0"	3'-0"	4'-6"	6'-6"	7'-0"	10'-0"	11'-0"	12'-0"	

Table B, Intermediate or Cantilever Support: Minimum distance from edge of hole to inside face of nearest intermediate or cantilever support

Depth	TJI®	● Round Hole Size									■ Square or Rectangular Hole Size								
		2"	3"	4"	5"	6½"	7"	8⅞"	11"	13"	2"	3"	4"	5"	6½"	7"	8⅞"	11"	13"
9½"	110	2'-0"	2'-6"	3'-6"	4'-6"	7'-6"					1'-6"	2'-6"	3'-6"	5'-6"	6'-6"				
	210	2'-0"	2'-6"	3'-6"	5'-0"	8'-0"					2'-0"	3'-0"	4'-0"	6'-6"	7'-6"				
	230	2'-6"	3'-0"	4'-0"	5'-6"	8'-6"					2'-0"	3'-6"	4'-6"	6'-6"	7'-6"				
11⅞"	110	1'-0"	1'-0"	1'-6"	2'-6"	4'-0"	4'-6"	8'-6"			1'-0"	1'-6"	2'-6"	4'-0"	7'-0"	7'-0"	9'-6"		
	210	1'-0"	1'-0"	2'-0"	3'-0"	4'-6"	5'-0"	9'-0"			1'-0"	2'-0"	3'-0"	4'-6"	8'-0"	8'-0"	10'-0"		
	230	1'-0"	2'-0"	2'-6"	3'-6"	5'-0"	5'-6"	10'-0"			1'-0"	2'-6"	3'-6"	5'-0"	8'-6"	9'-0"	10'-6"		
	360	2'-0"	3'-0"	4'-0"	5'-6"	7'-0"	7'-6"	11'-0"			2'-0"	3'-6"	5'-0"	7'-0"	9'-6"	9'-6"	11'-0"		
	560	1'-6"	3'-0"	4'-6"	5'-6"	8'-0"	8'-6"	12'-0"			3'-0"	4'-6"	6'-0"	8'-0"	10'-6"	11'-0"	12'-0"		
14"	110	1'-0"	1'-0"	1'-0"	1'-0"	2'-0"	2'-6"	4'-6"	8'-6"		1'-0"	1'-0"	1'-0"	2'-6"	5'-0"	6'-0"	9'-0"	12'-0"	
	210	1'-0"	1'-0"	1'-0"	1'-0"	2'-6"	3'-0"	5'-6"	9'-6"		1'-0"	1'-0"	2'-0"	3'-6"	6'-0"	7'-0"	10'-0"	13'-0"	
	230	1'-0"	1'-0"	1'-0"	2'-0"	3'-6"	4'-0"	6'-0"	10'-6"		1'-0"	1'-0"	2'-6"	4'-0"	6'-6"	7'-6"	11'-0"	13'-6"	
	360	1'-0"	1'-0"	2'-0"	3'-6"	5'-6"	6'-0"	8'-6"	12'-6"		1'-0"	2'-0"	4'-0"	5'-6"	9'-0"	10'-0"	12'-0"	14'-0"	
	560	1'-0"	1'-0"	1'-6"	3'-6"	5'-6"	6'-6"	9'-6"	13'-6"		1'-0"	3'-0"	5'-0"	7'-0"	10'-0"	11'-0"	13'-6"	15'-0"	
16"	110	1'-0"	1'-0"	1'-0"	1'-0"	1'-0"	1'-0"	2'-6"	5'-0"	8'-6"	1'-0"	1'-0"	1'-0"	1'-0"	3'-6"	4'-6"	8'-6"	11'-6"	15'-0"
	210	1'-0"	1'-0"	1'-0"	1'-0"	1'-0"	1'-0"	3'-6"	6'-0"	10'-0"	1'-0"	1'-0"	1'-0"	1'-6"	4'-6"	5'-6"	10'-0"	12'-6"	16'-0"
	230	1'-0"	1'-0"	1'-0"	1'-0"	1'-6"	2'-0"	4'-0"	6'-6"	11'-0"	1'-0"	1'-0"	1'-0"	2'-6"	5'-0"	6'-0"	10'-6"	13'-6"	16'-6"
	360	1'-0"	1'-0"	1'-0"	1'-0"	3'-0"	4'-0"	6'-6"	10'-0"	13'-6"	1'-0"	1'-0"	2'-0"	4'-0"	7'-6"	8'-6"	13'-0"	14'-6"	17'-0"
	560	1'-0"	1'-0"	1'-0"	1'-0"	2'-6"	3'-6"	7'-0"	11'-0"	15'-0"	1'-0"	1'-0"	3'-6"	5'-6"	9'-0"	10'-0"	14'-6"	16'-0"	18'-0"

■ Rectangular holes based on measurement of longest side.

How to Use These Tables

- Using **Table A**, **Table B**, or both if required, determine the hole shape/size and select the TJI® joist and depth.
- Scan horizontally until you intersect the correct hole size column.
- Measurement shown is minimum distance from edge of hole to support.
- Maintain the required minimum distance from the end **and** the intermediate or cantilever support.



WARNING: This product can expose you to chemicals including wood dust which are known to the State of California to cause cancer, and methanol, which are known to the State of California to cause birth defects or other reproductive harm. Drilling, sawing, sanding or machining wood products can expose you to wood dust. Avoid inhaling wood dust or use a dust mask or other safeguards for personal protection. For more information go to www.P65Warnings.ca.gov and www.P65Warnings.ca.gov/wood.

General Notes

- Holes may be located vertically anywhere within the web. Leave 1/8" of web (minimum) at top and bottom of hole.
- Knockouts are located in web at approximately 12" on-center; they do not affect hole placement and may be located in the hatched zone.
- For simple span (5' minimum) uniformly loaded joists meeting the requirements of this guide, one maximum size round hole may be located at the center of the joist span **provided that no other holes occur in the joist**.
- Distances are based on the maximum uniform loads shown in this guide. For other load conditions or hole configurations, use ForteWEB® software or contact your Weyerhaeuser representative.

DO NOT cut or notch flange.



DO NOT cut holes in cantilever reinforcement.



Cantilevers Less than 5" (Brick Ledge)

See Section A of cantilever table on page 11

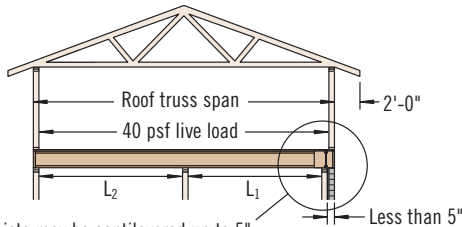

TJI® joists may be cantilevered up to 5" when supporting roof load, assuming:

- simple or continuous span
- $L_1 \leq L_2$
- minimum backspan = 2x cantilever length

Cantilevers 5" to 24"

See Section B of cantilever table on page 11

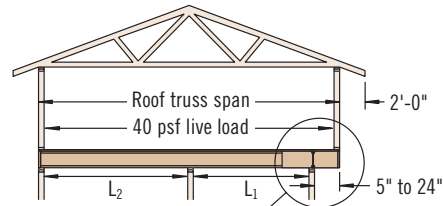

TJI® joists may be cantilevered 5" to 24" when supporting roof load, assuming:

- simple or continuous span
- $L_1 \leq L_2$
- minimum backspan = 2x cantilever length

PB1

Cantilever back span must be permanently braced with either direct-applied ceiling along entire length or permanent bracing at ⅓ points. See detail PB1 below for connections.

E1, E1W

Web stiffeners required both sides at E1W ONLY

8" diameter maximum hole for 11⅞"-16" deep blocking panels; 6" diameter maximum for blocking panels 9½" deep or shorter than 12" long. **Do not cut flanges.**

1½" TJI® Rim Board or 1¼" or 1½" TimberStrand® LSL closure, typical. Attach to joist with one (0.131" x 3") nail at top and bottom flanges.

E2, E3

4'-0" length of ¾" reinforcement (2'-0" maximum cantilever) on one side at E2, both sides at E3. Attach to joist flange with 8d (0.131" x 2½") nails at 6" on-center. When reinforcing both sides, stagger nails.

1½" TJI® Rim Board or 1¼" or 1½" TimberStrand® LSL, typical. Nail with (0.131" x 3") nails, one each at top and bottom flange.

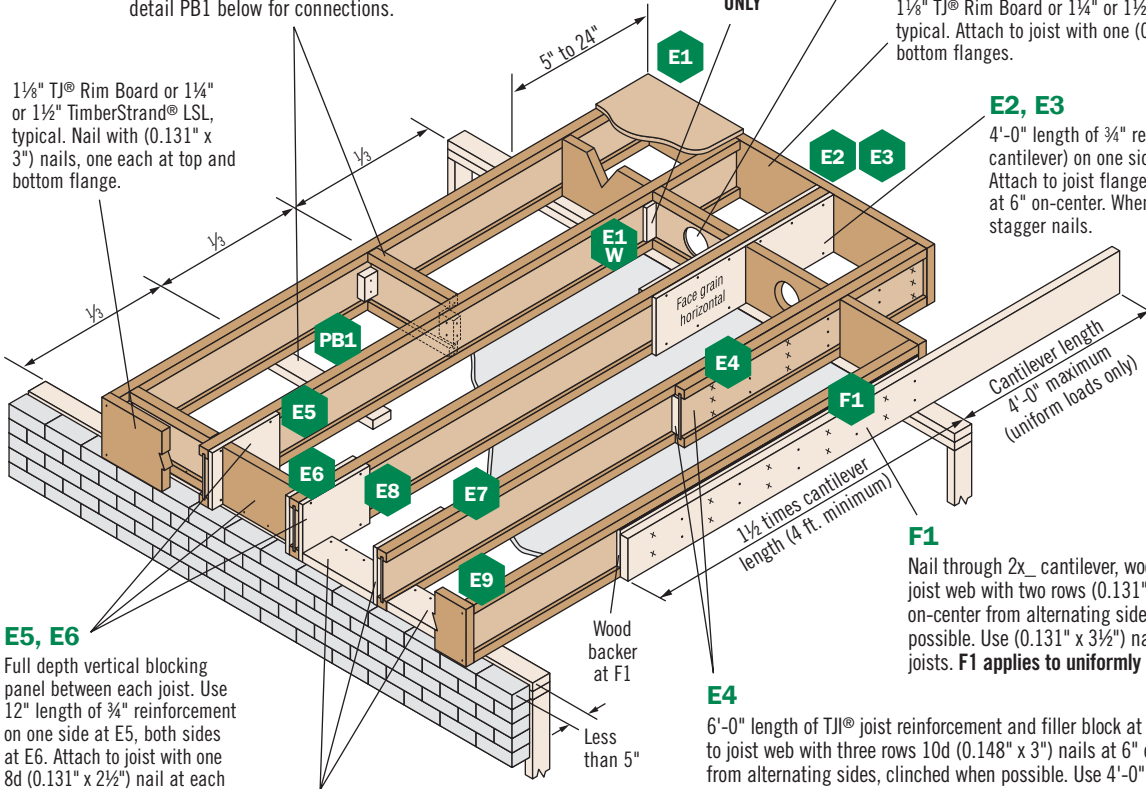

E5, E6

Full depth vertical blocking panel between each joist. Use 12" length of ¾" reinforcement on one side at E5, both sides at E6. Attach to joist with one 8d (0.131" x 2½") nail at each corner.

E7, E8, E9

Horizontal blocking panel between each joist. 12" length of ¾" reinforcement on one side with E7, both sides with E8. Attach to joist with one 8d (0.131" x 2½") nail at each corner. No reinforcement at E9. Nail rim to blocking panel and blocking panel to plate with connections equivalent to floor panel schedule.

E4

6'-0" length of TJI® joist reinforcement and filler block at E4. Attach to joist web with three rows 10d (0.148" x 3") nails at 6" on-center from alternating sides, clinched when possible. Use 4'-0" length with 9½" and 11⅞" TJI® joists, and attach to joist web with two rows 10d (0.148" x 3") nails at 6" on-center from alternating sides, clinched when possible. **Not for use with TJI® 560 joists.**

F1

Nail through 2x_ cantilever, wood backer, and TJI® joist web with two rows (0.131" x 3") nails at 6" on-center from alternating sides, clinched when possible. Use (0.131" x 3½") nails with TJI® 560 joists. **F1 applies to uniformly loaded joists only.**

Two 2½" screws for 2x_ strapping connections

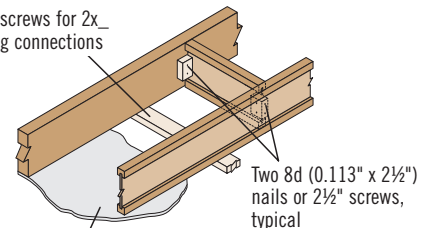

TJI® joists are intended for dry-use applications

Details E2–E9 are not for use with joist depths > 16". See pages 20–21 for cantilevers using deeper joists.

For more information on details E1–E9, refer to our cover sheets and AutoCAD details online at weyerhaeuser.com/woodproducts/software-learning.



When specified on the layout, one of the above bracing options is required

Cantilever Reinforcement

Depth	TJI®	Roof Truss Span	Section A: Cantilevers less than 5" (Brick Ledge)									Section B: Cantilevers 5" to 24"											
			Roof Total Load									Roof Total Load											
			35 PSF			45 PSF			55 PSF			35 PSF			45 PSF			55 PSF					
			On-Center Joist Spacing									On-Center Joist Spacing											
16"	19.2"	24"	16"	19.2"	24"	16"	19.2"	24"	16"	19.2"	24"	16"	19.2"	24"	16"	19.2"	24"						
9½" 11⅞" 14" 16"	110	20'						E5			E5						E2		X				
		22'			E5			E5			E5						E3		E2	X			
		24'			E5			E5			E5				E2		E2	X	E2	E3	X		
		26'			E5			E5	E5			E5	E5			E2		E3	X	E3	X	X	
		28'			E5			E5	E5	E5			E5	E5	E6		E2	E3	E2	X	X	X	
		30'		E5	X		E5	E5	X			E5	E5	X			E2	X	E3	X	X	X	
32'		X	X		E5	X	X			E5	X	X		E2	E3	X	X	X	X	X			
9½" 11⅞" 14" 16"	210	20'						E5			E5										E2		
		22'						E5			E5							E2		E2	E3		
		24'			E5			E5			E5	E5						E3		E2	X		
		26'			E5			E5			E5	E5				E2		E2	E3	E2	E3	X	
		28'			E5			E5	E5			E5	E5			E2		E3	X	E3	X	X	
		30'			E5			E5	E5	E5			E5	E5	E6		E3	E2	E3	X	X	X	
32'		E5	X			E5	X			E5	E5	X			E2	X	E3	X	X	X			
9½" 11⅞" 14" 16"	230	24'			E5			E5			E5	E5						E2		E2	X		
		26'			E5			E5			E5	E5						E3	E2	E3	X		
		28'			E5			E5	E5			E5	E5			E2		E2	X	E2	X	X	
		30'			E5			E5	E5	E5			E5	E5			E2	E2	E3	X	E3	X	
		32'		E5	E5			E5	E5	E5			E5	E5	E6		E2	E3	E2	X	X	X	
		34'		E5	X			E5	E5	X			E5	E5	X		E2	X	E3	X	X	X	
11⅞" 14" 16"	360	28'			E5			E5			E5	E5											
		30'			E5			E5			E5	E5										E2	
		32'			E5			E5	E5			E5	E5									E2	
		34'			E5			E5	E5	E5			E5	E5	E6								E3
		36'			E5			E5	E5	E5			E5	E5	E6				E2		E2	X	
		38'		E5	E5			E5	E5	E5			E5	E5	E6				E3		E3	X	
11⅞" 14" 16"	560	40'		E5	E5			E5	E5			E5	E5	E6			E2	E3	E2	E3	X		
		30'						E5			E5												
		32'						E5			E5												
		34'			E5			E5			E5												
		36'			E5			E5			E5												E2
		38'			E5			E5			E5												E2
40'			E5			E5	E5			E5	E5	E6									E2		

How to Use This Table

- Identify TJI® joist and depth.
- Locate the **Roof Truss Span** (horizontal) that meets or exceeds your condition.
- Identify the cantilever condition (less than 5" or 5" to 24") and locate the **Roof Total Load** and **On-Center Joist Spacing** for your application.
- Scan down to find the appropriate cantilever detail and refer to drawing on page 10:
 - Blank cells indicate that no reinforcement is required.
 - E4 may be used in place of E2 or E3 except when using TJI® 560 joists.
 - X indicates that cantilever will not work. Use ForteWEB® and Javelin® software, or reduce spacing of joists and recheck table.

General Notes

- Table is based on:
 - 15 psf roof dead load on a horizontal projection.
 - 80 plf exterior wall load with 3'-0" maximum width window or door openings. For larger openings, or multiple 3'-0" width openings spaced less than 6'-0" on-center, additional joists beneath the opening's trimmers may be required.
 - Floor load of 40 psf live load and 10 psf dead load.
 - More restrictive of simple or continuous span.
 - Roof truss with 24" soffits.
- ¾" reinforcement refers to ¾" Exposure 1 plywood or other ¾" Exposure 1, 48/24-rated sheathing that is cut to match the full depth of the TJI® joist. Install with face grain horizontal. Reinforcing member must bear fully on the wall plate.
- Designed for 2x4 and 2x6 plate widths.
- For conditions beyond the scope of this table, including cantilevers longer than 24", use our ForteWEB® and Javelin® software.

See page 10 for cantilever details

Maximum Horizontal Clear Spans—Roof

O.C. Spacing	Depth	TJI®	Design Live Load (LL) and Dead Load (DL) in PSF											
			Non-Snow (125%)						Snow Load Area (115%)					
			20LL + 15DL		20LL + 20DL		25LL + 15DL		30LL + 15DL		40LL + 15DL		50LL + 15DL	
			Low	High	Low	High	Low	High	Low	High	Low	High	Low	High
16"	9½"	110	20'-0"	17'-10"	19'-1"	16'-11"	19'-2"	17'-2"	18'-5"	16'-7"	17'-2"	15'-7"	15'-11"	14'-9"
		210	21'-2"	18'-10"	20'-2"	17'-10"	20'-3"	18'-2"	19'-6"	17'-6"	18'-2"	16'-6"	17'-2"	15'-7"
		230	21'-11"	19'-6"	20'-10"	18'-6"	20'-11"	18'-9"	20'-2"	18'-1"	18'-10"	17'-0"	17'-9"	16'-2"
	11⅞"	110	23'-11"	21'-4"	22'-9"	20'-2"	22'-8"	20'-6"	21'-5"	19'-10"	19'-5"	18'-7"	17'-11"	17'-4"
		210	25'-3"	22'-6"	24'-1"	21'-4"	24'-2"	21'-8"	23'-3"	20'-11"	21'-4"	19'-8"	19'-8"	18'-8"
		230	26'-1"	23'-3"	24'-10"	22'-0"	24'-11"	22'-4"	24'-0"	21'-7"	22'-5"	20'-4"	20'-9"	19'-3"
		360	27'-9"	24'-9"	26'-5"	23'-5"	26'-7"	23'-10"	25'-6"	23'-0"	23'-11"	21'-7"	22'-7"	20'-6"
		560	31'-11"	28'-6"	30'-5"	27'-0"	30'-7"	27'-5"	29'-5"	26'-5"	27'-6"	24'-10"	26'-0"	23'-7"
		110	27'-2"	24'-3"	25'-7"	23'-0"	24'-9"	23'-4"	23'-4"	22'-4"	21'-2"	20'-5"	19'-6"	18'-11"
	14"	210	28'-9"	25'-7"	27'-4"	24'-3"	27'-1"	24'-8"	25'-7"	23'-9"	23'-3"	22'-4"	21'-5"	20'-9"
		230	29'-8"	26'-6"	28'-3"	25'-1"	28'-5"	25'-5"	27'-0"	24'-7"	24'-6"	23'-1"	22'-7"	21'-10"
		360	31'-6"	28'-2"	30'-0"	26'-8"	30'-2"	27'-1"	29'-0"	26'-1"	27'-2"	24'-7"	25'-8"	23'-4"
560		36'-3"	32'-4"	34'-6"	30'-7"	34'-8"	31'-1"	33'-4"	30'-0"	31'-2"	28'-3"	29'-6"	26'-9"	
110		29'-5"	26'-11"	27'-5"	25'-6"	26'-5"	25'-2"	25'-0"	23'-10"	22'-8"	21'-10"	20'-5"	20'-3"	
210		31'-10"	28'-5"	30'-0"	26'-11"	29'-0"	27'-4"	27'-5"	26'-2"	24'-10"	23'-11"	22'-8"	22'-2"	
16"	230	32'-10"	29'-4"	31'-4"	27'-9"	30'-7"	28'-11"	28'-11"	27'-3"	26'-2"	25'-3"	24'-2"	23'-5"	
	360	34'-11"	31'-2"	33'-3"	29'-6"	33'-5"	30'-0"	32'-2"	28'-11"	30'-1"	27'-2"	26'-0"	25'-10"	
	560	40'-1"	35'-9"	38'-2"	33'-11"	38'-4"	34'-5"	36'-11"	33'-2"	34'-6"	31'-3"	31'-8"	29'-8"	
	110	18'-9"	16'-9"	17'-11"	15'-10"	18'-0"	16'-1"	17'-3"	15'-7"	15'-9"	14'-7"	14'-6"	13'-10"	
	210	19'-10"	17'-9"	18'-11"	16'-9"	19'-0"	17'-0"	18'-3"	16'-5"	17'-1"	15'-5"	15'-11"	14'-8"	
	230	20'-7"	18'-4"	19'-7"	17'-4"	19'-8"	17'-7"	18'-11"	17'-0"	17'-8"	16'-0"	16'-8"	15'-2"	
19.2"	9½"	110	22'-5"	20'-0"	21'-5"	19'-0"	20'-9"	19'-3"	19'-7"	18'-7"	17'-9"	17'-1"	16'-4"	15'-10"
		210	23'-9"	21'-2"	22'-7"	20'-0"	22'-8"	20'-4"	21'-5"	19'-8"	19'-6"	18'-6"	17'-11"	17'-4"
		230	24'-6"	21'-10"	23'-4"	20'-8"	23'-5"	21'-0"	22'-6"	20'-3"	20'-6"	19'-1"	18'-11"	18'-1"
	11⅞"	360	26'-1"	23'-3"	24'-10"	22'-0"	24'-11"	22'-4"	24'-0"	21'-7"	22'-5"	20'-3"	21'-2"	19'-3"
		560	30'-0"	26'-9"	28'-7"	25'-4"	28'-8"	25'-9"	27'-7"	24'-10"	25'-9"	23'-4"	24'-4"	22'-2"
		110	25'-1"	22'-10"	23'-4"	21'-7"	22'-7"	21'-5"	21'-4"	20'-4"	19'-4"	18'-7"	17'-0"	17'-3"
		210	27'-0"	24'-1"	25'-7"	22'-10"	24'-9"	23'-2"	23'-4"	22'-4"	21'-2"	20'-5"	18'-10"	18'-11"
		230	27'-10"	24'-10"	26'-6"	23'-7"	26'-1"	23'-11"	24'-7"	23'-1"	22'-4"	21'-6"	20'-7"	19'-11"
		360	29'-7"	26'-5"	28'-2"	25'-0"	28'-4"	25'-5"	27'-3"	24'-6"	25'-6"	23'-1"	21'-7"	21'-8"
	16"	560	34'-0"	30'-4"	32'-5"	28'-9"	32'-7"	29'-2"	31'-4"	28'-2"	29'-3"	26'-6"	26'-5"	25'-2"
		110	26'-10"	25'-4"	25'-0"	23'-5"	24'-2"	22'-11"	22'-10"	21'-9"	20'-1"	19'-11"	17'-0"	18'-3"
		210	29'-5"	26'-8"	27'-5"	25'-4"	26'-5"	25'-2"	25'-0"	23'-11"	22'-3"	21'-10"	18'-10"	20'-2"
230		30'-11"	27'-7"	28'-11"	26'-1"	27'-11"	26'-6"	26'-4"	25'-2"	23'-11"	23'-0"	21'-2"	21'-8"	
360		32'-10"	29'-3"	31'-3"	27'-9"	31'-5"	28'-2"	30'-2"	27'-2"	25'-7"	25'-3"	21'-7"	21'-8"	
560		37'-8"	33'-7"	35'-10"	31'-10"	36'-0"	32'-4"	34'-8"	31'-2"	31'-3"	29'-4"	26'-5"	25'-5"	
24"	9½"	110	17'-5"	15'-6"	16'-7"	14'-8"	16'-5"	14'-11"	15'-6"	14'-5"	14'-1"	13'-6"	13'-0"	12'-7"
		210	18'-5"	16'-5"	17'-6"	15'-6"	17'-7"	15'-6"	16'-11"	15'-3"	15'-5"	14'-4"	14'-3"	13'-7"
		230	19'-0"	17'-0"	18'-1"	16'-1"	18'-2"	16'-4"	17'-6"	15'-9"	16'-3"	14'-10"	15'-0"	14'-0"
	11⅞"	110	20'-7"	18'-7"	19'-2"	17'-7"	18'-6"	17'-7"	17'-6"	16'-8"	15'-10"	15'-3"	13'-7"	14'-2"
		210	21'-11"	19'-7"	20'-11"	18'-7"	20'-4"	18'-10"	19'-2"	18'-2"	17'-5"	16'-9"	15'-0"	15'-6"
		230	22'-8"	20'-3"	21'-7"	19'-2"	21'-5"	19'-5"	20'-3"	18'-9"	18'-4"	17'-8"	16'-11"	16'-4"
		360	24'-1"	21'-6"	23'-0"	20'-5"	23'-1"	20'-8"	22'-2"	20'-0"	20'-5"	18'-9"	17'-3"	17'-4"
		560	27'-9"	24'-9"	26'-5"	23'-6"	26'-7"	23'-10"	25'-6"	23'-0"	23'-10"	21'-7"	21'-1"	20'-3"
		110	22'-5"	21'-1"	20'-10"	19'-6"	20'-2"	19'-2"	19'-0"	18'-2"	16'-0"	16'-7"	13'-7"	14'-7"
	14"	210	24'-7"	22'-4"	22'-11"	21'-1"	22'-1"	21'-0"	20'-10"	19'-11"	17'-10"	18'-3"	15'-0"	16'-1"
		230	25'-9"	23'-0"	24'-1"	21'-10"	23'-4"	22'-2"	22'-0"	21'-0"	20'-9"	19'-3"	16'-11"	17'-0"
		360	27'-5"	24'-6"	26'-1"	23'-2"	26'-3"	23'-6"	25'-0"	22'-8"	20'-5"	20'-2"	17'-3"	17'-4"
560		31'-6"	28'-1"	30'-0"	26'-8"	30'-2"	27'-0"	29'-0"	26'-1"	24'-11"	23'-7"	21'-1"	20'-3"	
110		24'-0"	22'-8"	22'-4"	20'-11"	21'-7"	20'-6"	19'-8"	19'-6"	16'-0"	16'-11"	13'-7"	14'-7"	
210		26'-3"	24'-9"	24'-6"	22'-11"	23'-8"	22'-6"	21'-9"	21'-4"	17'-10"	18'-9"	15'-0"	16'-1"	
16"	230	27'-9"	25'-6"	25'-10"	24'-2"	24'-11"	23'-8"	23'-7"	22'-6"	20'-0"	19'-9"	16'-11"	17'-0"	
	360	30'-4"	27'-1"	28'-11"	25'-8"	28'-2"	26'-1"	25'-0"	24'-1"	20'-5"	20'-2"	17'-3"	17'-4"	
	560	34'-10"	31'-2"	33'-2"	29'-6"	33'-4"	29'-11"	30'-6"	28'-3"	24'-11"	23'-7"	21'-1"	20'-3"	

How to Use This Table

- Determine appropriate live and dead load, and the load duration factor.
- If your slope is 6:12 or less, use the **Low** slope column. If it is between 6:12 and 12:12, use the **High** column.
- Scan down the column until you find a span that meets or exceeds the span of your application.
- Select TJI® joist and on-center spacing.

General Notes

- Table is based on:
 - Minimum bearing length of 1¾" end and 3½" intermediate, without web stiffeners.
 - Uniform loads.
 - More restrictive of simple or continuous span.
 - Minimum roof slope of ¼:12.
- Total load values are limited to deflection of L/180 and live load is based on joist deflection of L/240.
- For continuous spans, ratio of short span to long span should be 0.4 or greater to prevent uplift.
- A support beam or wall at the high end is required. Ridge board applications do not provide adequate support.
- For flat roofs or other loading conditions not shown, refer to Weyerhaeuser software.

ROOF LOAD TABLE

9½" - 16" JOISTS

Roof—115% and 125% Load Duration (PLF)

Depth	TJI®	Total Load		Defl.	Total Load		Defl.	Total Load		Defl.	Total Load		Defl.	Total Load		Defl.	Total Load		Defl.
		Snow 115%	Non-Snow 125%	Live Load L/240	Snow 115%	Non-Snow 125%	Live Load L/240	Snow 115%	Non-Snow 125%	Live Load L/240	Snow 115%	Non-Snow 125%	Live Load L/240	Snow 115%	Non-Snow 125%	Live Load L/240	Snow 115%	Non-Snow 125%	Live Load L/240
		Roof Joist Horizontal Clear Span																	
		6'			8'			10'			12'			14'			16'		
9½"	110	289	314	*	218	237	*	175	190	*	146	159	*	114	124	112	88	95	77
	210	321	349	*	242	263	*	194	211	*	162	176	*	137	149	130	105	115	90
	230	360	392	*	272	295	*	218	237	*	182	198	*	153	166	143	117	127	99
11½"	110	289	314	*	218	237	*	175	190	*	146	159	*	125	136	*	110	119	*
	210	321	349	*	242	263	*	194	211	*	162	176	*	139	151	*	122	132	*
	230	360	392	*	272	295	*	218	237	*	182	198	*	156	170	*	137	149	*
	360	368	400	*	277	301	*	223	242	*	186	202	*	159	173	*	140	152	*
	560	449	488	*	338	368	*	272	295	*	227	246	*	195	212	*	170	185	*
14"	110	289	314	*	218	237	*	175	190	*	146	159	*	125	136	*	110	119	*
	210	321	349	*	242	263	*	194	211	*	162	176	*	139	151	*	122	132	*
	230	360	392	*	272	295	*	218	237	*	182	198	*	156	170	*	137	149	*
	360	368	400	*	277	301	*	223	242	*	186	202	*	159	173	*	140	152	*
	560	449	488	*	338	368	*	272	295	*	227	246	*	195	212	*	170	185	*
16"	110	289	314	*	218	237	*	175	190	*	146	159	*	125	136	*	110	119	*
	210	321	349	*	242	263	*	194	211	*	162	176	*	139	151	*	122	132	*
	230	360	392	*	272	295	*	218	237	*	182	198	*	156	170	*	137	149	*
	360	368	400	*	277	301	*	223	242	*	186	202	*	159	173	*	140	152	*
	560	449	488	*	338	368	*	272	295	*	227	246	*	195	212	*	170	185	*
		18'			20'			22'			24'			26'			28'		
9½"	110																		
	210	83	86	64															
	230	93	94	71															
11½"	110	88	95	91		77	68												
	210	106	115	106	86	93	79		77	60									
	230	117	128	116	95	103	86	79	85	66									
	360	124	135	*	112	122	103	102	105	78	82	82	61						
	560	152	165	*	137	148	*	124	135	117	114	122	91	97	97	73	79	79	59
14"	110	98	106	*	84	92	*		76	75									
	210	108	118	*	97	106	*	84	91	87		77	68						
	230	122	132	*	110	119	*	93	101	95	78	85	74						
	360	124	135	*	112	122	*	102	111	*	93	101	88	86	94	70	76	76	57
	560	152	165	*	137	148	*	124	135	*	114	124	*	105	114	104	98	106	85
16"	110	98	106	*	88	96	*	80	87	*									
	210	108	118	*	97	106	*	89	96	*	81	88	*		75	73			
	230	122	132	*	110	119	*	100	108	*	90	97	*	76	83	79			
	360	124	135	*	112	122	*	102	111	*	93	101	*	86	94	*	80	87	76
	560	152	165	*	137	148	*	124	135	*	114	124	*	105	114	*	98	106	*

* Indicates that Total Load value controls.

Slope Factors

Slope	2½:12	3:12	3½:12	4:12	4½:12	5:12	6:12	7:12	8:12	9:12	10:12	11:12	12:12
Factor	1.021	1.031	1.042	1.054	1.068	1.083	1.118	1.158	1.202	1.250	1.302	1.357	1.414

How to Use These Tables

1. Calculate actual total load in pounds per linear foot (plf).
2. Select appropriate **Roof Joist Horizontal Clear Span**. For slopes greater than 2:12, approximate the increased dead load by multiplying the joist horizontal clear span by the **Slope Factor** above.
3. Scan down the column to find a TJI® joist that meets or exceeds actual total load.

General Notes

- Tables are based on:
 - Minimum bearing length of 1¾" end and 3½" intermediate, without web stiffeners.
 - Uniform loads.
 - More restrictive of simple or continuous span.
 - Minimum roof slope of ¼:12.
- **Total Load** values are limited to deflection of L/180. For stiffer deflection criteria, use the **Live Load L/240** values.

FRAMING CONNECTORS (SIMPSON STRONG-TIE®)



Single Joist, Top Mount



Single Joist, Face Mount

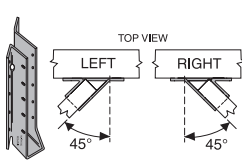

Face Mount Skewed 45° Joist Hanger

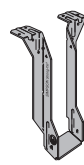

Double Joist, Top Mount



Double Joist, Face Mount

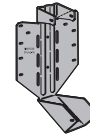

Variable Slope Seat Joist Hanger

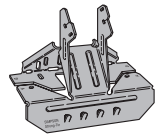

Variable Slope Seat Connector

Joist Depth	TJI®	Single Joist—Top Mount				Single Joist—Face Mount				Face Mount Skewed 45° Joist Hanger ⁽¹⁾			
		Hanger	Capacity (lbs)	Nailing		Hanger	Capacity (lbs)	Nailing		Hanger	Capacity (lbs)	Nailing	
				Header	Joist			Header	Joist			Header	Joist
9½"	110	ITS1.81/9.5	975	10d	N.A.	IUS1.81/9.5	950	10d	N.A.	SUR/L1.81/9	1,220	16d	10d x 1½"
	210	ITS2.06/9.5	1,070	10d	N.A.	IUS2.06/9.5	950	10d	N.A.	SUR/L2.1/9	1,330	16d	10d x 1½"
	230	ITS2.37/9.5	1,120	10d	N.A.	IUS2.37/9.5	950	10d	N.A.	SUR/L2.37/9	1,330	16d	10d x 1½"
11⅝"	110	ITS1.81/11.88	975	10d	N.A.	IUS1.81/11.88 ⁽¹⁾	975	10d	N.A.	SUR/L1.81/11	1,240	16d	10d x 1½"
	210	ITS2.06/11.88	1,070	10d	N.A.	IUS2.06/11.88 ⁽¹⁾	1,070	10d	N.A.	SUR/L2.1/11	1,380	16d	10d x 1½"
	230	ITS2.37/11.88	1,120	10d	N.A.	IUS2.37/11.88 ⁽¹⁾	1,120	10d	N.A.	SUR/L2.37/11	1,410	16d	10d x 1½"
	360	ITS2.37/11.88	1,140	10d	N.A.	IUS2.37/11.88 ⁽¹⁾	1,140	10d	N.A.	SUR/L2.37/11	1,430	16d	10d x 1½"
	560	ITS3.56/11.88 ⁽⁶⁾	1,150	10d	N.A.	IUS3.56/11.88 ⁽¹⁾⁽⁶⁾	1,150	10d	N.A.	SUR/L410	1,495	16d	16d
14"	110	ITS1.81/14	975	10d	N.A.	IUS1.81/14 ⁽¹⁾	975	10d	N.A.	SUR/L1.81/14	1,240	16d	10d x 1½"
	210	ITS2.06/14	1,070	10d	N.A.	IUS2.06/14 ⁽¹⁾	1,070	10d	N.A.	SUR/L2.1/14	1,380	16d	10d x 1½"
	230	ITS2.37/14	1,120	10d	N.A.	IUS2.37/14 ⁽¹⁾	1,120	10d	N.A.	SUR/L2.37/14	1,410	16d	10d x 1½"
	360	ITS2.37/14	1,140	10d	N.A.	IUS2.37/14 ⁽¹⁾	1,140	10d	N.A.	SUR/L2.37/14	1,430	16d	10d x 1½"
	560	ITS3.56/14 ⁽⁶⁾	1,150	10d	N.A.	IUS3.56/14 ⁽¹⁾⁽⁶⁾	1,150	10d	N.A.	SUR/L414	1,495	16d	16d
16"	110	ITS1.81/16	975	10d	N.A.	IUS1.81/16 ⁽¹⁾	975	10d	N.A.	SUR/L1.81/14	1,240	16d	10d x 1½"
	210	ITS2.06/16	1,070	10d	N.A.	IUS2.06/16 ⁽¹⁾	1,070	10d	N.A.	SUR/L2.1/14	1,380	16d	10d x 1½"
	230	ITS2.37/16	1,120	10d	N.A.	IUS2.37/16 ⁽¹⁾	1,120	10d	N.A.	SUR/L2.37/14	1,410	16d	10d x 1½"
	360	ITS2.37/16	1,140	10d	N.A.	IUS2.37/16 ⁽¹⁾	1,140	10d	N.A.	SUR/L2.37/14	1,430	16d	10d x 1½"
	560	ITS3.56/16 ⁽⁶⁾	1,150	10d	N.A.	IUS3.56/16 ⁽¹⁾⁽⁶⁾	1,150	10d	N.A.	SUR/L414	1,495	16d	16d

Joist Depth	TJI®	Double Joist—Top Mount				Double Joist—Face Mount			
		Hanger	Capacity (lbs)	Nailing		Hanger	Capacity (lbs)	Nailing	
				Header	Joist			Header	Joist
9½"	110	MIT49.5	2,115	16d	10d x 1½"	MIU3.56/9⁽¹⁾	2,215	16d	10d x 1½"
	210	MIT4.28/9.5	2,115	16d	10d x 1½"	MIU4.28/9	2,305	16d	10d x 1½"
	230	MIT359.5-2	2,115	16d	10d x 1½"	MIU4.75/9	2,305	16d	10d x 1½"
11⅝"	110	MIT411.88	2,115	16d	10d x 1½"	MIU3.56/11⁽¹⁾	2,215	16d	10d x 1½"
	210	MIT4.28/11.88	2,115	16d	10d x 1½"	MIU4.28/11⁽¹⁾	2,395	16d	10d x 1½"
	230	MIT3511.88-2	2,115	16d	10d x 1½"	MIU4.75/11⁽¹⁾	2,490	16d	10d x 1½"
	360	MIT3511.88-2	2,115	16d	10d x 1½"	MIU4.75/11	2,525	16d	10d x 1½"
	560	HB7.12/11.88	3,450	16d	16d	HU412-2	2,380	16d	16d
14"	110	MIT414	2,115	16d	10d x 1½"	MIU3.56/14⁽¹⁾	2,215	16d	10d x 1½"
	210	MIT4.28/14	2,115	16d	10d x 1½"	MIU4.28/14⁽¹⁾	2,395	16d	10d x 1½"
	230	MIT3514-2	2,115	16d	10d x 1½"	MIU4.75/14⁽¹⁾	2,490	16d	10d x 1½"
	360	MIT3514-2	2,115	16d	10d x 1½"	MIU4.75/14⁽¹⁾	2,525	16d	10d x 1½"
	560	HB7.12/14	3,450	16d	16d	HU414-2	2,925	16d	16d
16"	110	MIT416	2,115	16d	10d x 1½"	MIU3.56/16⁽¹⁾	2,215	16d	10d x 1½"
	210	BA4.28/16	2,655	16d	10d x 1½"	MIU4.28/16⁽¹⁾	2,395	16d	10d x 1½"
	230	MIT4.75/16	2,115	16d	10d x 1½"	MIU4.75/16⁽¹⁾	2,490	16d	10d x 1½"
	360	MIT4.75/16	2,115	16d	10d x 1½"	MIU4.75/16⁽¹⁾	2,525	16d	10d x 1½"
	560	HB7.12/16	3,450	16d	16d	HU414-2	2,925	16d	16d

Joist Depth	TJI®	Variable Slope Seat Joist Hanger ⁽³⁾			
		Hanger	Capacity (lbs)		Nailing
		Sloped Only ⁽¹⁾	Sloped and Skewed	Header	Joist
110	LSSR1.81Z	945	945	10d	10d x 1½"
210	LSSR2.1Z	1,035	1,035	10d	10d x 1½"
230	LSSR2.37Z	1,090	1,060	10d	10d x 1½"
360	LSSR2.37Z	1,110	1,060	10d	10d x 1½"
560	LSSR410Z	1,300	1,300	16d	16d

Joist Depth	TJI®	Variable Slope Seat Connector ⁽²⁾			
		Hanger	Capacity (lbs)	Nailing	
				Header	Joist
110	VPA25	975	10d	10d x 1½"	
210	VPA2.1	1,070	10d	10d x 1½"	
230	VPA35	1,120	10d	10d x 1½"	
360	VPA35	1,140	10d	10d x 1½"	
560	VPA4	1,245	10d	10d x 1½"	

General Notes

Bold italic hangers require web stiffeners.

Capacities will vary with different nailing criteria or other support conditions; contact your Weyerhaeuser representative for assistance.

- Hanger capacities shown are either joist bearing capacity or hanger capacity—whichever is less. Joist end reaction must be checked to ensure it does not exceed the capacity shown in the tables.
- All capacities are for downward loads at 100% duration of load.
- Fill all round, dimple, and positive-angle nail holes.
- Use sloped seat hangers and beveled web stiffeners when TJI® joist slope exceeds ¼:12.
- Leave ⅛" clearance (⅜" maximum) between the end of the supported joist and the header or hanger.
- Nails: 16d = 0.162" x 3½", 10d = 0.148" x 3", and 10d x 1½" = 0.148" x 1½".

Support Requirements

- Support material assumed to be Trus Joist® engineered lumber or sawn lumber (Douglas fir or southern pine species).
- Minimum support width for single- and double-joist top mount hangers is 3" (1½" for ITS hangers).
- Minimum support width for face mount hangers with 10d and 16d nails (clinched) is 1½" and 1¾", respectively.

Also see table footnotes on page 15

FRAMING CONNECTORS (USP STRUCTURAL CONNECTORS)

9½" - 16"
JOISTS

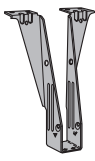

Single Joist, Top Mount

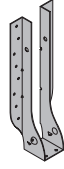

Single Joist, Face Mount

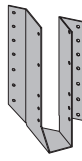

Face Mount Skewed 45° Joist Hanger

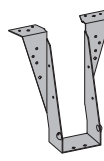

Double Joist, Top Mount

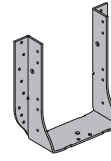

Double Joist, Face Mount

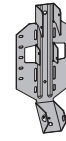

Variable Slope Seat Joist Hanger

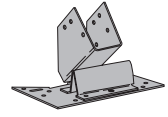

Variable Slope Seat Connector

Joist Depth	TJI®	Single Joist—Top Mount				Single Joist—Face Mount				Face Mount Skewed 45° Joist Hanger ⁽¹⁾			
		Hanger	Capacity (lbs)	Nailing		Hanger	Capacity (lbs)	Nailing		Hanger	Capacity (lbs)	Nailing	
				Header	Joist			Header	Joist			Header	Joist
9½"	110	TH017950	975	10d	10d x 1½"	IHFL17925	960	10d	N.A.	SKH1720L/R	945	10d	10d x 1½"
	210	TFL2095	1,070	10d	10d x 1½"	IHFL20925	960	10d	N.A.	SKH2020L/R	1,035	10d	10d x 1½"
	230	TFL2395	1,120	10d	10d x 1½"	IHFL23925	960	10d	N.A.	SKH2320L/R	1,090	10d	10d x 1½"
11½"	110	TH017118	975	10d	10d x 1½"	IHFL17112 ⁽¹⁾	1,105	10d	N.A.	SKH1720L/R	945	10d	10d x 1½"
	210	TFL20118	1,070	10d	10d x 1½"	IHFL20112	1,200	10d	N.A.	SKH2020L/R	1,035	10d	10d x 1½"
	230	TFL23118	1,120	10d	10d x 1½"	IHFL23112	1,200	10d	N.A.	SKH2320L/R	1,090	10d	10d x 1½"
	360	TFL23118	1,140	10d	10d x 1½"	IHFL23112	1,200	10d	N.A.	SKH2320L/R	1,110	10d	10d x 1½"
	560	TH035118	1,430	10d	10d x 1½"	IHFL35112	1,200	10d	N.A.	SKH410L/R ⁽⁴⁾	1,460	16d	16d
14"	110	TFL1714	975	10d	10d x 1½"	IHFL1714 ⁽¹⁾	1,105	10d	N.A.	SKH1720L/R	945	10d	10d x 1½"
	210	TFL2014	1,070	10d	10d x 1½"	IHFL2014 ⁽¹⁾	1,200	10d	N.A.	SKH2020L/R	1,035	10d	10d x 1½"
	230	TFL2314	1,120	10d	10d x 1½"	IHFL2314 ⁽¹⁾	1,245	10d	N.A.	SKH2324L/R	1,090	10d	10d x 1½"
	360	TFL2314	1,140	10d	10d x 1½"	IHFL2314 ⁽¹⁾	1,265	10d	N.A.	SKH2324L/R	1,110	10d	10d x 1½"
	560	TH035140	1,430	10d	10d x 1½"	IHFL3514	1,440	10d	N.A.	SKH414L/R ⁽⁴⁾	1,460	16d	16d
16"	110	TFL1716	975	10d	10d x 1½"	IHFL1716 ⁽¹⁾	1,105	10d	N.A.	SKH1724L/R	945	10d	10d x 1½"
	210	TFL2016	1,070	10d	10d x 1½"	IHFL2016 ⁽¹⁾	1,200	10d	N.A.	SKH2024L/R	1,035	10d	10d x 1½"
	230	TFL2316	1,120	10d	10d x 1½"	IHFL2316 ⁽¹⁾	1,245	10d	N.A.	SKH2324L/R	1,090	10d	10d x 1½"
	360	TFL2316	1,140	10d	10d x 1½"	IHFL2316 ⁽¹⁾	1,265	10d	N.A.	SKH2324L/R	1,110	10d	10d x 1½"
	560	TH035160	1,430	10d	10d x 1½"	IHFL3516 ⁽¹⁾	1,460	10d	N.A.	SKH414L/R ⁽⁴⁾	1,460	16d	16d

Joist Depth	TJI®	Double Joist—Top Mount				Double Joist—Face Mount			
		Hanger	Capacity (lbs)	Nailing		Hanger	Capacity (lbs)	Nailing	
				Header	Joist			Header	Joist
9½"	110	TH035950	2,150	10d	10d x 1½"	IHF35925	1,250	10d	10d x 1½"
	210	TH020950-2	2,655	16d	10d	IHF20925-2	1,250	10d	10d x 1½"
	230	TH023950-2	2,660	16d	10d	IHF23925-2	1,250	10d	10d x 1½"
11½"	110	TH035118	2,150	10d	10d x 1½"	IHF35112	1,250	10d	10d x 1½"
	210	TH020118-2	2,655	16d	10d	IHF20112-2	1,250	10d	10d x 1½"
	230	TH023118-2	2,730	16d	10d	THF23118-2	1,890	10d	10d
	360	TH023118-2	2,770	16d	10d	THF23118-2	1,890	10d	10d
	560	BPH71118	3,075	16d	10d	HD7120	2,465	16d	16d
14"	110	TH035140	2,150	10d	10d x 1½"	IHF3514	1,500	10d	10d x 1½"
	210	TH020140-2	2,655	16d	10d	IHF2014-2	1,500	10d	10d x 1½"
	230	TH023140-2	2,730	16d	10d	THF23140-2	2,490	10d	10d
	360	TH023140-2	2,770	16d	10d	THF23140-2	2,525	10d	10d
	560	BPH7114	3,075	16d	10d	HD7140	2,925	16d	16d
16"	110	TH035160	2,150	10d	10d x 1½"	IHF3516	1,750	10d	10d x 1½"
	210	TH020160-2	2,655	16d	10d	IHF2014-2	1,500	10d	10d x 1½"
	230	TH023160-2	2,730	16d	10d	THF23160-2	2,490	10d	10d
	360	TH023160-2	2,770	16d	10d	THF23160-2	2,525	10d	10d
	560	BPH7116	3,075	16d	10d	HD7140	2,925	16d	16d

Hanger information on these two pages was provided by either Simpson Strong-Tie® or USP Structural Connectors®. For additional information, please refer to their literature.

Table footnotes for pages 14 and 15:

- (1) Face mount and LSSR hanger capacities may be increased up to 15% for snow roofs or 25% for non-snow roofs.
- (2) VPA connectors are allowed on slopes of 3:12 through 12:12 only.
- (3) LSSR and LSSH hangers can be field adjusted for slopes and skews of up to 45 degrees. Additional lateral restraints are required for 16" deep TJI® joists.
- (4) Miter cut is required at end of joist.
- (5) TMP connectors are allowed on slopes of 1:12 through 6:12 only, and TMPH connectors are allowed on slopes of 6:12 through 12:12 only.
- (6) Capacity may be increased to 1,330 lbs if web stiffeners are used.

See General Notes on page 14

Joist Depth	TJI®	Variable Slope Seat Joist Hanger ⁽³⁾				
		Hanger	Capacity (lbs)		Nailing	
			Sloped Only	Sloped and Skewed	Header	Joist
110	LSSH179	1,200	1,200	10d	10d x 1½"	
210	LSSH20	1,200	1,200	10d	10d x 1½"	
230	LSSH23	1,200	1,200	10d	10d x 1½"	
360	LSSH23	1,200	1,200	10d	10d x 1½"	
560	LSSH35	1,595	1,595	16d	10d x 1½"	

Joist Depth	TJI®	Variable Slope Seat Connector ⁽⁵⁾			
		Hanger	Capacity (lbs)	Nailing	
				Header	Joist
110	TMP175	1,220	10d	10d x 1½"	
	TMPH175	1,220	10d	10d x 1½"	
210	TMP21	1,330	10d	10d x 1½"	
	TMPH21	1,330	10d	10d x 1½"	
230	TMP23	1,330	10d	10d x 1½"	
	TMPH23	1,330	10d	10d x 1½"	
360	TMP23	1,505	10d	10d x 1½"	
	TMPH23	1,505	10d	10d x 1½"	
560	TMP4	1,705	10d	10d x 1½"	
	TMPH4	1,725	10d	10d x 1½"	

SECTION 2: 18" - 24" TJI® JOISTS

This section contains design information for 18" - 24" deep Trus Joist® TJI® joists used in residential, multi-family, or light-commercial applications.

18" - 20" deep TJI® joists are readily available through your local Weyerhaeuser dealer or distributor. Offered with the flange sizes shown below, they come in lengths up to 60' (in 1' increments). 22" and 24" deep TJI® joists are only available in some regions; for more information, contact your Weyerhaeuser representative.

Design Properties (100% Load Duration)

Depth	TJI	Basic Properties				Reaction Properties					
		Joist Weight (lbs/ft)	Maximum Resistive Moment ⁽¹⁾ (ft-lbs)	Joist Only EI x 10 ⁶ (lbs-in. ²)	Maximum Vertical Shear (lbs)	1¾" End Reaction (lbs)		3½" Intermediate Reaction (lbs)		5¼" Intermediate Reaction (lbs)	
						No Web Stiffeners	With Web Stiffeners ⁽²⁾	No Web Stiffeners	With Web Stiffeners ⁽²⁾	No Web Stiffeners	With Web Stiffeners ⁽²⁾
18"	360	3.7	9,465	1,085	2,425	1,080	1,440	2,460	2,815	3,000	3,360
	560	4.8	14,550	1,631	3,030	1,265	1,740	3,000	3,475	3,455	3,930
	560D	5.0	14,785	1,661	3,080	1,400	2,030	3,350	3,980	3,965	4,600
20"	360	4.0	10,515	1,376	2,660	1,080	1,440	2,460	2,815	3,000	3,360
	560	5.1	16,165	2,064	3,345	1,265	1,740	3,000	3,475	3,455	3,930
	560D	5.3	16,435	2,105	3,345	1,400	2,190	3,350	4,140	3,965	4,755
22"	560D	5.6	18,075	2,606	3,615	NA ⁽³⁾	2,345	NA ⁽³⁾	5,090	NA ⁽³⁾	5,705
24"	560D	5.8	19,700	3,165	3,400	NA ⁽³⁾	2,345	NA ⁽³⁾	5,405	NA ⁽³⁾	6,020

(1) Caution: Do not increase joist moment design properties by a repetitive-member-use factor.

(2) See detail W on page 27 for web stiffener requirements and nailing information.

(3) Web stiffeners are required at all bearing locations for 22" and 24" TJI® 560D joists.

General Notes

- Design reaction includes all loads on the joist. Design shear is computed at the inside face of supports and includes all loads on the span(s). Allowable shear may sometimes be increased at interior supports in accordance with ICC-ES ESR-1153, and these increases are reflected in span tables.
- The formulas at right approximate the uniform load deflection of Δ (inches).

TJI® joists are intended for dry-use applications

Some TJI® joist series may not be available in your region. Contact your Weyerhaeuser representative for information.

For TJI® 360 Joists

$$\Delta = \frac{22.5 wL^4}{EI} + \frac{2.67 wL^2}{d \times 10^5}$$

For TJI® 560 and 560D Joists

$$\Delta = \frac{22.5 wL^4}{EI} + \frac{2.29 wL^2}{d \times 10^5}$$

w = uniform load in pounds per linear foot
 L = span in feet
 d = out-to-out depth of the joist in inches
 EI = value from table above

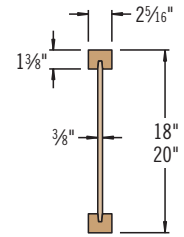

TJI® 360 Joist

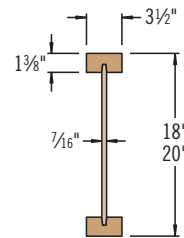

TJI® 560 Joist

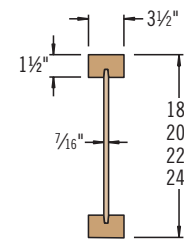

TJI® 560D Joist



DO NOT walk on joists until braced. INJURY MAY RESULT.



DO NOT stack building materials on unsheathed joists. Stack only over beams or walls.



DO NOT walk on joists that are lying flat.

WARNING

Joists are unstable until braced laterally

Bracing Includes:

- Blocking
- Hangers
- Rim Board
- Sheathing
- Rim Joist
- Strut Lines

WARNING NOTES: Lack of proper bracing during construction can result in serious accidents. Observe the following guidelines:

- All blocking, hangers, rim boards, and rim joists at the end supports of the TJI® joists must be completely installed and properly nailed.
- Lateral strength, like a braced end wall or an existing deck, must be established at the ends of the bay. This can also be accomplished by a temporary or permanent deck (sheathing) fastened to the first 4 feet of joists at the end of the bay.
- Safety bracing of 1x4 (minimum) must be nailed to a braced end wall or sheathed area (as in note 2) and to each joist. Without this bracing, buckling sideways or rollover is highly probable under light construction loads—such as a worker or one layer of unnailed sheathing.
- Sheathing must be completely attached to each TJI® joist before additional loads can be placed on the system.
- Ends of cantilevers require safety bracing on both the top and bottom flanges.
- The flanges must remain straight within a tolerance of ½" from true alignment.

L/480 Live Load Deflection

Depth	TJI®	40 PSF Live Load / 10 PSF Dead Load			40 PSF Live Load / 25 PSF Dead Load		
		16" o.c.	19.2" o.c.	24" o.c.	16" o.c.	19.2" o.c.	24" o.c.
18"	360	28'-8"	26'-10" ⁽¹⁾	21'-5" ⁽¹⁾	24'-9" ⁽¹⁾	20'-7" ⁽¹⁾	16'-6" ⁽¹⁾
	560, 560D	32'-5"	30'-7" ⁽¹⁾	25'-2" ⁽¹⁾	29'-1"⁽¹⁾	24'-2" ⁽¹⁾	19'-4" ⁽¹⁾
20"	360	31'-0" ⁽¹⁾	26'-10" ⁽¹⁾	21'-5" ⁽¹⁾	24'-9" ⁽¹⁾	20'-7" ⁽¹⁾	16'-6" ⁽¹⁾
	560, 560D	35'-1"	31'-6" ⁽¹⁾	25'-2" ⁽¹⁾	29'-1" ⁽¹⁾	24'-2" ⁽¹⁾	19'-4" ⁽¹⁾
22"	560D	37'-11"	35'-9"	33'-2"	37'-11"	35'-9"	31'-2"
24"	560D	40'-6"	38'-1"	35'-5"	40'-6"	38'-1"	33'-1"

L/360 Live Load Deflection (Minimum Criteria per Code)

Depth	TJI®	40 PSF Live Load / 10 PSF Dead Load			40 PSF Live Load / 25 PSF Dead Load		
		16" o.c.	19.2" o.c.	24" o.c.	16" o.c.	19.2" o.c.	24" o.c.
18"	360	31'-9" ⁽¹⁾	26'-10" ⁽¹⁾	21'-5" ⁽¹⁾	24'-9" ⁽¹⁾	20'-7" ⁽¹⁾	16'-6" ⁽¹⁾
	560, 560D	35'-11" ⁽¹⁾	31'-6" ⁽¹⁾	25'-2" ⁽¹⁾	29'-1"⁽¹⁾	24'-2" ⁽¹⁾	19'-4" ⁽¹⁾
20"	360	32'-3" ⁽¹⁾	26'-10" ⁽¹⁾	21'-5" ⁽¹⁾	24'-9" ⁽¹⁾	20'-7" ⁽¹⁾	16'-6" ⁽¹⁾
	560, 560D	37'-10" ⁽¹⁾	31'-6" ⁽¹⁾	25'-2" ⁽¹⁾	29'-1" ⁽¹⁾	24'-2" ⁽¹⁾	19'-4" ⁽¹⁾
22"	560D	42'-0"	39'-7"	36'-10"	40'-8"	37'-2"	31'-2"
24"	560D	44'-9"	42'-3"	39'-3"	42'-6"	38'-9"	33'-1"

(1) Web stiffeners are required at intermediate supports of continuous-span joists when the intermediate bearing length is less than 5¼" and the span on either side of the intermediate bearing is greater than the following spans:

Depth	TJI®	40 PSF Live Load / 10 PSF Dead Load			40 PSF Live Load / 25 PSF Dead Load		
		16" o.c.	19.2" o.c.	24" o.c.	16" o.c.	19.2" o.c.	24" o.c.
18" and 20"	360	29'-4"	24'-5"	19'-6"	22'-7"	18'-9"	15'-0"
	560, 560D	35'-10"	29'-10"	23'-10"	27'-7"	22'-11"	18'-4"

■ Long term deflection under dead load, which includes the effect of creep, has not been considered. ***Bold italic*** spans reflect initial dead load deflection exceeding 0.33".

Live load deflection is not the only factor that affects how a floor will perform. To more accurately predict floor performance, use our TJ-Pro™ Ratings.

How to Use These Tables

1. Determine the appropriate live load deflection criteria.
2. Identify the live and dead load condition.
3. Select on-center spacing and scan down the column until you meet or exceed the span of your application.
5. Select TJI® joist and depth.

General Notes

- Tables are based on:
 - Uniform loads.
 - More restrictive of simple or continuous span.
 - Clear distance between supports
 - **18" and 20" TJI® joists:** Minimum bearing length of 1¾" end (no web stiffeners) and 3½" intermediate.
 - **22" and 24" TJI® joists:** Minimum bearing length of 1¾" end and 3½" intermediate; web stiffeners required at all bearings.
- Assumed composite action with a single layer of 24" on-center span-rated, glue-nailed floor panels for deflection only. **When subfloor adhesive is not applied, spans shall be reduced 6" for nails and 12" for proprietary fasteners.**
- For continuous spans, ratio of short span to long span should be 0.4 or greater to prevent uplift.
- Spans generated from Weyerhaeuser software may exceed the spans shown in these tables because software reflects actual design conditions.
- For multi-family applications and other loading conditions not shown, refer to Weyerhaeuser software or to the load table below.

FLOOR LOAD TABLES

Floor—100% (PLF)

Depth	TJI®	Joist Clear Span											
		8'		10'		12'		14'		16'		18'	
		Live Load L/480	Total Load	Live Load L/480	Total Load	Live Load L/480	Total Load	Live Load L/480	Total Load	Live Load L/480	Total Load	Live Load L/480	Total Load
18"	360	*	241	*	193	*	162	*	139	*	121	*	108
	560, 560D	*	294	*	236	*	197	*	169	*	148	*	132
20"	360	*	241	*	193	*	162	*	139	*	121	*	108
	560, 560D	*	294	*	236	*	197	*	169	*	148	*	132
22"	560D	*	499	*	401	*	335	*	287	*	252	*	224
24"	560D	*	530	*	426	*	356	*	305	*	267	*	238
18"	360	*	97	*	88	76	81	61	75				
	560, 560D	*	119	*	108	*	99	89	91	72	85	60	79
20"	360	*	97	*	88	*	81	*	75				
	560, 560D	*	119	*	108	*	99	*	91	*	85	75	79
22"	560D	*	202	*	183	*	168	137	155	112	144	93	135
24"	560D	*	214	*	195	*	179	164	165	134	153	111	143

* Indicates that Total Load value controls.

How to Use This Table

1. Calculate actual total and live load in pounds per linear foot (plf).
2. Select appropriate **Joist Clear Span**.
3. Scan down the column to find a TJI® joist that meets or exceeds actual total and live loads.

General Notes

- Tables are based on:
 - Uniform loads.
 - No composite action provided by sheathing.
 - More restrictive of simple or continuous span.
 - **18" and 20" TJI® joists:** Minimum bearing length of 1¾" end and 3½" intermediate (no web stiffeners).
 - **22" and 24" TJI® joists:** Minimum bearing length of 1¾" end and 3½" intermediate; web stiffeners required at all bearings.
- **Total Load** values are limited to deflection of L/240.
- **Live Load** is based on joist deflection of L/480.
- If a live load deflection limit of L/360 is desired, multiply value in **Live Load** column by 1.33. The resulting live load must not exceed the **Total Load** shown.
- Table does not account for concentrated loads. Use Weyerhaeuser software when this condition applies.

See page 31 for PSF to PLF Conversion Table

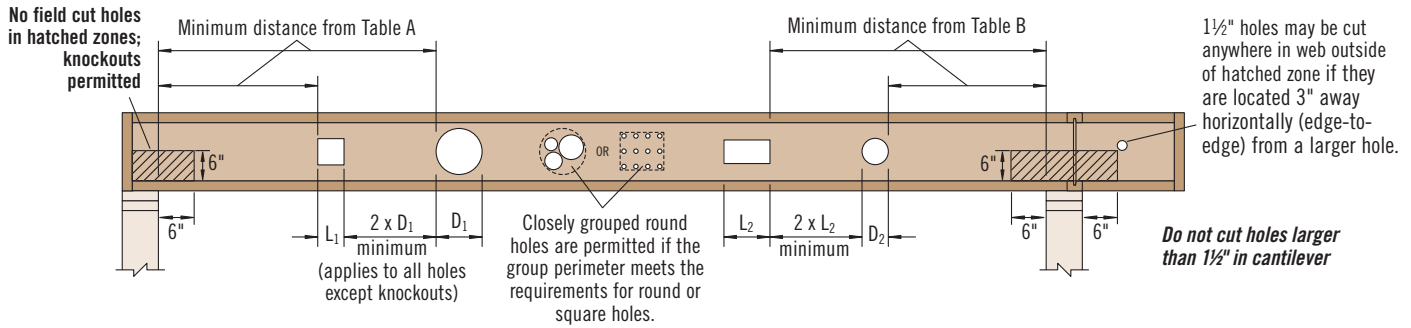

Table A—End Support

Minimum distance from edge of hole to inside face of nearest end support)

Depth	TJI®	● Round Hole Size										■ Square or Rectangular Hole Size									
		4"	6"	7"	8"	10"	12"	14¾"	16¾"	18¾"	20"	4"	6"	7"	8"	10"	12"	14¾"	16¾"	18¾"	20"
18"	360	1'-0"	1'-0"	1'-0"	2'-0"	4'-0"	5'-6"	9'-6"				1'-0"	3'-0"	4'-6"	6'-0"	10'-0"	11'-0"	13'-6"			
	560	1'-0"	1'-0"	1'-0"	2'-0"	4'-6"	7'-0"	10'-6"				2'-0"	5'-0"	6'-6"	8'-0"	11'-0"	12'-0"	14'-0"			
	560D	1'-0"	1'-6"	2'-6"	3'-6"	5'-6"	7'-6"	11'-0"				3'-0"	5'-6"	6'-6"	8'-0"	10'-6"	11'-6"	13'-6"			
20"	360	1'-0"	1'-0"	1'-0"	2'-0"	4'-0"	7'-0"	10'-0"				1'-0"	3'-6"	4'-0"	4'-6"	8'-0"	11'-6"	13'-6"	15'-6"		
	560	1'-0"	1'-0"	1'-0"	2'-0"	4'-6"	8'-6"	11'-0"				1'-0"	3'-6"	5'-0"	7'-0"	10'-6"	13'-0"	14'-6"	15'-6"		
	560D	1'-0"	1'-0"	1'-6"	2'-6"	4'-6"	6'-0"	9'-0"	11'-6"			2'-6"	5'-0"	6'-0"	7'-0"	10'-0"	12'-6"	14'-0"	15'-0"		
22"	560D	1'-0"	1'-0"	1'-0"	1'-6"	3'-6"	5'-0"	7'-0"	9'-6"	12'-6"		1'-0"	3'-6"	5'-0"	6'-6"	14'-6"	15'-0"	16'-0"	16'-6"	17'-0"	
24"	560D	1'-0"	1'-0"	1'-6"	2'-0"	3'-6"	5'-0"	7'-0"	8'-6"	11'-0"	12'-6"	1'-6"	4'-0"	5'-0"	6'-6"	9'-6"	15'-0"	16'-0"	16'-6"	17'-0"	17'-0"

Table B—Intermediate or Cantilever Support

Minimum distance from edge of hole to inside face of nearest intermediate or cantilever support

Depth	TJI®	● Round Hole Size										■ Square or Rectangular Hole Size									
		4"	6"	7"	8"	10"	12"	14¾"	16¾"	18¾"	20"	4"	6"	7"	8"	10"	12"	14¾"	16¾"	18¾"	20"
18"	360	1'-0"	1'-0"	1'-6"	3'-0"	6'-0"	9'-0"	14'-6"				1'-0"	4'-0"	6'-6"	9'-0"	14'-6"	16'-6"	19'-0"			
	560	1'-0"	1'-0"	1'-0"	2'-0"	6'-0"	10'-0"	15'-6"				1'-0"	6'-0"	8'-6"	11'-6"	16'-6"	18'-0"	19'-6"			
	560D	1'-0"	1'-0"	2'-6"	4'-6"	7'-6"	11'-0"	16'-6"				3'-0"	7'-6"	9'-6"	11'-6"	16'-0"	17'-0"	19'-0"			
20"	360	1'-0"	1'-0"	1'-0"	1'-0"	3'-0"	6'-0"	11'-0"	15'-0"			1'-0"	1'-6"	4'-0"	7'-0"	12'-6"	16'-6"	19'-0"	20'-6"		
	560	1'-0"	1'-0"	1'-0"	1'-0"	1'-6"	5'-6"	11'-6"	15'-6"			1'-0"	3'-0"	6'-0"	8'-6"	14'-0"	17'-6"	19'-0"	20'-6"		
	560D	1'-0"	1'-0"	1'-0"	1'-0"	4'-6"	8'-6"	13'-6"	17'-0"			1'-0"	5'-6"	8'-0"	10'-0"	15'-0"	18'-0"	19'-6"	20'-6"		
22"	560D	1'-0"	2'-6"	3'-6"	4'-6"	6'-6"	8'-0"	11'-0"	14'-6"	17'-6"		3'-6"	6'-6"	8'-6"	10'-0"	19'-0"	20'-0"	21'-0"	21'-6"	22'-0"	
24"	560D	2'-6"	4'-0"	5'-0"	5'-6"	7'-0"	8'-6"	11'-0"	13'-6"	16'-0"	17'-6"	5'-0"	7'-6"	9'-0"	10'-6"	14'-0"	20'-0"	21'-0"	21'-6"	22'-0"	22'-0"

■ Rectangular holes based on measurement of longest side.

How to Use These Tables

- Using **Table A**, **Table B**, or both if required, determine the hole shape/size and select the TJI® joist and depth.
- Scan horizontally until you intersect the correct hole size column.
- Measurement shown is minimum distance from edge of hole to support.
- Maintain the required minimum distance from the end **and** the intermediate or cantilever support.



General Notes

- Holes may be located vertically anywhere within the web. Leave 1/8" of web (minimum) at top and bottom of hole.
- Knockouts are located in web at approximately 12" on-center; they do not affect hole placement and may be located in the hatched zone.
- For simple span (5' minimum) uniformly loaded joists meeting the requirements of this guide, one maximum size round hole may be located at the center of the joist span **provided that no other holes occur in the joist**.
- Distances are based on the maximum uniform loads shown in this guide. For other load conditions or hole configurations, use ForteWEB® software or contact your Weyerhaeuser representative.



WARNING: This product can expose you to chemicals including wood dust which are known to the State of California to cause cancer, and methanol, which are known to the State of California to cause birth defects or other reproductive harm. Drilling, sawing, sanding or machining wood products can expose you to wood dust. Avoid inhaling wood dust or use a dust mask or other safeguards for personal protection. For more information go to www.P65Warnings.ca.gov and www.P65Warnings.ca.gov/wood.

Safety data sheets for all Weyerhaeuser wood products can be found on our website at: weyerhaeuser.com/sustainability/environment/product-stewardship/safety-data-sheets.

Maximum Horizontal Clear Spans—Roof (slopes of 3:12 or less)

O.C. Spacing	Depth	TJI®	Design Live Load (LL) and Dead Load (DL) in PSF							
			Non-Snow (125%)			Snow Load Area (115%)				
			20LL + 15DL	20LL + 20DL	25LL + 15DL	30LL + 15DL	40LL + 15DL	50LL + 15DL		
16"	18"	360	39'-8"	37'-11"	37'-11"	36'-5"	30'-9"	26'-0"		
		560, 560D	45'-6"	43'-5"	43'-6"	41'-9"	37'-6"	31'-8"		
	20"	360	43'-0"	41'-1"	41'-1"	37'-7"	30'-9"	26'-0"		
		560, 560D	49'-3"	47'-0"	47'-1"	45'-3"	37'-6"	31'-8"		
	22"	560D	53'-3"	50'-10"	50'-11"	48'-11"	45'-8"	42'-10"		
	24"	560D	56'-10"	54'-3"	54'-4"	52'-2"	48'-9"	45'-5"		
19.2"	18"	360	37'-3"	35'-7"	35'-3"	31'-4"	25'-7"	21'-7"		
		560, 560D	42'-9"	40'-9"	40'-10"	38'-2"	31'-3"	26'-5"		
	20"	360	40'-5"	38'-4"	35'-3"	31'-4"	25'-7"	21'-7"		
		560, 560D	46'-3"	44'-2"	43'-0"	38'-2"	31'-3"	26'-5"		
	22"	560D	50'-0"	47'-9"	47'-10"	45'-11"	42'-10"	39'-8"		
	24"	560D	53'-5"	51'-0"	51'-0"	49'-0"	45'-1"	41'-5"		
24"	18"	360	34'-6"	30'-7"	28'-2"	25'-0"	20'-5"	17'-3"		
		560, 560D	39'-7"	37'-4"	34'-4"	30'-6"	24'-11"	21'-1"		
	20"	360	35'-0"	30'-7"	28'-2"	25'-0"	20'-5"	17'-3"		
		560, 560D	42'-9"	37'-4"	34'-4"	30'-6"	24'-11"	21'-1"		
	22"	560D	46'-4"	44'-2"	44'-3"	42'-6"	38'-7"	35'-6"		
	24"	560D	49'-5"	47'-2"	47'-2"	44'-6"	40'-3"	37'-1"		

How to Use This Table

1. Determine appropriate live and dead load, and the load duration factor.
2. Scan down the column until you find a span that meets or exceeds the span of your application.
3. Select TJI® joist and on-center spacing.

General Notes

- Table is based on:
 - Uniform loads.
 - More restrictive of simple or continuous span.
 - Roof slopes of ¼:12 minimum, 3:12 maximum.
 - **18" and 20" TJI® joists:** Minimum bearing length of 1¾" end and 3½" intermediate (no web stiffeners).
 - **22" and 24" TJI® joists:** Minimum bearing length of 1¾" end and 3½" intermediate; web stiffeners required at all bearings.
- Total load values are limited to deflection of L/180 and live load is based on joist deflection of L/240.
- For continuous spans, ratio of short span to long span should be 0.4 or greater to prevent uplift.
- A support beam or wall at the high end is required. Ridge board applications do not provide adequate support.
- For flat roofs or other loading conditions not shown, refer to Weyerhaeuser software.

ROOF LOAD TABLE

Roof—115% and 125% Load Duration (PLF) (slopes of 3:12 or less)

Depth	TJI®	Total Load			Defl.			Total Load			Defl.			Total Load			Defl.		
		Snow 115%	Non-Snow 125%	Live Load L/240	Snow 115%	Non-Snow 125%	Live Load L/240	Snow 115%	Non-Snow 125%	Live Load L/240	Snow 115%	Non-Snow 125%	Live Load L/240	Snow 115%	Non-Snow 125%	Live Load L/240	Snow 115%	Non-Snow 125%	Live Load L/240
		Roof Joist Horizontal Clear Span																	
		8'			10'			12'			14'			16'			18'		
18"	360	277	301	*	223	242	*	186	202	*	159	173	*	140	152	*	124	135	*
	560, 560D	338	368	*	272	295	*	227	246	*	195	212	*	170	185	*	152	165	*
20"	360	277	301	*	223	242	*	186	202	*	159	173	*	140	152	*	124	135	*
	560, 560D	338	368	*	272	295	*	227	246	*	195	212	*	170	185	*	152	165	*
22"	560D	574	624	*	461	501	*	385	419	*	331	359	*	290	315	*	258	280	*
24"	560D	610	663	*	490	532	*	409	445	*	351	382	*	307	334	*	274	297	*
		20'			22'			24'			26'			28'			30'		
18"	360	112	122	*	102	111	*	93	101	*	86	94	*	80	87	*	75	81	*
	560, 560D	137	148	*	124	135	*	114	124	*	105	114	*	98	106	*	91	99	*
20"	360	112	122	*	102	111	*	93	101	*	86	94	*	80	87	*	75	81	*
	560, 560D	137	148	*	124	135	*	114	124	*	105	114	*	98	106	*	91	99	*
22"	560D	232	252	*	211	229	*	193	210	*	179	194	*	166	180	*	155	168	*
24"	560D	246	268	*	224	244	*	205	223	*	190	206	*	176	192	*	164	179	*

* Indicates that Total Load value controls.

How to Use These Tables

1. Calculate actual total load in pounds per linear foot (plf).
2. Select appropriate **Roof Joist Horizontal Clear Span**. For slopes of 2:12 and 3:12, approximate the increased dead load by multiplying the joist horizontal clear span by a slope factor of 1.014 and 1.031, respectively.
3. Scan down the column to find a TJI® joist that meets or exceeds actual total load.

General Notes

- Table is based on:
 - Uniform loads.
 - No composite action provided by sheathing.
 - More restrictive of simple or continuous span.
 - Roof slope of ¼:12 minimum, 3:12 maximum.
 - **18" and 20" TJI® joists:** Minimum bearing length of 1¾" end and 3½" intermediate (no web stiffeners).
 - **22" and 24" TJI® joists:** Minimum bearing length of 1¾" end and 3½" intermediate; web stiffeners required at all bearings.
- Total Load values are limited to deflection of L/180. For stiffer deflection criteria, use the Live Load L/240 values.

Cantilevers Less Than 5" (Brick Ledge)

See Section A of cantilever table on page 21

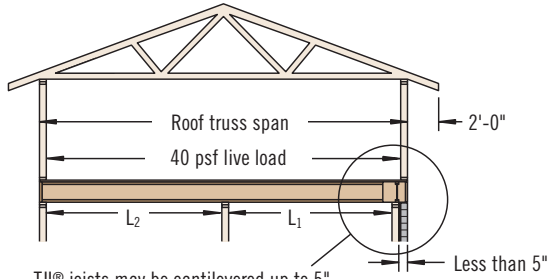

TJI® joists may be cantilevered up to 5" when supporting roof load, assuming:

- simple or continuous span
- $L_1 \leq L_2$
- minimum backspan = 2x cantilever length

Cantilevers 5" to 24"

See Section B of cantilever table on page 21

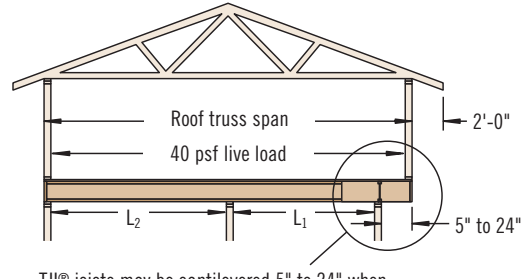

TJI® joists may be cantilevered 5" to 24" when supporting roof load, assuming:

- simple or continuous span
- $L_1 \leq L_2$
- minimum backspan = 2x cantilever length

PB1

Cantilever back span must be permanently braced with either direct-applied ceiling along entire length or permanent bracing at 1/3 points. See detail PB1 below for connections.

1/4" or 1/2" TimberStrand® LSL rim board, typical. Nail with (0.131" x 3") nails, one each at top and bottom flange.

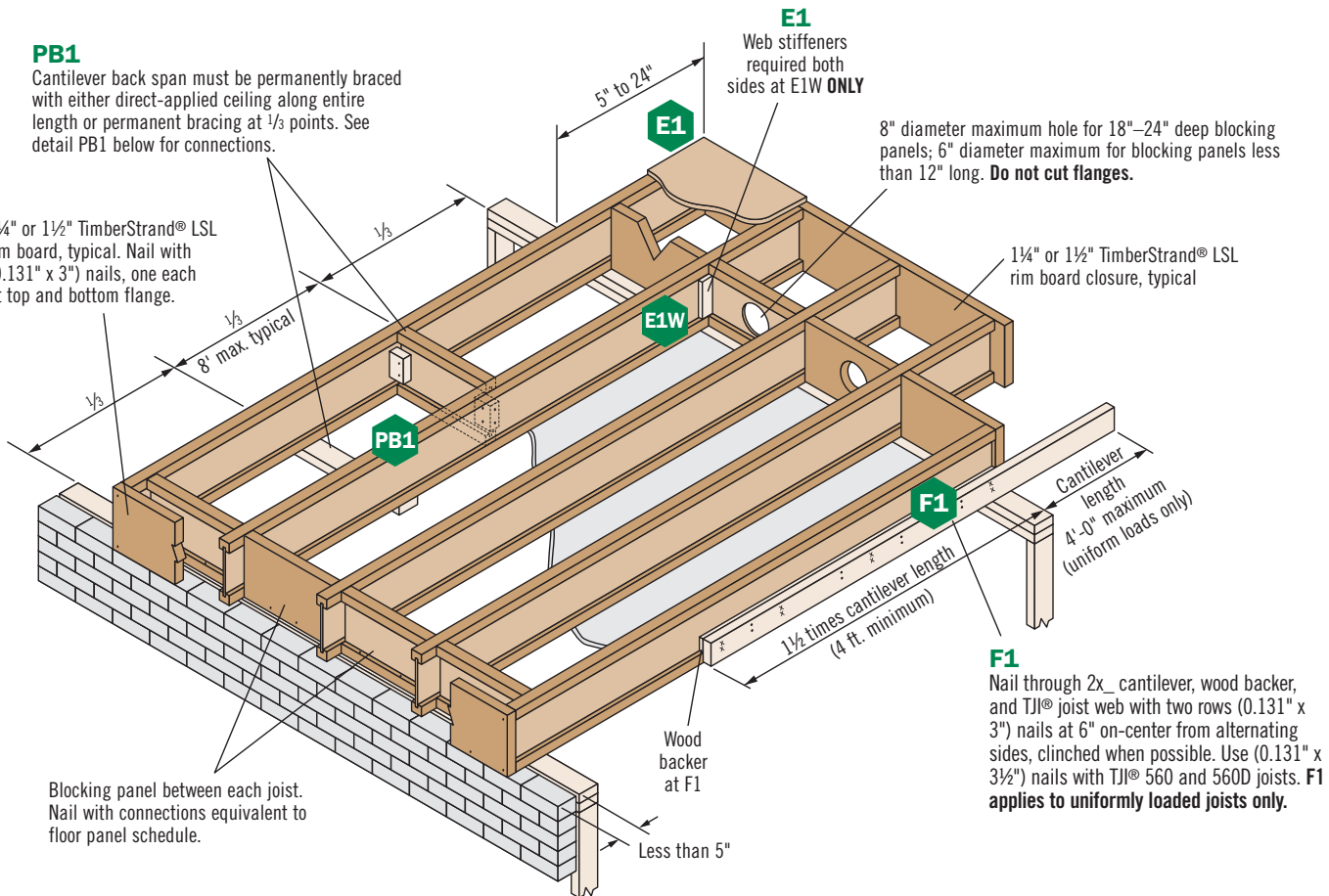

Blocking panel between each joist. Nail with connections equivalent to floor panel schedule.

Less than 5"

F1

Nail through 2x_ cantilever, wood backer, and TJI® joist web with two rows (0.131" x 3") nails at 6" on-center from alternating sides, clinched when possible. Use (0.131" x 3 1/2") nails with TJI® 560 and 560D joists. **F1 applies to uniformly loaded joists only.**

TJI® joists are intended for dry-use applications

Two 2 1/2" screws for 2x_ strapping connections

Apply subfloor adhesive to all contact surfaces

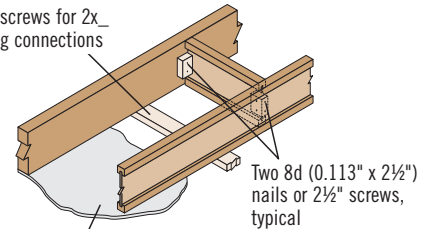

Directly applied ceiling

PB1

When specified on the layout, one of the above bracing options is required

For E1 and E1W details, also refer to our cover sheets and AutoCAD details online at weyerhaeuser.com/woodproducts/software-learning

Cantilever Reinforcement

Depth	TJI®	Roof Truss Span	Section A: Cantilevers less than 5" (Brick Ledge)									Section B: Cantilevers 5" to 24"										
			Roof Total Load									Roof Total Load										
			35 PSF			45 PSF			55 PSF			35 PSF			45 PSF			55 PSF				
			On-Center Joist Spacing									On-Center Joist Spacing										
16"	19.2"	24"	16"	19.2"	24"	16"	19.2"	24"	16"	19.2"	24"	16"	19.2"	24"	16"	19.2"	24"	16"	19.2"	24"		
18" or 20"	360	24'							X													
		26'							X													
		28'			X				X			X	X									
		30'			X				X			X	X									
		32'			X		X	X			X	X										
		34'			X		X	X	X	X	X	X										E1W
		36'			X		X	X	X	X	X	X										E1W
		38'		X	X		X	X	X	X	X	X							E1W			E1W
40'		X	X	X	X	X	X	X	X	X						E1W				X		
18" or 20"	560, 560D	24'																			X	
		26'																				X
		28'								X												X
		30'							X													X
		32'							X			X	X									X
		34'			X				X			X	X									X
		36'			X				X			X	X									X
		38'			X		X	X			X	X										X
40'			X		X	X	X	X	X	X										X		
22" or 24"	560D	24'	E1W	E1W	E1W	E1W	E1W	E1W	E1W	E1W	E1W	E1W	E1W	E1W	E1W	E1W	E1W	E1W	E1W	E1W	E1W	
		26'	E1W	E1W	E1W	E1W	E1W	E1W	E1W	E1W	E1W	E1W	E1W	E1W	E1W	E1W	E1W	E1W	E1W	E1W	E1W	E1W
		28'	E1W	E1W	E1W	E1W	E1W	E1W	E1W	E1W	E1W	E1W	E1W	E1W	E1W	E1W	E1W	E1W	E1W	E1W	E1W	E1W
		30'	E1W	E1W	E1W	E1W	E1W	E1W	E1W	E1W	E1W	E1W	E1W	E1W	E1W	E1W	E1W	E1W	E1W	E1W	E1W	E1W
		32'	E1W	E1W	E1W	E1W	E1W	E1W	E1W	E1W	E1W	E1W	E1W	E1W	E1W	E1W	E1W	E1W	E1W	E1W	E1W	E1W
		34'	E1W	E1W	E1W	E1W	E1W	E1W	E1W	E1W	E1W	E1W	E1W	E1W	E1W	E1W	E1W	E1W	E1W	E1W	E1W	E1W
		36'	E1W	E1W	E1W	E1W	E1W	E1W	E1W	E1W	E1W	E1W	E1W	E1W	E1W	E1W	E1W	E1W	E1W	E1W	E1W	E1W
		38'	E1W	E1W	E1W	E1W	E1W	E1W	E1W	E1W	E1W	E1W	E1W	E1W	E1W	E1W	E1W	E1W	E1W	E1W	E1W	E1W
40'	E1W	E1W	E1W	E1W	E1W	E1W	E1W	E1W	E1W	E1W	E1W	E1W	E1W	E1W	E1W	E1W	E1W	E1W	E1W	E1W		

How to Use This Table

1. Identify TJI® joist and depth.
2. Locate the **Roof Truss Span** (horizontal) that meets or exceeds your condition.
3. Identify the cantilever condition (less than 5" or 5" to 24") and locate the **Roof Total Load** and **On-Center Joist Spacing** for your application.
4. Scan down to find the appropriate cantilever detail and refer to drawing on page 20:
 - Blank cells indicate that no reinforcement is required.
 - X indicates that cantilever will not work. Use ForteWEB® or Javelin® software, or reduce spacing of joists and recheck table.

General Notes

- Table is based on:
 - 15 psf roof dead load on a horizontal projection.
 - 80 plf exterior wall load with 3'-0" maximum width window or door openings. For larger openings, or multiple 3'-0" width openings spaced less than 6'-0" on-center, additional joists beneath the opening's trimmers may be required.
 - Floor load of 40 psf live load and 10 psf dead load.
 - More restrictive of simple or continuous span.
 - Roof truss with 24" soffits.
- Designed for 2x4 and 2x6 plate widths.
- For conditions beyond the scope of this table, including cantilevers longer than 24", use our ForteWEB® or Javelin® software.

See page 20 for cantilever details

These Conditions are **NOT** Permitted:



DO NOT use sawn lumber for rim board or blocking as it may shrink after installation. Use only engineered lumber

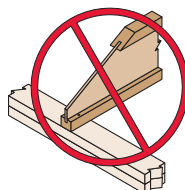

DO NOT bevel cut joist beyond inside face of wall.

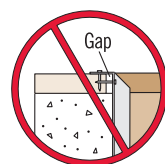

DO NOT install hanger overhanging face of plate or beam. Flush bearing plate with inside face of wall or beam.

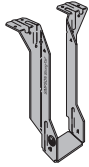

Single Joist, Top Mount



Single Joist, Face Mount

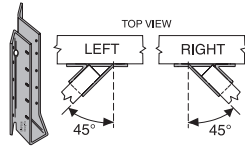

Face Mount Skewed 45° Joist Hanger



Double Joist, Top Mount



Double Joist, Face Mount

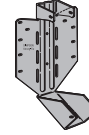

Variable Slope Seat Joist Hanger

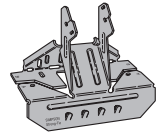

Variable Slope Seat Connector

Joist		Single Joist—Top Mount				Single Joist—Face Mount ⁽¹⁾				Face Mount Skewed 45° Joist Hanger			
Depth	TJI®	Hanger	Capacity (lbs)	Nailing		Hanger	Capacity (lbs)	Nailing		Hanger	Capacity (lbs)	Nailing	
				Header	Joist			Header	Joist			Header	Joist
18"	360	MIT3518	1,265	16d	10d x 1½"	MIU2.37/18	1,260	16d	10d x 1½"	<i>SUR/L2.37/14</i>	1,430	16d	10d x 1½"
	560, 560D	MIT418	1,460	16d	10d x 1½"	MIU3.56/18	1,460	16d	10d x 1½"	<i>SUR/L414</i>	1,495	16d	16d
20"	360	MIT3520	1,265	16d	10d x 1½"	MIU2.37/20	1,260	16d	10d x 1½"	<i>SUR/L2.37/14</i>	1,430	16d	10d x 1½"
	560, 560D	MIT420	1,460	16d	10d x 1½"	MIU3.56/20	1,460	16d	10d x 1½"	<i>SUR/L414</i>	1,495	16d	16d
22"	560D	<i>HIT422</i>	2,220	16d	10d x 1½"	<i>MIU3.56/20</i>	2,555	16d	10d x 1½"	<i>SUR/L414⁽⁶⁾</i>	2,400	16d	16d
24"	560D	<i>HIT424</i>	2,220	16d	10d x 1½"	<i>MIU3.56/20</i>	2,555	16d	10d x 1½"	<i>SUR/L414⁽⁶⁾</i>	2,400	16d	16d

Joist		Double Joist—Top Mount				Double Joist—Face Mount ⁽¹⁾			
Depth	TJI®	Hanger	Capacity (lbs)	Nailing		Hanger	Capacity (lbs)	Nailing	
				Header	Joist			Header	Joist
18"	360	<i>BA4.75/18</i>	2,765	16d	10d x 1½"	<i>MIU4.75/18</i>	2,525	16d	10d x 1½"
	560, 560D	<i>HB7.12/18</i>	3,450	16d	16d	<i>HU414-2</i>	2,925	16d	16d
20"	360	<i>BA4.75/20</i>	2,765	16d	10d x 1½"	<i>MIU4.75/20</i>	2,525	16d	10d x 1½"
	560, 560D	<i>HB7.12/20</i>	3,450	16d	16d	<i>HU414-2</i>	2,925	16d	16d
22"	560D	<i>HB7.12/22</i>	5,395	16d	16d	<i>HU414-2</i>	2,975	16d	16d
24"	560D	<i>HB7.12/24</i>	5,395	16d	16d	<i>HU414-2⁽⁶⁾</i>	2,975	16d	16d

Hanger information on this page was provided by either Simpson Strong-Tie® or USP Structural Connectors®. For additional information, please refer to their literature.

Joist		Variable Slope Seat Joist Hanger ⁽³⁾⁽⁶⁾				
Depth	TJI®	Hanger	Capacity (lbs)		Nailing	
			Sloped Only	Sloped and Skewed	Header	Joist
18"-20"	360	<i>LSSR2.37Z</i>	1,110	1,060	10d	10d x 1½"
	560, 560D	<i>LSSR410Z</i>	1,300	1,300	16d	16d
22"-24"	560D	<i>LSSR410Z</i>	2,365	1,810	16d	16d

Joist		Variable Slope Seat Connector ⁽²⁾			
Depth	TJI®	Hanger	Capacity (lbs)	Nailing	
				Header	Joist
18"-20"	360	VPA35	1,140	10d	10d x 1½"
	560, 560D	VPA4	1,245	10d	10d x 1½"
22"-24"	560D	VPA4	1,245	10d	10d x 1½"

General Notes

Bold italic hangers require web stiffeners.

Capacities will vary with different nailing criteria or other support conditions; contact your Weyerhaeuser representative for assistance.

- Hanger capacities shown are either joist bearing capacity or hanger capacity—whichever is less. Joist end reaction must be checked to ensure it does not exceed the capacity shown in the tables.
- All capacities are for downward loads at 100% duration of load.
- Fill all round, dimple, and positive-angle nail holes.
- Use sloped seat hangers and beveled web stiffeners when TJI® joist slope exceeds ¼ :12. **Maximum slope for 18"-24" joists is 3:12.**
- Leave ⅛" clearance (½" maximum) between the end of the supported joist and the header or hanger.
- Nails: 16d = 0.162" x 3½", 10d = 0.148" x 3", and 10d x 1½" = 0.148" x 1½".

Also see additional notes on page 23

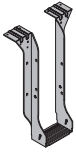

Single Joist,
Top Mount

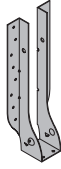

Single Joist,
Face Mount

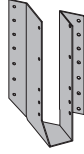

Face Mount Skewed
45° Joist Hanger

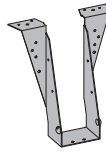

Double Joist,
Top Mount

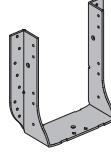

Double Joist,
Face Mount

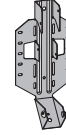

Variable Slope Seat
Joist Hanger

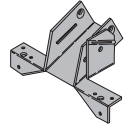

Variable Slope
Seat Connector

Joist		Single Joist—Top Mount				Single Joist—Face Mount ⁽¹⁾				Face Mount Skewed 45° Joist Hanger			
Depth	TJI®	Hanger	Capacity (lbs)	Nailing		Hanger	Capacity (lbs)	Nailing		Hanger	Capacity (lbs)	Nailing	
				Header	Joist			Header	Joist			Header	Joist
18"	360	TFI3518	1,260	16d	10d x 1½"	IHF2318 ⁽¹⁾	1,260	10d	10d x 1½"	SKH2324L/R	1,110	10d	10d x 1½"
	560, 560D	TFI418	1,460	16d	10d x 1½"	IHF3518 ⁽¹⁾	1,460	10d	10d x 1½"	SKH414L/R ⁽⁴⁾	1,460	16d	16d
20"	360	TFI3520	1,260	16d	10d x 1½"	IHF2318 ⁽¹⁾	1,260	10d	10d x 1½"	SKH2324L/R ⁽⁶⁾	1,110	10d	10d x 1½"
	560, 560D	TFI420	1,460	16d	10d x 1½"	IHF3518 ⁽¹⁾	1,460	10d	10d x 1½"	SKH414L/R ⁽⁴⁾	1,460	16d	16d
22"	560D	TFI422	2,555	16d	10d x 1½"	IHF3518	1,750	10d	10d x 1½"	SKH414L/R ⁽⁴⁾⁽⁶⁾	2,555	16d	16d
24"	560D	TFI424	2,555	16d	10d x 1½"	IHF3518	1,750	10d	10d x 1½"	SKH414L/R ⁽⁴⁾⁽⁶⁾	2,555	16d	16d

Joist		Double Joist—Top Mount				Double Joist—Face Mount			
Depth	TJI®	Hanger	Capacity (lbs)	Nailing		Hanger	Capacity (lbs)	Nailing	
				Header	Joist			Header	Joist
18"	360	THO23180-2	2,765	16d	10d	THF23160-2 ⁽¹⁾	2,525	10d	10d
	560, 560D	BPH7118	3,075	16d	10d	HD7160 ⁽¹⁾	2,925	16d	10d
20"	360	THO23200-2	2,765	16d	10d	THF23160-2 ⁽¹⁾	2,525	10d	10d
	560, 560D	BPH7120	3,075	16d	10d	HD7160 ⁽¹⁾	2,925	16d	10d
22"	560D	BPH7122	3,075	16d	10d	HD7160	3,695	16d	10d
24"	560D	BPH7124	3,075	16d	10d	HD7160	3,695	16d	10d

Joist		Variable Slope Seat Joist Hanger ⁽³⁾⁽⁶⁾				
Depth	TJI®	Hanger	Capacity (lbs)		Nailing	
			Sloped Only	Sloped and Skewed	Header	Joist
18"—20"	360	LSSH23	1,200	1,200	10d	10d x 1½"
	560, 560D	LSSH35	1,595	1,595	16d	10d x 1½"
22"—24"	560D	LSSH35	2,645	1,610	16d	10d x 1½"

Joist		Variable Slope Seat Connector ⁽⁵⁾			
Depth	TJI®	Hanger	Capacity (lbs)	Nailing	
				Header	Joist
18"—20"	360	TMP23	1,505	10d	10d x 1½"
	560, 560D	TMP4	1,705	10d	10d x 1½"
22"—24"	560D	TMP4	1,705	10d	10d x 1½"

Table Footnotes:

- (1) Face mount hanger capacities may be increased up to 15% for snow roofs or 25% for non-snow roofs.
- (2) For joist depths 18" and deeper, use only at a 3:12 slope.
- (3) For TJI® joist depths 18" and deeper, use only up to a 3:12 slope; skew up to 45 degrees. Additional lateral restraints are required for 18"—24" deep TJI® joists.
- (4) Miter cut is required at end of joists.
- (5) For joist depths 18" and deeper, use only on slopes 1:12 through 3:12.
- (6) Additional lateral restraints are required.

Support Requirements

- Support material assumed to be Trus Joist® engineered lumber or sawn lumber (Douglas fir or southern pine species).
- Minimum support width for single- and double-joist top mount hangers is 3".
- Minimum support width for face mount hangers with 10d and 16d nails (clinched) is 1½" and 1¾", respectively.

See General Notes on page 22

SECTION 3: DESIGN INFORMATION FOR ALL JOISTS

This section contains framing details and design information applicable to all joist depths shown in this guide.

TJI® Joist Floor Framing

TJI® joist floor framing does not require bridging or mid-span blocking

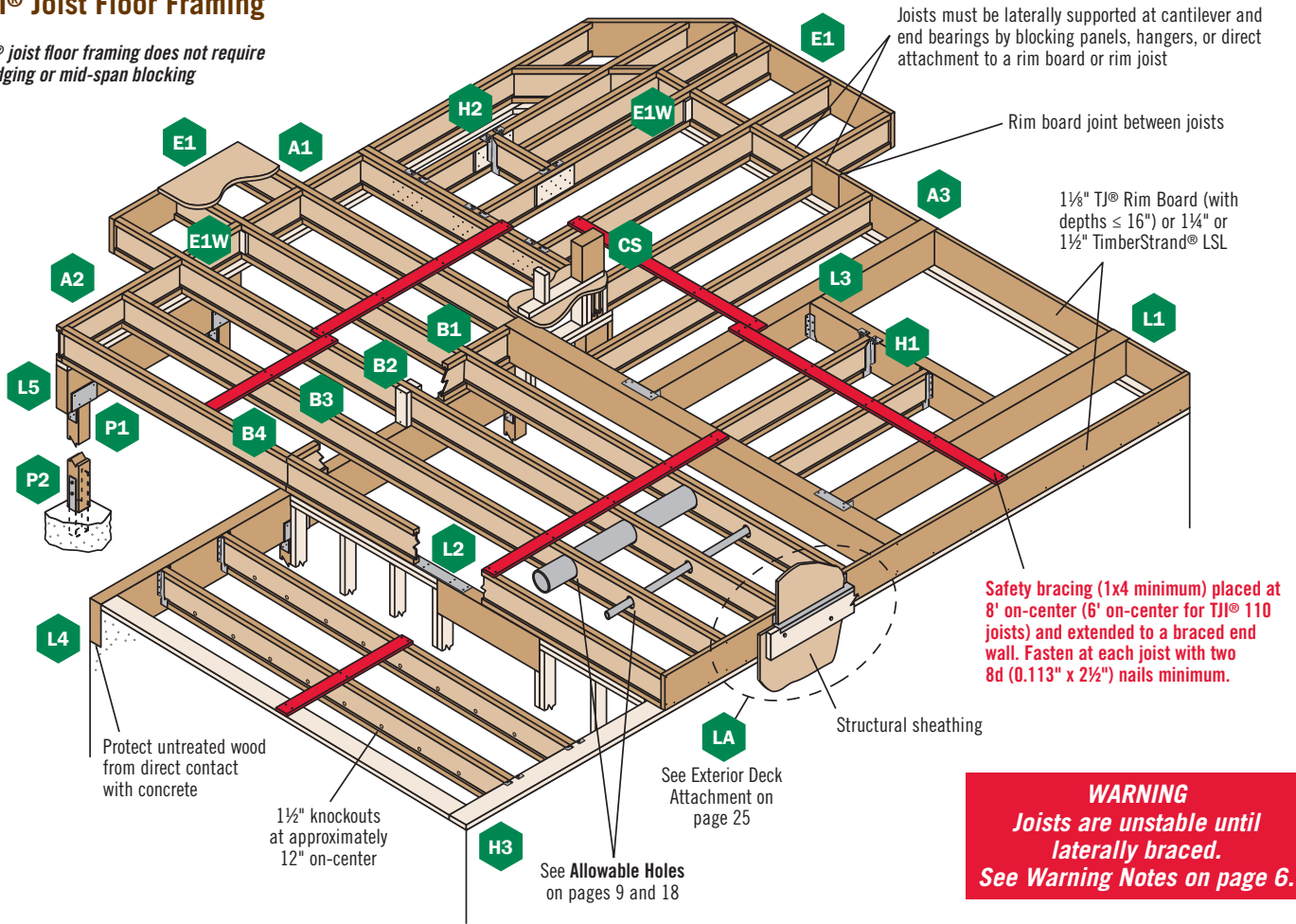

WARNING
Joists are unstable until laterally braced.
See Warning Notes on page 6.

TJI® Joist Nailing Requirements at Bearing

TJI® Joist to Bearing Plate

1½" TJI® Rim Board (with depths ≤ 16"), or ¼" or ½" TimberStrand® LSL

Use one 8d (0.113" x 2½") nail each side. Drive nails at an angle of at least 1½" from end. For TJI® 560D, use (0.131" x 3") nails.

Shear transfer nailing:
Use connections equivalent to floor panel nailing schedule

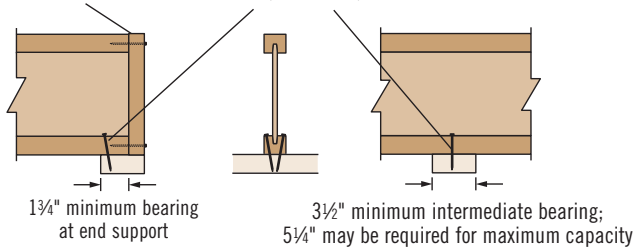

Squash Blocks to TJI® Joist (Load bearing wall above)

One (0.131" x 3") nail into each flange

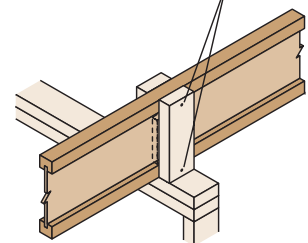

Also see detail B2 on page 26

Rim to TJI® Joist

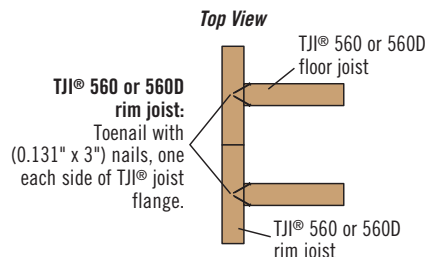
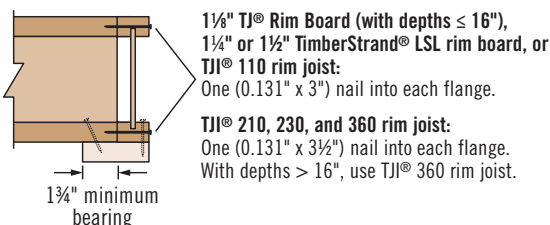

Locate rim board joint between joists

Rim board is often an important structural link in the ability of a home to resist lateral seismic and wind loads. It also transfers vertical load around the TJI® joists. Rim board detail A3 (shown below) satisfies conventional construction requirements. But if your project requires a designed solution, see Weyerhaeuser's *Rim Board Specifier's Guide, TJ-8000*, which features additional information on rim board selection and installation.

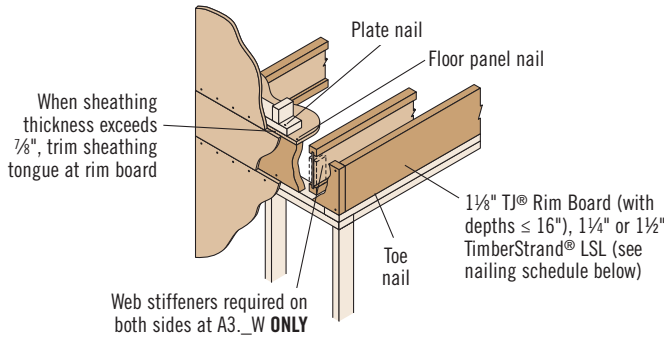

A3 **A3.1** **A3.2** **A3.3** **A3 W** **A3.1 W** **A3.2 W** **A3.3 W**

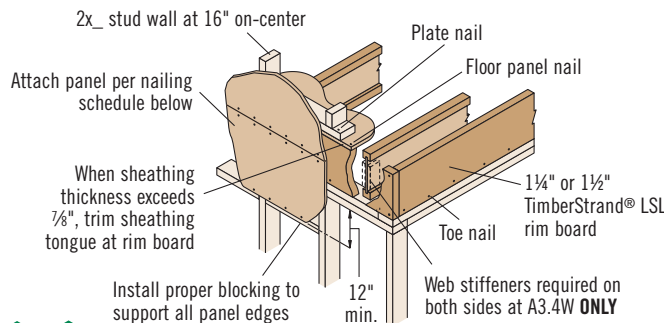

A3.4 **A3.4 W**

Rim Board Installation

Specifications	A3, Conventional Construction, Code Minimum	A3.1, A3.2, A3.3, A3.4 Designed Solution
Rim Board Thickness	1 1/8" TJI® Rim Board, or 1 1/4" or 1 1/2" TimberStrand® LSL	See Weyerhaeuser's <i>Rim Board Specifier's Guide</i> (Reorder #TJ-8000)
Plate Nail: (0.131" x 3")	12" o.c. ⁽¹⁾	
Floor Panel Nail: 8d (0.131" x 2 1/2")	6" o.c.	
Toe Nail: (0.131" x 3")	6" o.c.	
Wall Sheathing	Per code	

(1) Per code, increase nailing to 4" on center for braced walls.

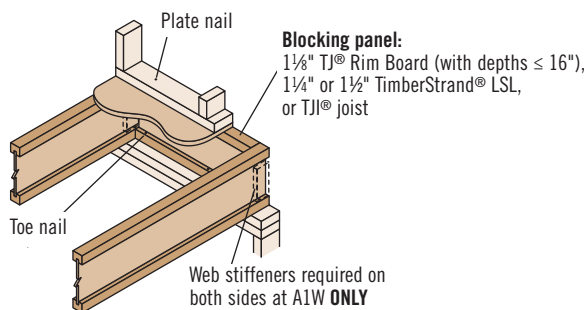

A1 **A1 W**

Attach blocking per fastening instructions in Detail A3.

Exterior Deck Attachment

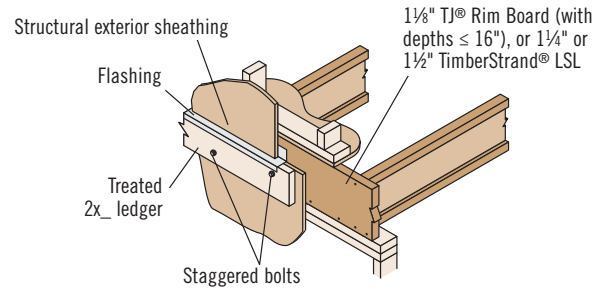

Shimmed Deck Attachment

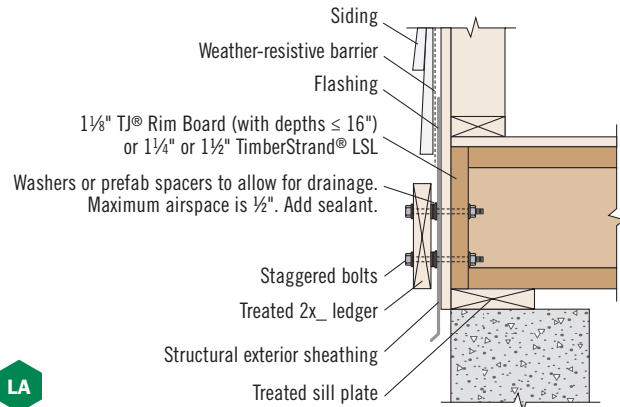

LA

Ledger Fastener⁽¹⁾ Capacities

Rim Board Material	Fastener Allowable Load ⁽²⁾ (lbs/bolt)		
	1/2" Lag Bolt	1/2" Through Bolt	1/2" Through Bolt with Air Space
1 1/8" TJI® Rim Board ⁽³⁾	480	695	615 ⁽⁴⁾
1 1/4" TimberStrand® LSL	610	725	
1 1/2" TimberStrand® LSL	675	725	

(1) Corrosion-resistant fasteners required in wet-service applications.

(2) Allowable load determined in accordance with ASTM D7672.

(3) 1 1/8" TJI® Rim Board is allowed with joist depths ≤ 16" only.

(4) Maximum 1/2" shimmed air space.

General Notes

- Maintain 2" distance (minimum) from edge of ledger to fastener. Stagger bolts.
- Local building codes may require through bolts with washers.
- Lateral restraining connections may be required. Refer to 2015 IRC R507.2.4 and 2018 IRC R507.9.2 and the WIJMA deck connection details.
- See Weyerhaeuser's *Rim Board Specifier's Guide, TJ-8000*, for more information.

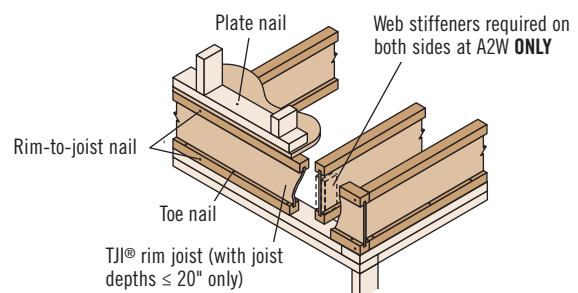

A2 **A2 W**

Must have 1 3/4" minimum joist bearing at ends. Attach rim joist per fastening instructions in Detail A3.

Also see nailing requirements on page 24

Load bearing or braced/shear wall above (must stack over wall below)

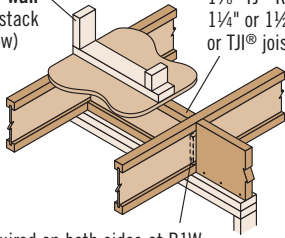

Blocking panel: 1 1/8" TJI® Rim Board (with depths ≤ 16"), 1/4" or 1/2" TimberStrand® LSL, or TJI® joist

Web stiffeners required on both sides at B1W ONLY. See footnote (1) under span tables.

B1 B1 W

IRC 502.7 requires lateral restraint (blocking) at all intermediate supports in Seismic Design Categories D₀, D₁, and D₂ to strengthen the floor diaphragm

Load bearing wall above (must stack over wall below)

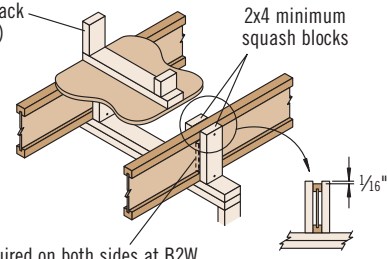

Web stiffeners required on both sides at B2W ONLY. See footnote (1) under span tables.

B2 B2 W

Blocking panels may be required in Seismic Design Categories D₀, D₁, and D₂ and/or with braced/shear walls above or below—see detail B1

No load bearing wall above

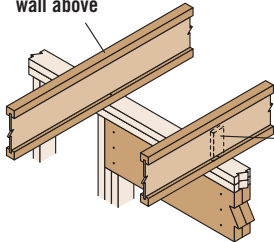

Web stiffeners required on both sides at B3W ONLY. See footnote (1) under span tables.

B3 B3 W

Blocking panels may be required in Seismic Design Categories D₀, D₁ and D₂ and/or with braced/shear walls above or below—see detail B1

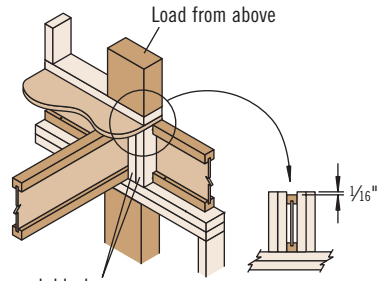

2x4 minimum squash blocks; match bearing area of column above

CS

Use 2x4 minimum squash blocks to transfer load around TJI® joist

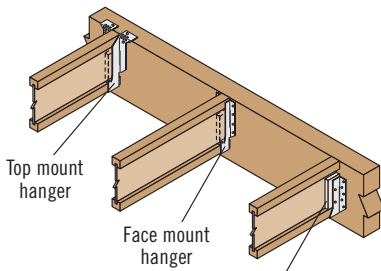

Web stiffeners required if sides of hanger do not laterally support at least 3/8" of TJI® joist top flange

H1

Flush bearing plate required. Maximum 1/4" overhang permitted at beam.

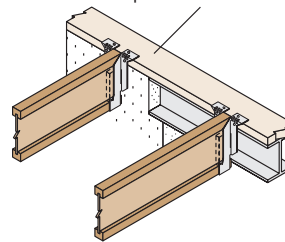

H3

FASTENER SPACING AND DIAPHRAGM DESIGN

TJI®	Closest On-Center Spacing per Row ⁽¹⁾⁽²⁾			Diaphragm Design Information
	8d (0.113" x 2 1/2"), 8d (0.131" x 2 1/2"), 10d (0.128" x 3"), 12d (0.128" x 3 1/4")	10d (0.148" x 3"), 12d (0.148" x 3 1/4"), 16d (0.135" x 3 1/2")	16d (0.162" x 3 1/2")	
110 and 210	4"	4" ⁽³⁾	6"	See ICC-ES ESR-1153
230	4"	4" ⁽³⁾	6"	
360, 560 and 560D	3"	4" ⁽³⁾	6"	

(1) Stagger nails when using 4" on-center spacing or less and maintain 3/8" joist and panel edge distance. One row of fasteners is permitted (two at abutting panel edges) for diaphragms. Fastener spacing for TJI® joists in diaphragm applications cannot be less than shown in table. When fastener spacing for blocking is less than above, rectangular blocking must be used in lieu of TJI® joists.

(2) For non-diaphragm applications, multiple rows of fasteners are permitted if the rows are offset at least 1/2" and staggered.

(3) Can be reduced to 3" on-center for light gauge steel straps with 10d (0.148" x 1 1/2") nails.

- Maximum spacing of nails is 18" on-center.
- 14 gauge staples may be substituted for 8d (0.113" x 2 1/2") nails if minimum penetration of 1" is achieved.
- Table also applies to the attachment of TJI® rim joists and blocking panels to the wall plate.

Also see nailing requirements on page 24

Filler and Backer Block Sizes

TJI®	110		210		230 or 360		360	560			560D
Depth	9½"–11⅞"	14"–16"	9½"–11⅞"	14"–16"	9½"–11⅞"	14"–16"	18"–20"	11⅞"	14"–16"	18"–20"	22"–24"
Filler Block ⁽¹⁾ (Detail H2)	2x6	2x8	2x6 + ⅜" sheathing	2x8 + ⅜" sheathing	2x6 + ½" sheathing	2x8 + ½" sheathing	2x12 + ½" sheathing	Two 2x6	Two 2x8	Two 2x12	Four ¾" x 15" sheathing
Cantilever Filler (Detail E4)	2x6 4'-0" long	2x10 6'-0" long	2x6 + ⅜" sheathing, 4'-0" long	2x10 + ⅜" sheathing, 6'-0" long	2x6 + ½" sheathing, 4'-0" long	2x10 + ½" sheathing, 6'-0" long	Not applicable	Not applicable			
Backer Block ⁽¹⁾ (Detail F1 or H2)	⅝" or ¾"		¾" or ⅞"		⅞" or 1" net			2x6	2x8	2x12	Two ¾" x 15" sheathing
Nail Size	Filler	(0.131" x 3")						(0.131" x 3½")			
	Backer	(0.131" x 3")						(0.131" x 3")			
Nail Quantity ⁽²⁾	Filler	15						32			50
	Backer	15						15			15

- If necessary, increase filler and backer block height for face mount hangers and maintain ⅛" gap at top of joist. See detail W on page 27. Filler and backer block dimensions should accommodate required nailing without splitting. The suggested minimum length is 24" for filler and 12" for backer blocks.
- Clinch nails when possible.
- For filler block connections, drive nails from alternating sides.

Nails Installed on the Narrow Face

Nail Size	Closest On-Center Spacing per Row		
	1⅞" TJI® Rim Board ⁽¹⁾	TimberStrand® LSL	
		1¼"	1½"
8d (0.113" x 2½"), 10d (0.128" x 3"), 12d (0.128" x 3¼")	6"	4"	3"
10d (0.148" x 3"), 12d (0.148" x 3¼")	6"	4"	3"
16d (0.162" x 3½")	16" ⁽²⁾	6" ⁽³⁾	6" ⁽³⁾
(0.131" x 3"-3½")	6"	4"	3"

- 1⅞" TJI® Rim Board is allowed with joist depths ≤ 16" only.
 - Can be reduced to 5" on-center if nail penetration into the narrow edge is no more than 1¼" (to minimize splitting).
 - Can be reduced to 4" on-center if nail penetration into the narrow edge is no more than 1¼" (to minimize splitting).
- To minimize splitting, maintain edge distance and row spacing of 2½ x nail diameter or ⅜", whichever is greater. Multiple rows must be staggered and equally spaced from the centerline of the narrow face axis.
 - 14 gauge staples may be substituted for 8d (0.113" x 2½") nails if minimum penetration of 1" is achieved.

Vertical Load Transfer at Bearing

Rim Board or Blocking Material	Depth	Allowable Uniform Vertical Load (PLF)	Concentrated Load (lbs)
TJI® 110, 210, 230, 360, 560	9½"–16"	2,100	
TJI® 360		1,550	
TJI® 560	18"–20"	1,550	–
TJI® 560D		2,250 ⁽¹⁾	
TJI® 560D (blocking only)	22"–24"	1,700 ⁽¹⁾	
1⅞" TJI® Rim Board or blocking	9½", 11⅞"	4,860 ⁽²⁾	4,150
	14"		
	16"		
1¼" TimberStrand® LSL	9½"–14"	5,400 ⁽²⁾	3,760
	16"	5,000	
	18"	4,340	
	20"	3,700	
	22"	3,160	
1½" TimberStrand® LSL	9½"–16"	6,480 ⁽²⁾	4,520
	18"	6,380	
	20"	5,740	
	22"	5,070	
	24"	4,440	

- Capacity is based on calculation
 - Capacity is limited to a maximum of 360 psi per ASTM D7672
- Loads shall not be increased for duration of load.

Backer block: Install tight to top flange (tight to bottom flange with face mount hangers). Attach per table above.

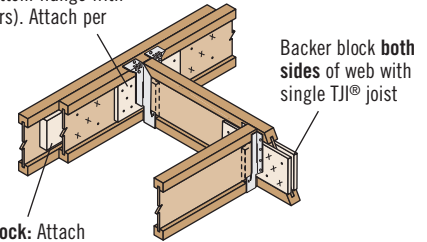

Filler block: Attach per table above.

Backer block **both sides** of web with single TJI® joist

H2 With top mount hangers, backer block required only for downward loads exceeding 250 lbs or for uplift conditions

Web Stiffener Attachment

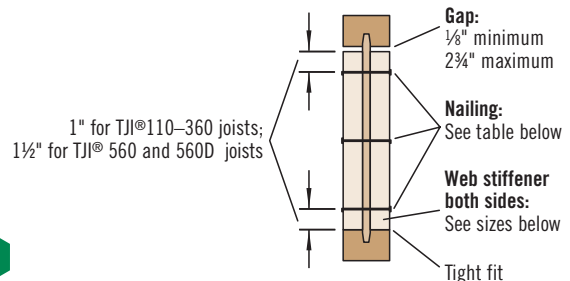

1" for TJI®110–360 joists;
1½" for TJI® 560 and 560D joists

Gap:
⅛" minimum
¾" maximum

Nailing:
See table below

Web stiffener both sides:
See sizes below

Tight fit

Web Stiffener Requirements

TJI®	Depth (in.)	Minimum Web Stiffener Size	Nail Type	# of Nails	
				End	Int.
110	All	⅝" x 2 5/16" ⁽¹⁾	8d (0.113" x 2½")	3	3
210	All	¾" x 2 5/16" ⁽¹⁾		3	3
230, 360	All	⅞" x 2 5/16" ⁽¹⁾		3	3
560	All	2x4 ⁽²⁾	16d (0.135" x 3½")	3	3
560D	18"	2x4 ⁽²⁾	16d (0.135" x 3½")	4	4
	20"			5	5
	22" ⁽³⁾			6	11
	24" ⁽³⁾			6	13

- PS1 or PS2 sheathing, face grain vertical
- Construction grade or better
- Web stiffeners are always required for 22" and 24" TJI® 560D joists.

Also see nailing requirements on page 24

WARNING
Joists are unstable until laterally braced.
See Warning Notes on page 6.

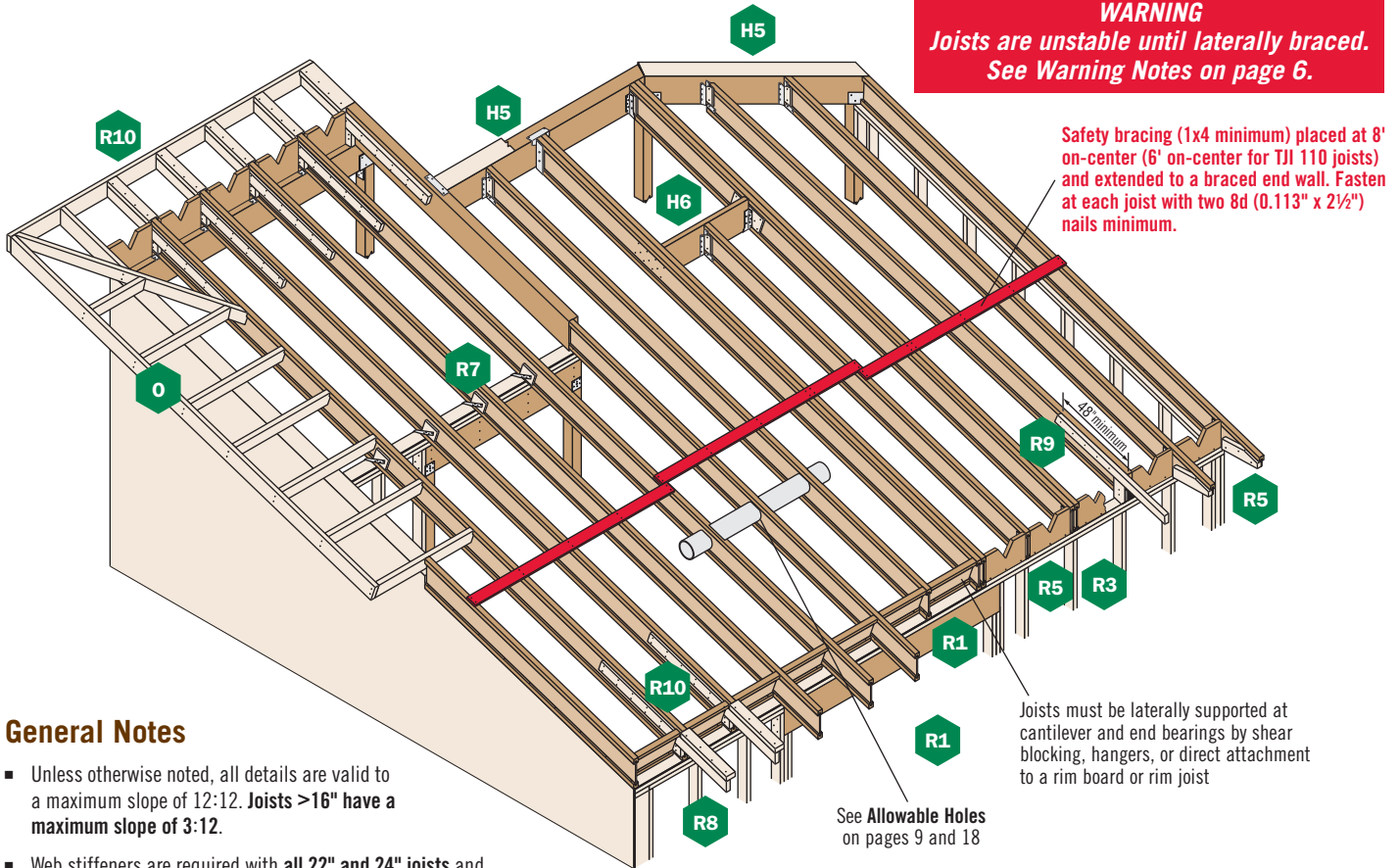

General Notes

- Unless otherwise noted, all details are valid to a maximum slope of 12:12. Joists >16" have a maximum slope of 3:12.
- Web stiffeners are required with all 22" and 24" joists and when the sides of the hanger do not laterally support at least 3/8" of the TJI® joist top flange. Also see framing plan.

TJI® Joist Nailing Requirements at Bearing (Maximum slope for 18"-24" joists is 3:12)

TJI® Joist to Bearing Plate

End Bearing
(1 3/4" minimum bearing required)

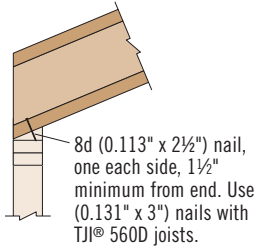

When slope exceeds 1/4:12, a beveled bearing plate, variable slope seat connector, or birdsmouth cut (at low end of joist only) is required.

Intermediate Bearing
(3 1/2" minimum bearing required)

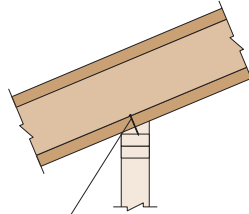

Slopes 3:12 or less:
One 8d (0.113" x 2 1/2") nail each side. Use (0.131" x 3") nails with TJI® 560D joists. See detail R7.
Slopes greater than 3:12 (for depths ≤ 16" only):
Two 8d (0.113" x 2 1/2") nails each side, plus a twist strap and backer block. See detail R7S.

When slope exceeds 1/4:12 for a 2x4 wall or 1/8:12 for a 2x6 wall, a beveled bearing plate or variable slope seat connector is required.

Blocking to Bearing Plate

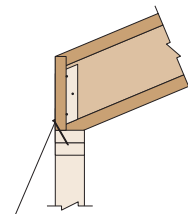

1 1/4" TJI® Rim Board (with depths ≤ 16"), or 1 1/4" or 1 1/2" TimberStrand® LSL:
Toenail with (0.131" x 3") nails at 6" on-center.
TJI® joist blocking:
(0.131" x 3") nails at 6" on-center
Shear transfer nailing:
Minimum, use connections equivalent to sheathing nail schedule

These Conditions Are NOT Permitted:

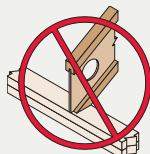

DO NOT cut holes too close to support.
Refer to Allowable Holes on pages 9 and 18 for minimum distance from support.

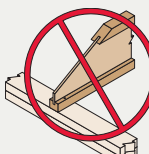

DO NOT bevel cut joist beyond inside face of wall.

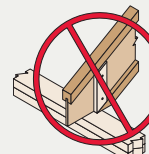

DO NOT overhang birdsmouth cut from inside face of plate.
TJI® joist flange must bear fully on the plate. See detail BC on page 30.

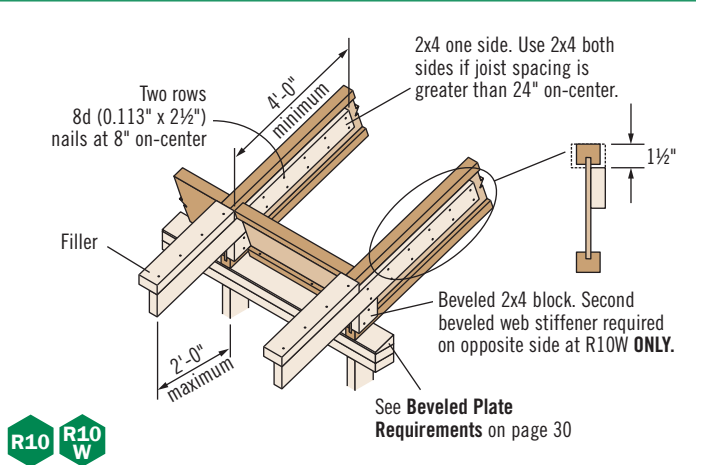
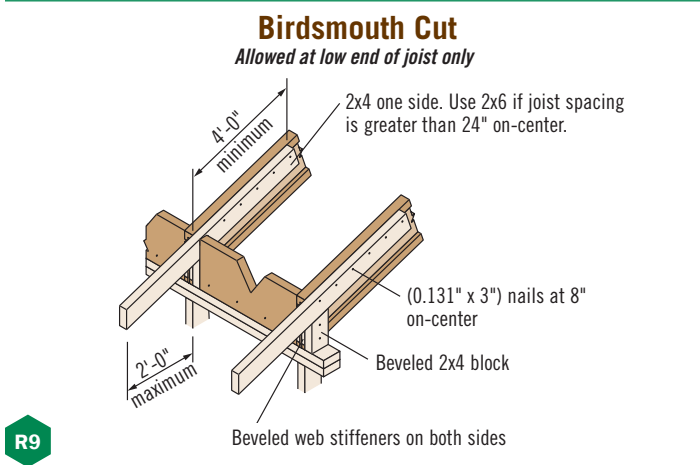
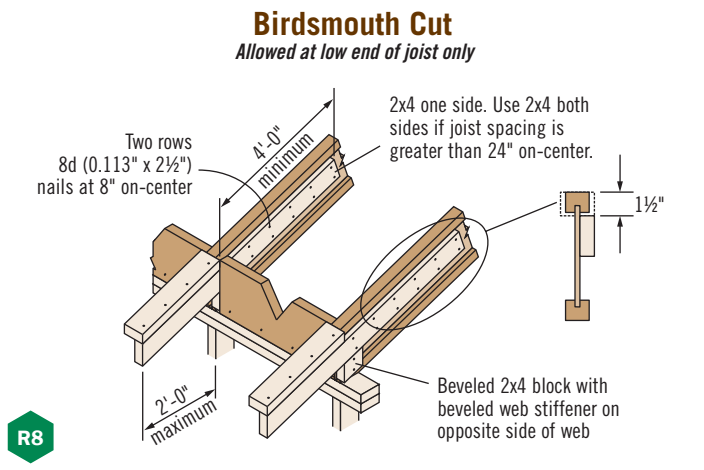
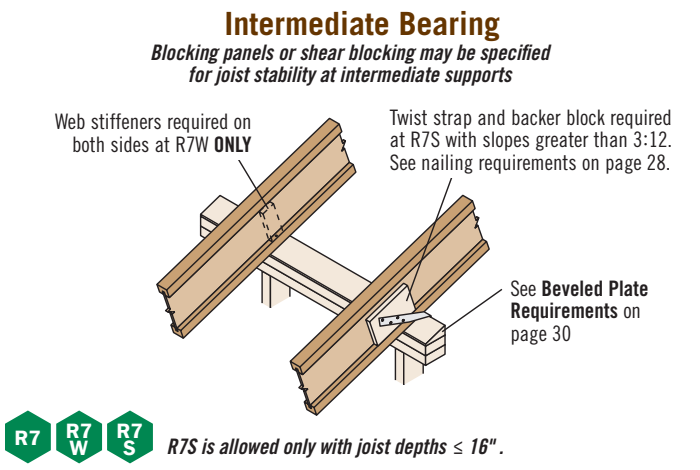
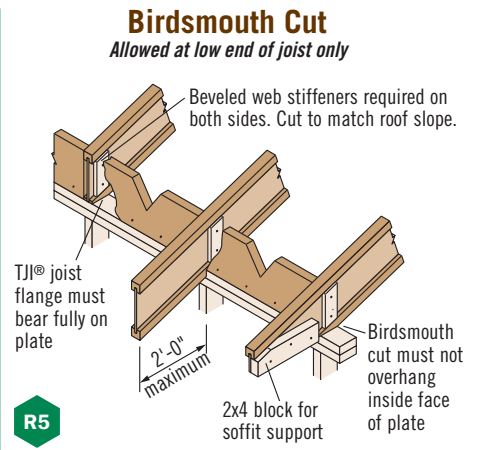
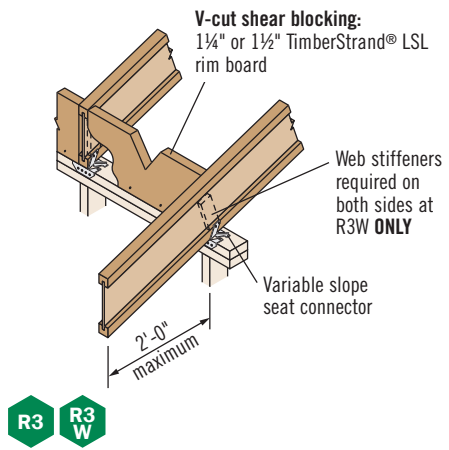
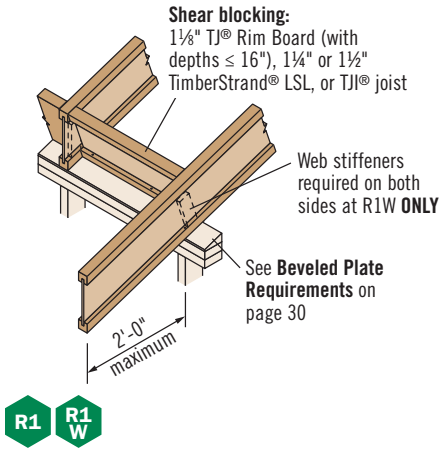

Shear Blocking and Ventilation Holes (Roof Only)

Field trim to match joist depth at outer edge of wall or locate on wall to match joist depth. Use 1½" TJI® Rim Board with depths ≤ 16".

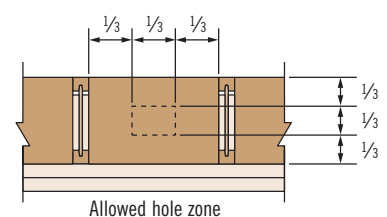
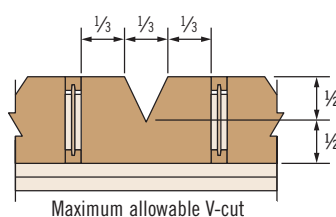
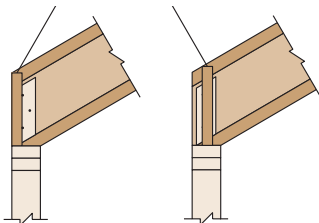

SB For TJI® joists with slopes of 10:12 to 12:12, the vertical depth of the shear blocking at bearing will require 1½" TJI® Rim Board or 1¼" or 1½" TimberStrand® LSL that is one size deeper than the TJI® joist. DO NOT use 1½" TJI® Rim Board with 18"-24" TJI® joists or in ventilation-hole applications.

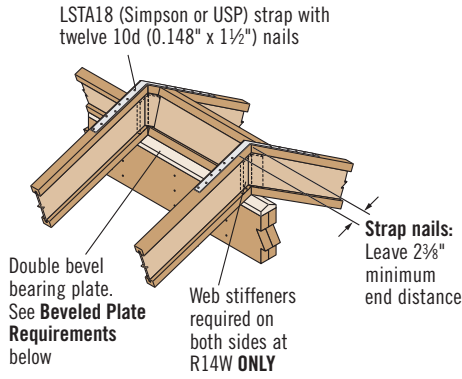

R14 R14 W

Additional blocking may be required for shear transfer

O

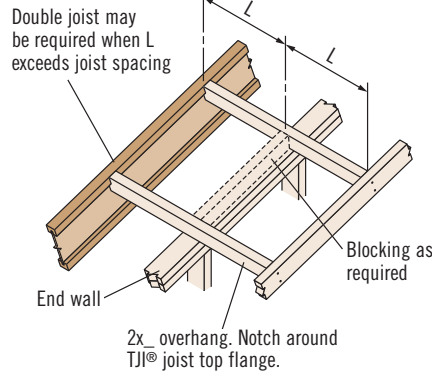

Birdsmouth Cut

Allowed at low end of joist only

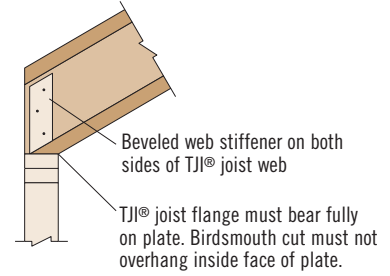

BC

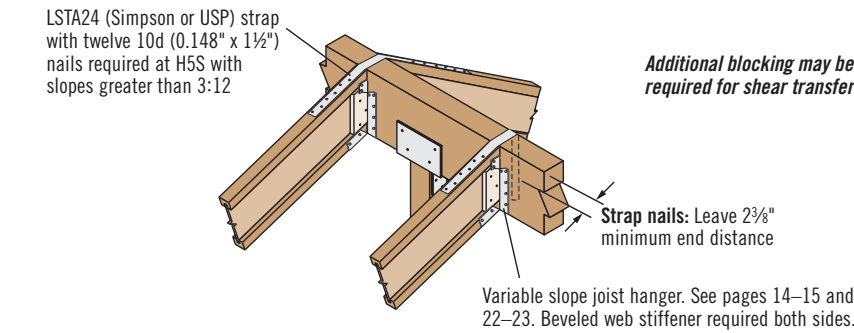

H5 H5S

Detail H5S is allowed only with joist depths ≤ 16".

Beveled Plate Requirements

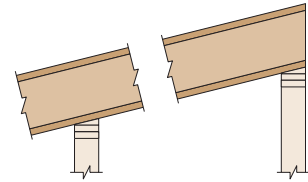

Required Bearing Length	Maximum Slope Without Beveled Plate
1 3/4"	1/2:12
3 1/2"	1/4:12
5 1/2"	1/8:12

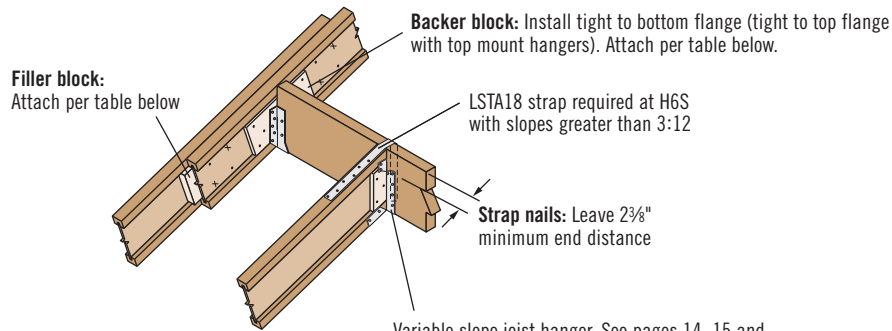

H6 H6S

Detail H6S is allowed only with joist depths ≤ 16".

Variable slope joist hanger. See pages 14–15 and 22–23. Beveled web stiffener required both sides.

Filler and Backer Block Sizes

TJI®	110		210		230 or 360		360	560		560 or 560D	560D	
Depth	9 1/2"–11 1/8"	14"–16"	9 1/2"–11 1/8"	14"–16"	9 1/2"–11 1/8"	14"–16"	18"–20"	11 1/8"	14"–16"	18"–20"	22"–24"	
Filler Block ⁽¹⁾ (Detail H6)	2x6	2x8	2x6 + 3/8" sheathing	2x8 + 3/8" sheathing	2x6 + 1/2" sheathing	2x8 + 1/2" sheathing	2x12 + 1/2" sheathing	Two 2x6	Two 2x8	Two 2x12	Four 3/4" x 15" sheathing	
Backer Block ⁽¹⁾ (Detail H6)	5/8" or 3/4"		3/4" or 7/8"		7/8" or 1" net			2x6	2x8	2x12	Two 3/4" x 15" sheathing	
Nail Size	Filler	(0.131" x 3")						(0.131" x 3 1/2")				
	Backer							(0.131" x 3")				
Nail Quantity ⁽²⁾	Filler	15						32		50		
	Backer	15						15		15		

(1) If necessary, increase filler and backer block height for face mount hangers and maintain 1/8" gap at top of joist. See detail W on page 27. Filler and backer block dimensions should accommodate required nailing without splitting. The suggested minimum length is 24" for filler and 12" for backer blocks.
 (2) Clinch nails when possible.
 (3) For filler block connections, drive nails from alternating sides.

Also see nailing requirements on page 28

CUT LENGTH CALCULATION

ALL JOIST DEPTHS

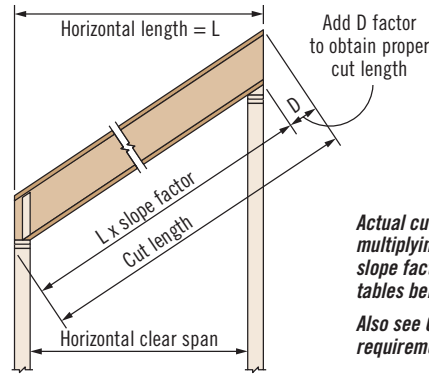

Actual cut length can be approximated by multiplying the horizontal length by the slope factor and adding the D factor. See tables below.

Also see General Notes and nailing requirements on page 28.

D Factors

Depth	Slope															
	1:12	1½:12	2:12	2½:12	3:12	3½:12	4:12	4½:12	5:12	6:12	7:12	8:12	9:12	10:12	11:12	12:12
9½"	7/8"	1¼"	1⅝"	2"	2⅜"	2⅞"	3¼"	3⅝"	4"	4¾"	5⅝"	6⅜"	7⅞"	8"	8¾"	9½"
11⅞"	1"	1½"	2"	2½"	3"	3½"	4"	4½"	5"	6"	7"	8"	9"	10"	11"	11⅞"
14"	1¼"	1¾"	2⅜"	3"	3½"	4⅛"	4¾"	5¼"	5⅞"	7"	8¼"	9⅜"	10½"	11¾"	12⅞"	14"
16"	1⅝"	2"	2¾"	3⅜"	4"	4¾"	5⅜"	6"	6¾"	8"	9⅜"	10¾"	12"	13⅜"	14¾"	16"
18"	1½"	2¼"	3"	3¾"	4½"	N.A.										
20"	1⅝"	2½"	3⅜"	4⅛"	5"											
22"	1⅞"	2¾"	3⅝"	4⅜"	5½"											
24"	2"	3"	4"	5"	6"											

Slope Factors

Slope	2½:12	3:12	3½:12	4:12	4½:12	5:12	6:12	7:12	8:12	9:12	10:12	11:12	12:12
Factor	1.021	1.031	1.042	1.054	1.068	1.083	1.118	1.158	1.202	1.250	1.302	1.357	1.414

MATERIAL WEIGHTS AND CONVERSION TABLE

Material Weights

(Include TJI® weights in dead load calculations—see Design Properties tables on pages 6 and 16 for joist weights)

Floor Panels

Southern Pine

½" plywood	1.7 psf
⅝" plywood	2.0 psf
¾" plywood	2.5 psf
1⅛" plywood	3.8 psf
½" OSB	1.8 psf
⅝" OSB	2.2 psf
¾" OSB	2.7 psf
⅞" OSB	3.1 psf
1⅛" OSB	4.1 psf

Based on: Southern pine – 40 pcf for plywood, 44 pcf for OSB

Roofing

Asphalt shingles	2.5 psf
Wood shingles	2.0 psf
Clay tile	9.0 to 14.0 psf
Slate (¾" thick)	15.0 psf

Roll or Batt Insulation (1" thick):

Rock wool	0.2 psf
Glass wool	0.1 psf

Floor Finishes

Hardwood (nominal 1")	4.0 psf
Sheet vinyl	0.5 psf
Carpet and pad	1.0 psf
¾" ceramic or quarry tile	10.0 psf

Concrete:

Regular (1")	12.0 psf
Lightweight (1")	8.0 to 10.0 psf
Gypsum concrete (¾")	6.5 psf

Ceilings

Acoustical fibre tile	1.0 psf
½" gypsum board	2.2 psf
⅝" gypsum board	2.8 psf
Plaster (1" thick)	8.0 psf

PSF to PLF

O.C. Spacing	Load in Pounds Per Square Foot (PSF)								
	20	25	30	35	40	45	50	55	60
12"	20	25	30	35	40	45	50	55	60
16"	27	34	40	47	54	60	67	74	80
19.2"	32	40	48	56	64	72	80	88	96
24"	40	50	60	70	80	90	100	110	120

WE CAN HELP YOU BUILD SMARTER

You want to build solid and durable structures—we want to help. Weyerhaeuser provides high-quality building products and unparalleled technical and field assistance to support you and your project from start to finish.

Floors and Roofs: Start with the best framing components in the industry: our Trus Joist® TJI® joists; TimberStrand® LSL rim board; and TimberStrand® LSL, Microllam® LVL, and Parallam® PSL headers and beams. Pull them all together with our self-gapping and self-draining Weyerhaeuser Edge Gold™ floor panels and durable Weyerhaeuser roof sheathing.

Walls: Get the best value out of your framing package—use TimberStrand® LSL studs for tall walls, kitchens, and bathrooms, and our traditional, solid-sawn lumber everywhere else. Cut down installation time by using TimberStrand® LSL headers for doors and windows, and Weyerhaeuser wall sheathing with its handy two-way nail lines.

Software Solutions: Whether you are a design professional or lumber dealer, Weyerhaeuser offers an array of software packages to help you specify individual framing members, create cut lists, manage inventories—even help you design a complete structural frame. Contact your Weyerhaeuser representative to find out how to get the software you need.

Technical Support: Need technical help? Weyerhaeuser has one of the largest networks of engineers and sales representatives in the business. Call us for help, and a skilled member from our team of experts will answer your questions and work with you to develop solutions that meet all your structural framing needs.

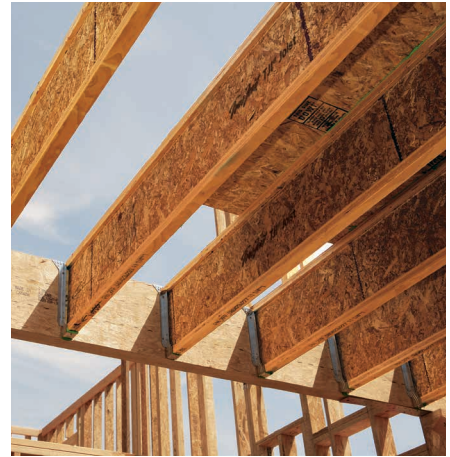

LIMITED LIFETIME PRODUCT WARRANTY

Weyerhaeuser provides a limited warranty for the expected life of the structure for all Trus Joist® branded products. Product information, installation instructions, and the full text of each product's limited warranty (including limitations and exclusions) are available on the Weyerhaeuser website, from your Weyerhaeuser representative, or by calling toll free: 888-453-8358.

Additionally, Weyerhaeuser offers limited warranties on a broad variety of its other products. To see complete details of all Weyerhaeuser product warranties, visit weyerhaeuser.com/woodproducts/warranty.

1.888.453.8358 [WEYERHAEUSER.COM/WOODPRODUCTS](http://weyerhaeuser.com/woodproducts)



Revised 10/2022 January 2023. ▲ Weyerhaeuser and Trus Joist are registered trademarks of Weyerhaeuser NR. © 2023 Weyerhaeuser NR Company. All rights reserved. California residents: For address or other personal information we collect and/or for other purposes, please visit weyerhaeuser.com/privacy.

CONTACT US

1.888.453.8358 • weyerhaeuser.com/woodproducts/contact

Contact your local representative or dealer at:

Visit weyerhaeuser.com/woodproducts/warranty for copies of this and other Trus Joist® Engineered Wood Product warranties.

February 2023 • Reorder TJ-4000

This document supersedes all previous versions. If this is more than one year old, contact your dealer or Weyerhaeuser representative.

▲ Weyerhaeuser, Flak Jacket, ForteWEB, Javelin, Microllam, Parallam, TimberStrand, TJ, TJI, and Trus Joist are registered trademarks and Edge Gold, and TJ-Pro are trademarks of Weyerhaeuser NR Company. © 2023 Weyerhaeuser NR Company. All rights reserved. Printed in the USA.